

VZ-9.4 Visualizer Systems



Driving the Creation of Knowledge

VZ-9.4F and VZ-9.4L Desktop Visualizer Systems



WolfVision is a worldwide provider of products and services to leading universities, businesses, schools, and other organizations. An acknowledged 'technology leader' in the Visualizer and presentation solutions market, WolfVision is the company that takes the lead, setting standards worldwide for innovative, reliable, user-friendly, high performance presentation solutions.

Our VZ-9.4 Series Visualizer systems offer highly effective imaging, enabling quick and efficient handling of multimedia presentation content. In addition to their impressive ability to display both 'live' material and external content from a wide variety of sources, VZ-9.4 Series systems are the first WolfVision desktop units to feature onboard HD video capture with audio, which allows for recording of complete multimedia presentations and lectures. The difference between the two models is that the VZ-9.4F features a 1080p HD camera, and the VZ-9.4L comes with a native WXGA/720p HD camera and Synchronized Lasermarkers for easy positioning of objects.



Our extensive knowledge and expertise across all application sectors enables us to offer comprehensive consultative guidance on customized combinations of Visualizer hardware systems, software, and accessories, which enhance communication, collaboration, and knowledge sharing across all environments. As part of each individual **✓Solution** we offer not only pre-sales advice, but also post-sales support, training and service, ensuring that you receive maximum benefit from your investment.

Driving the Creation of Knowledge.



reddot design award
best of the best 2010

Our Vision

When you've got something to say, we believe it is important that getting your message across and making an impact should be as easy as possible.

Our aim is to help you to explain it better, to give you the freedom to share your knowledge and collaborate with others - however you want, and whenever you want, when your audience is in the same room or on the other side of the world.

**Because knowledge matters -
to all of us.**



Outstanding Imaging Performance

WolfVision Visualizers are well-known for their unrivalled imaging quality, which is due to the perfect combination of high quality components and remarkable expertise. Our systems deliver high resolution throughout the entire picture, true-to-life colors, and consistently high frame rates to ensure smoothness of motion. They have fast and accurate autofocus and zooming, giving high quality dependable results every time! High end lenses provide distortion-free images, and high tech lighting systems deliver smooth and consistent lighting without distracting reflections or hot spots.

WolfVision's state-of-the-art YSOP1 image processing engine enables the fast and efficient processing of high volumes of data ensuring the consistent real-time display of impressive high definition pictures with unsurpassed levels of accuracy and detail.

High End Optics

Large premium quality lenses provide unrivalled imaging performance.



Image Sensor

WolfVision's high resolution image sensors ensure the capture of image data of the highest quality.

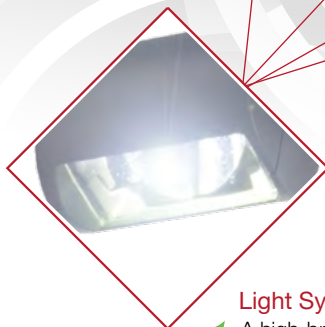
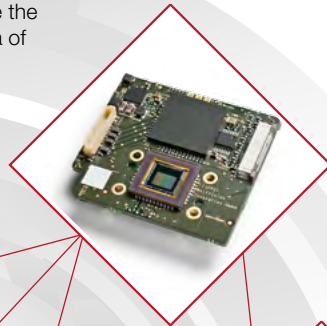

Light System

 A high-brightness LED lamp with low power consumption provides smooth and consistent lighting for accurate color reproduction.

Electronic Hardware

High quality components deliver high performance, stability, and reliability.

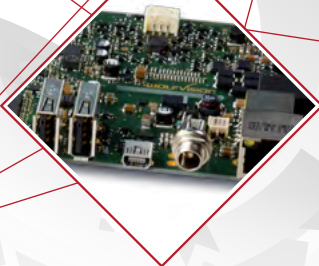

Software (Firmware)

Sophisticated software maximises the hardware potential to guarantee excellent picture quality.



++ Video ++

Unique Features

Powerful HD Cameras

The VZ-9.4F has a 1-CMOS native 1080p HD camera with up to 60 frames per second. The VZ-9.4L has a 1-CCD HD camera with 30 frames per second and 720p HD and WXGA native image formats.

Large Zoom Range

16x optical zoom gives great flexibility in presentations - objects as large as an open book or as small as a postage stamp can easily be picked up, and for enlarging even smaller objects, a 4x digital zoom is also provided.

Easy to Use / Zoom Wheel

For basic operation, users only need to use the zoom wheel on top of the camera head (or the zoom keys on the remote control) as all other controls such as focus, brightness, etc., are adjusted automatically.

Power Over Ethernet Plus (PoE+)

The LAN port provides Power over Ethernet Plus (PoE+), and is compatible with devices meeting the IEEE 802.3at standard. PoE+ is a popular way of saving on cables and installation costs.

Synchronized Lasermarkers (VZ-9.4L only)

Small dots of laser light, projected from the camera head onto the working surface mark the 16:9 edges of the pickup area of the camera. The lasermarkers are synchronized with the camera and adjust accordingly when zooming in and out.

Large Preview Monitor

A built-in widescreen preview monitor makes it very easy to position objects correctly on the working surface.

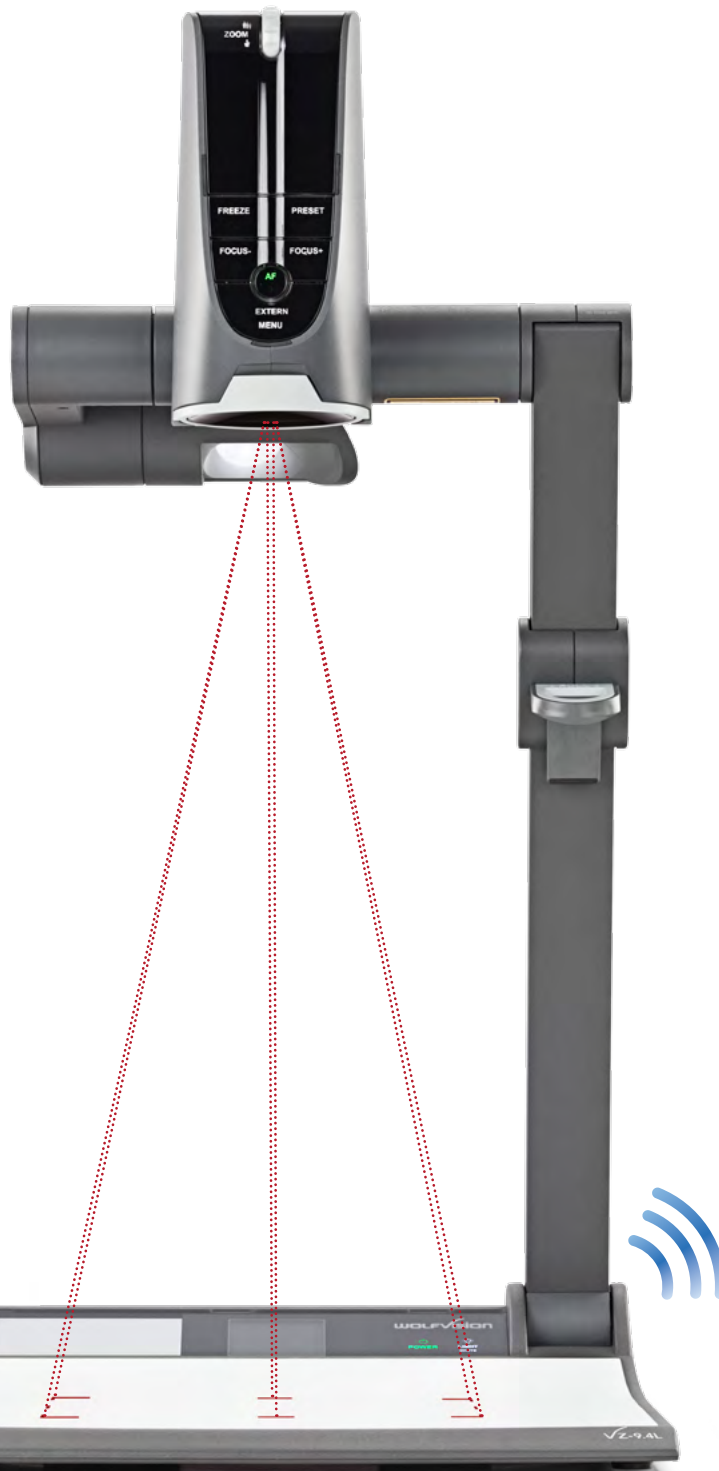

Built-In Microphone / Line In

A built-in microphone is provided for recording audio, and a line level input also allows for external audio sources to be recorded if required.



+ 3D Model +

Recording Made Easy

HD Video Recording

VZ-9.4F and VZ-9.4L Visualizers feature onboard recording functionality that allows entire presentations and lectures to be captured including the audio. They offer the quickest and easiest solution for in-house production of training videos or lecture capture. There's no need to set up a tripod, lights, microphones, or anything else. The VZ-9.4 Series Visualizers offer an impressive 'all-in-one HD recording solution'.

The easy-to-use interface requires no advanced technical knowledge, and by using the pause button, multiple segments of a presentation can be recorded and saved as a single file, eliminating the need for subsequent editing and time-consuming post-production.

In addition to the built-in microphone, a line level input is also provided for situations where the capture of external audio is preferred.



Creating Unique Multimedia Presentations

The recording functionality of the VZ-9.4 Series is not limited to the Visualizer's own camera and microphone. External content such as PowerPoint, digital images, webpages, PDF's, etc. from a

PC or tablet connected to one of the Visualizer's HDMI In ports can be easily recorded together with voiceover audio in 720p HD resolution with a frame rate of up to 30 fps.



Flexible Memory Options

Recorded videos and pictures can be saved to the 8GB Visualizer system internal memory which has enough capacity to store thousands of images, or an average of 10 hours of video

footage (depending on the content). Alternatively USB sticks or external hard drives can also be used to provide additional storage space if required.

User-friendly Operation

More Recording Options - Rotating Camera Head!

VZ-9.4 Visualizer systems can record almost anywhere in front of or behind the unit. The rotating camera head allows recordings to be made from virtually any

angle, and high-grade mechanical components ensure a stable mount for the camera. This ensures shake-free recordings in all camera positions.



Write on your Visualizer!

Self-adhesive dry-erase working surfaces are available as optional accessory items. When fixed to the working surface you can write onto, and erase directly from the Visualizer working surface using

suitable whiteboard markers and erasers. This enables the Visualizer to be used as a whiteboard or 'digital flip chart', and of course this handwritten material can also be included in recordings.



Intuitive Positioning - Synchronized Lasermarkers

Positioning an object correctly on the Visualizer working surface whilst talking to an audience at the same time is not always easy! The VZ-9.4L is easier to operate than other Desktop Visualizers because its Synchronized Lasermarkers allow for simple 'one-step' positioning of objects. Placing items to be displayed between the laser guides

that clearly mark the exact pick-up area of the camera eliminates the need for a presenter to make multiple checks between object and preview monitor or display screen in order to confirm accurate positioning of materials. This unique and popular feature gives presenters the freedom to concentrate fully on their presentation and audience.



Innovative Sharing Options



Efficient Knowledge Transfer via Streaming

VZ-9.4 Series Visualizer systems or connected WolfVision vSolution Link software can stream video and audio to computers, tablets or smartphones on the internal network or the internet using either H.264, Motion JPEG, or RTP Motion JPEG modes. An external device receiving the Visualizer's stream can also be used as a larger control monitor.

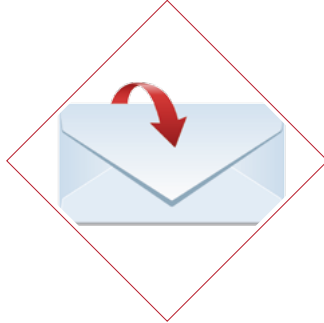

Quick and Convenient Distribution

WolfVision offers several possibilities for taking snapshots with VZ-9.4 systems, and emailing or printing them using our software components. This facilitates quick and easy distribution of materials during a presentation when required.



Easy Cloud Storage / FTP Upload

vSolution Connect software for iPad facilitates uploading and downloading of material to and from Dropbox. When using vSolution Connect during a presentation, content stored in Dropbox is always easily available. Adjustable Visualizer settings also enable videos and pictures to be either automatically or manually uploaded directly from the VZ-9.4 Series Visualizers to an FTP server if required.



Flexible Network Integration

Wired or Wireless Network Connection

For maximum stability and reliability, VZ-9.4 Visualizers can be connected to existing wired LAN infrastructure using encrypted security. Ethernet functionality of the Visualizer can be restricted and access can be password protected. For quick and easy installation, VZ-9.4 Series Visualizers can also be integrated into existing wireless LAN infrastructure using encrypted security.

Wireless Encryption

VZ-9.4 Series Visualizers support WEP, WPA and WPA2 wireless encryption. This allows for straightforward integration into the enterprise level IT networks commonly found in universities and other organizations, and ensures that no compromises in network security are required.

Single User Authentication

When using a smartphone or iPad with the Visualizer, Single User Authentication ensures a quick and easy wireless connection between device and Visualizer, and prevents any third party from interrupting the connection during a presentation.

Wireless Connectivity (Access Point)

VZ-9.4 Visualizers can also be configured to operate using an encrypted ad-hoc wireless network. This 'standalone' option allows for the direct wireless connection of smartphone, tablet, and PC devices, and means that full bandwidth is available for Visualizer use. It gives users maximum flexibility, particularly if a Visualizer is required to be used in multiple locations.



Bring Your Own Device

✓Solution Connect for tablets

Sync your WolfVision Visualizer with vSolution Connect, our powerful app for iOS, and Android tablets. Using this multimedia control dashboard enables all media types to be integrated and controlled using a single device. Content materials can easily be prepared in advance and added seamlessly into presentations when required.

The app also allows entire presentations including any external content to be recorded, and saved to the tablet memory. A Live Image Preview shows exactly what the audience sees on-screen at all times, and wireless connectivity allows presentations or lectures to be delivered from anywhere in the room.

The annotation feature is ideal for making notes, sketching, and highlighting documents, charts, and pictures. A dedicated whiteboard function also provides a separate space for making and displaying notes on-screen during a presentation.



Transforming Presentations

√Solution Control for Smartphones



The vSolution Control App enables WolfVision Visualizers to connect to an iPhone, Windows 8, Windows Phone 8 or Android device via WLAN. This intuitive and easy to use app allows presenters to use the device keypad and Live Image Preview to control a presentation or lecture wirelessly whilst moving freely around a room.

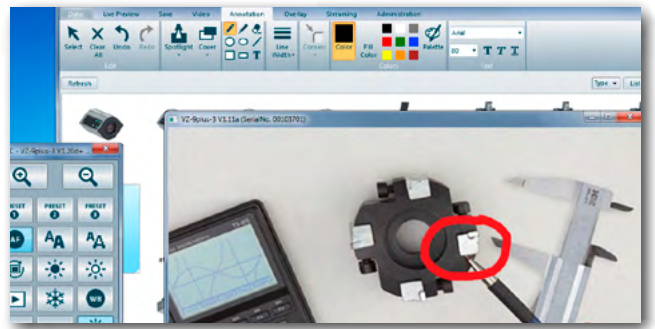

√Solution Link for PC and Mac

vSolution Link allows a user to connect a computer directly to a Visualizer. This software allows for saving, printing and emailing of images, recording of videos, adding annotations and video streaming. It also provides useful tools for automatically applying Visualizer firmware updates, allowing new features and technical improvements to be added at no cost!



			
Fast Multimedia Source Switching	✓	✓	✓
Visualizer Remote Control	✓	✓	✓
Live Image preview	✓	✓	✓
Image Snapshot	✓	✓	✓
Video Recording	✗	✓	✓
Image Annotation	✗	✓	✓
Live Web Streaming	✗	✗	✓
Access to Web-based Material	✗	✓	✓
Display Content From Device	✗	✓	✓
Multiple Source Preview	✗	✓	✗



Technical Data

	VZ-9.4F	VZ-9.4L
Camera	1-CMOS 1/3" Progressive Scan	1-CCD 1/3" Progressive Scan
Pictures per second (as picked up by the camera)	60 frames (in all resolutions)	30 frames (in all resolutions)
Effective Pixel (=pixels actually used for image information)	1920 x 1080 (2,073,600)	1280 x 960 (1,228,800)
Total pixels of camera sensor	2,073,600	1,320,000
Pixels processed per second (=effective pixels x frames per second)	124,416,000	36,864,000
Color reproduction / precision	very good colors (sRGB color precision)	
Native signal output	1080p HD (1920x1080)	WXGA (1280x800), 720p HD (1280x720)
Converted output signals (4:3 and 5:4)	UXGA (1600x1200), SXGA (1280x1024), XGA (1024x768), SVGA (800x600)	UXGA (1600x1200), SXGA (1280x1024), XGA (1024x768), SVGA (800x600)
Converted Widescreen output signals (16:9 and 16:10)	WUXGA (1920x1200), WXGA (1280x800), 720p (1280x720)	WUXGA (1920x1200), 1080p (1920x1080)
Resolution (measured)	980 lines	860 lines
Brightness control / White balance adjustment	automatic and manual	
Autofocus / Speed	yes (continuously working, high speed)	
Manual focus	yes	
Easy positioning of objects with "Synchronized Lasermarkers"	-	yes (with 6 marks for 16:9 aspect ratio)
Built-in LCD widescreen preview monitor	yes (93x52.7mm / 3.66"x2.07")	
Live to Freeze Comparison (Picture in Picture & Side by Side)	yes	
On screen menu with on screen help	yes	
Firmware Updates via	USB, LAN, USB stick	
Zoom / Lens	64x zoom (16x optical + 4x digital), zoom wheel with multiple speed	
Max object height on working surface	230mm (9") in tele position 370mm (14.6") in wide position	
Max. pick-up area on working surface	16:9 aspect ratio: length: 225mm (8.86"), width: 400mm (15.75") 4:3 aspect ratio: length: 300mm (11.81"), width: 400mm (15.75")	
Min. pick-up area on working surface (in full resolution, with optical zoom)	25x14mm (0.98" x 0.55")	25x19mm (0.98" x 0.75")
Min. pick-up area on working surface (with digital zoom)	6x3.4mm (0.23" x 0.13")	6x4.5mm (0.23" x 0.18")
Max. pick-up area outside of working surface	unlimited	
Depth of focus on small object (42 x 33 mm)	7mm (0.28")	10mm (0.4")
Depth of focus on large object (360 x 270 mm)	200mm (7.9")	260mm (10.2")
Tilt range of camera	290° (110° to speaker + 180° to audience)	
Light source	Maintenance free high-brightness LED light system (high light output, low power consumption), lamp lifetime: 30,000 hours	
vSolution Link Software (USB/LAN), for controlling, image and video capturing and firmware updates	included (for 32- and 64-bit Windows and Macintosh, TwinVIA compatible, with video capture driver)	
UVC Driver for Windows, Linux, and OS X (Mac)	yes	
vSolution Cynap compatible	yes	
Reflection-free area on working surface	whole working surface	
Special working surface for transparencies	yes	
Dry-erase working surface	optional	
Recordings outside of the working surface	yes (to the back and to the front of the unit)	
Automatic image flip	yes (for recordings to the front of the unit)	
Intelligent folding system	articulated arm, 1-step set up	
User programmable presets	3	
User defined settings on USB stick	yes	
Slide pick-up	through integrated slide lightfield	
External computer input / Input switch	yes, 2x HDMI (DVI or DisplayPort via optional adaptor or cable) and WLAN	
Seamless cross-fading between image sources	yes	
WolfVision image processing engine YSOP1	yes	
Image memory	8GB internal memory + additional storage on USB stick or external hard drive	
Browsable image memory (scrollable thumbnails + 1 larger preview image)	yes	
Alternative Image display	negative image / negative-blue image / black and white image	
Connectors	2x HDMI In, 1x HDMI Out, RGB, IP-Addressable LAN Port 10/100 Mbps, USB Device Port, 3x USB Host Ports, Audio Line in, Audio Line out	
Outputs	HDMI (DVI output via optional HDMI-DVI cable or adaptor), RGB	
LAN streaming modes (multicast and unicast)	H.264, Motion JPEG, RTP Motion JPEG, including audio	
WLAN (Dual band stick for 2.4GHz and 5GHz)	Yes (on request, free of charge)	
Onboard video recording including audio	yes (720p HD, up to 30 frames per second, AVI container, H.264 codec, .AVI file extension)	
Audio	yes (built-in microphone, audio Line In / Line Out)	
RS232 port	no (if required external LAN to RS232 adaptors can be used)	
Advanced controlling with professional protocol via LAN and USB	yes	
Dimensions in operation (L x W x H)	408mm x 333mm x 637mm (16.1" x 13.1" x 25.1")	
Dimensions when folded (L x W x H)	408mm x 333mm x 155mm (16.1" x 13.1" x 6.1")	
Weight	5.9kg (13.05lbs)	
Infrared remote control	yes	
Anti-theft device	T-Lock (Kensington® Lock) and table lock bolt	
Power (external power pack)	External desktop power pack: multi range 100-240 V, Max 25.5W, (length of power cord: 1,8 m) Power over Ethernet plus (IEEE 802.3at-2009 standard)	
Carrying case / dust cover	Dust cover included, carrying case optional	
Warranty	5 years	

All units made in Austria, Europe.

Design and specifications subject to change!

Your WolfVision Partner:



More information:



Head Office:

WolfVision GmbH
6833 Klaus / Austria
Tel. +43 5523 52250
wolfvision@wolfvision.com

Japan Sales Office
WolfVision Co. Ltd.
Tel. +81 3 6233 9465
wolfvision.japan@wolfvision.com

USA Sales Office
WolfVision, Inc.
Tel. +1 770 931 6802
sales@wolfvision.us

Middle East Sales Office
WolfVision Middle East (Dubai)
Tel. +971 354 2233
middle.east@wolfvision.net

UK Sales Office
WolfVision UK Ltd.
Tel. +44 1628 509 067
wolfvision.uk@wolfvision.com

Canada Sales Office
WolfVision Canada, Inc.
Tel. +1 613 741 9898
wolfvision.canada@wolfvision.com

Asia Sales Office
WolfVision Pte. Ltd. (Singapore)
Tel. +65 6636 1268
wolfvision.asia@wolfvision.net

Germany Sales Office
WolfVision GmbH
Tel. 0800 9828 787
wolfvision.deutschland@wolfvision.com

