

HD Visual Communication System

Operating Instructions (Version 2.4)

Before operating the unit, please read this manual thoroughly and retain it for future reference.

IPELA



PCS-XL55

Owner's Record

The model and the serial numbers are located at the rear. Record the serial number in the space provided below. Refer to these numbers whenever you call upon your Sony dealer regarding this product.

Model No. _____
Serial No. _____

WARNING

To reduce a risk of fire or electric shock, do not expose this product to rain or moisture.

To avoid electrical shock, do not open the cabinet. Refer servicing to qualified personnel only.

IMPORTANT

The nameplate is located on the rear.

WARNING

Use the AC power adapter provided with this equipment as a power supply source.

Manufacture	Type No.
Sony	VGP-AC19V54

Any other power sources may result in hazards such as a fire.

Disconnect device of this equipment is the mains plug of the AC adapter.

The mains plug on this equipment must be used to disconnect mains power.

Please ensure that the socket outlet is installed near the equipment and shall be easily accessible.

In the event of abnormal operations, disconnect the mains plug.

NOTICE

Use the power cord set approved by the appropriate testing organization for the specific countries where this unit is to be used.

NOTICE

Each of PCS-XL55 and PCS-RF1 contains an RF (Radio Frequency) transmitting and receiving module. Operation is subject to applicable local radio communication regulations in each country.

This equipment should be installed and operated with minimum distance 20cm between the radiator & your body. This transmitter must not be co-located or operating in conjunction with any other antenna or transmitter.

CAUTION for LAN port

For safety reasons, do not connect the LAN port to any network devices that might have excessive voltage.

Installing batteries

Two R06 (size AA) batteries are supplied for Remote Commander.

To avoid risk of explosion, use R06 (size AA) manganese or alkaline batteries.

CAUTION

Danger of explosion if battery is incorrectly replaced. Replace only with the same or equivalent type recommended by the manufacturer. Dispose of used batteries according to the manufacturer's instructions.

For the customers in the USA

WARNING

This device complies with Part 15 of the FCC Rules.

Operation is subject to the following two conditions: (1) This device may not cause harmful interference, and (2) this device must accept any interference received, including interference that may cause undesired operation.

This equipment has been tested and found to comply with the limits for a Class A digital device, pursuant to Part 15 of the FCC Rules. These limits are designed to provide reasonable protection against harmful interference when the equipment is operated in a commercial environment. This equipment generates, uses, and can radiate radio frequency energy and, if not installed and used in accordance with the instruction

manual, may cause harmful interference to radio communications. Operation of this equipment in a residential area is likely to cause harmful interference in which case the user will be required to correct the interference at his own expense.

You are cautioned that any changes or modifications not expressly approved in this manual could void your authority to operate this equipment.

All interface cables used to connect peripherals must be shielded in order to comply with the limits for a digital device pursuant to Subpart B of Part 15 of FCC Rules.

For the customers in the USA

Lamp in this product contains mercury. Disposal of these materials may be regulated due to environmental considerations. For disposal or recycling information, please contact your local authorities or the Telecommunications Industry Association (www.eiae.org).

FCC Radiation Exposure Statement (PCS-XL55/PCS-RF1):

This equipment complies with FCC radiation exposure limits set forth for an uncontrolled environment. This equipment should be installed and operated with minimum distance 20 cm between the radiator & your body. This transmitter must not be co-located or operating in conjunction with any other antenna or transmitter.

This manual focuses on using ISDN lines to conduct a videoconference, but it also covers non-ISDN lines. If you use ISDN lines, consult your Sony dealer for more information.

- The ISDN service may not be available in some areas.

If you dispose the unit, consult your nearest Sony Service Center. The built-in battery must be treated as a chemical waste.

For the customers in Canada

This Class A digital apparatus complies with Canadian ICES-003.

Cet appareil numérique de la classe A est conforme à la norme NMB-003 du Canada.

IC Interference Statement (PCS-XL55/PCS-RF1)

This device complies with RSS-210 of the IC Rules. Operation is subject to the following two conditions:

1. This device may not cause harmful interference, and
2. This device must accept any interference received, including interference that may cause undesired operation.

(PCS-XL55)

The term "IC:" before the radio certification number only signifies that Industry Canada technical specifications were met.

IC:7424A-ZM100

IC Radiation Exposure Statement:

This equipment complies with IC RSS-102 radiation exposure limits set forth for an uncontrolled environment.

This equipment should be installed and operated with minimum distance 20 cm between the radiator & your body.

For the customers in Europe

The manufacturer of this product is Sony Corporation, 1-7-1 Konan, Minato-ku, Tokyo, 108-0075 Japan.

The Authorized Representative for EMC and product safety is Sony Deutschland GmbH, Hedelfinger Strasse 61, 70327 Stuttgart, Germany. For any service or guarantee matters please refer to the addresses given in separate service or guarantee documents.

(PCS-XL55/PCS-RF1)

This equipment conforms to R&TTE Directive 1999/5/EC. For details, please access the following URL:

<http://www.compliance.sony.de>

For the customers in Europe, Australia and New Zealand

WARNING

This is a Class A product. In a domestic environment, this product may cause radio interference in which case the user may be required to take adequate measures.

In the case that interference should occur, consult your nearest authorized Sony service facility.

This apparatus shall not be used in the residential area.

ATTENTION

The electromagnetic fields at the specific frequencies may influence the picture of this unit.

For the customers in Taiwan only



廢電池請回收

For the customers in Europe (PCS-XL55)



Language	Informal DoC
Bulgarian	С настоящето Сони Корпорация декларира, че този PCS-XL55/HD Visual Communication System е в съответствие с основните изисквания и другите съответстващи клаузи на Директива 1999/5/ЕС. Подробности може да намерите на Интернет страницата : http://www.compliance.sony.de
Czech	Sony Corporation tímto prohlašuje, že tento PCS-XL55/HD Visual Communication System je ve shodě se základními požadavky a dalšími příslušnými ustanoveními směrnice 1999/5/ES. Podrobnosti lze získat na následující URL: http://www.compliance.sony.de/
Danish	Undertegnede Sony Corporation erklærer herved, at følgende udstyr PCS-XL55/HD Visual Communication System overholder de væsentlige krav og øvrige relevante krav i direktiv 1999/5/EF. For yderligere information gå ind på følgende hjemmeside: http://www.compliance.sony.de/
Dutch	Hierbij verklaart Sony Corporation dat het toestel PCS-XL55/HD Visual Communication System in overeenstemming is met de essentiële eisen en de andere relevante bepalingen van richtlijn 1999/5/EG. Nadere informatie kunt u vinden op: http://www.compliance.sony.de/
English	Hereby, Sony Corporation, declares that this PCS-XL55/HD Visual Communication System is in compliance with the essential requirements and other relevant provisions of Directive 1999/5/EC. For details, please access the following URL: http://www.compliance.sony.de/
Estonian	Sony Corporation kinnitab käesolevaga seadme PCS-XL55/HD Visual Communication System vastavust 1999/5/EÜ direktiivi põhinõuetele ja nimetatud direktiivist tulenevatele teistele asjakohastele sätetele. Üksikasjalikum info: http://www.compliance.sony.de/

Language	Informal DoC
Finnish	Sony Corporation vakuuttaa täten että PCS-XL55/HD Visual Communication System tyypinen laite on direktiivin 1999/5/EY oleellisten vaatimusten ja sitä koskevien direktiivin muiden ehtojen mukainen. Halutessasi lisätietoja, käy osoitteessa: http://www.compliance.sony.de/
French	Par la présente Sony Corporation déclare que l'appareil PCS-XL55/HD Visual Communication System est conforme aux exigences essentielles et aux autres dispositions pertinentes de la directive 1999/5/CE. Pour toute information complémentaire, veuillez consulter l'URL suivante: http://www.compliance.sony.de/
German	Hiermit erklärt Sony Corporation, dass sich das Gerät PCS-XL55/HD Visual Communication System in Übereinstimmung mit den grundlegenden Anforderungen und den übrigen einschlägigen Bestimmungen der Richtlinie 1999/5/EG befindet. Weitere Informationen erhältlich unter: http://www.compliance.sony.de/
Greek	Με την παρούσα η Sony Corporation δηλώνει ότι PCS-XL55/HD Visual Communication System συμμορφώνεται προς της ουσιώδεις απαιτήσεις και τις λοιπές σχετικές διατάξεις της οδηγίας 1999/5/EK. Για λεπτομέρειες παρακαλούμε όπως ελέγξετε την ακόλουθη σελίδα του διαδ. κττύου: http://www.compliance.sony.de/
Hungarian	Alulírott, Sony Corporation nyilatkozom, hogy a(z) PCS-XL55/HD Visual Communication System megfelel a vonatkozó alapvető követelményeknek és az 1999/5/EC irányelv egyéb előírásainak. További információkat a következő weboldalon találhat: http://www.compliance.sony.de
Italian	Con la presente Sony Corporation dichiara che questo PCS-XL55/ HD Visual Communication System è conforme ai requisiti essenziali ed alle altre disposizioni pertinenti stabilite dalla direttiva 1999/5/CE. Per ulteriori dettagli, si prega di consultare il seguente URL: http://www.compliance.sony.de/
Latvian	Ar šo Sony Corporation deklarē, ka PCS-XL55/HD Visual Communication System atbilst Direktīvas 1999/5/EK būtiskajām prasībām un citiem ar to saistītajiem noteikumiem. Plašāka informācija ir pieejama: http://www.compliance.sony.de/
Lithuanian	Šiuo Sony Corporation deklaruoja, kad šis PCS-XL55/HD Visual Communication System atitinka esminius reikalavimus ir kitas 1999/5/EB Direktyvos nuostatas. Susipažinti su visu atitikties deklaracijos turiniu Jūs galite interneto tinklalapyje: http://www.compliance.sony.de/
Norwegian	Sony Corporation erklærer herved at utstyret PCS-XL55/HD Visual Communication System er i samsvar med de grunnleggende krav og øvrige relevante krav i direktiv 1999/5/EF. For flere detaljer, vennligst se: http://www.compliance.sony.de/
Polish	Niniejszym Sony Corporation oświadcza, że PCS-XL55/HD Visual Communication System jest zgodne z zasadniczymi wymaganiami oraz innymi stosownymi postanowieniami Dyrektywy 1999/5/WE. Szczegółowe informacje znaleźć można pod następującym adresem URL: http://www.compliance.sony.de/

Language	Informal DoC
Portuguese	Sony Corporation declara que este PCS-XL55/HD Visual Communication System está conforme os requisitos essenciais e outras disposições da Directiva 1999/5/CE. Para mais informacoes, por favor consulte a seguinte URL: http://www.compliance.sony.de/
Romanian	Prin prezenta, Sony Corporation declară că acest PCS-XL55/HD Visual Communication System respectă cerințele esențiale și este în conformitate cu prevederile Directivei 1995/5/EC. Pentru detalii, vă rugăm accesați următoarea adresă: http://www.compliance.sony.de/
Slovak	Sony Corporation týmto vyhlasuje, že PCS-XL55/HD Visual Communication System spĺňa základné po žiadavky a všetky príslušné ustanovenia Smernice 1999/5/ES. Podrobnosti získate na nasledovnej webovej adrese: http://www.compliance.sony.de/
Slovenian	Sony Corporation izjavlja, da je ta PCS-XL55/HD Visual Communication System v skladu z bistvenimi zahtevami in ostalimi relevantnimi določili direktive 1999/5/ES. Za podrobnosti vas napro šamo, če pogledate na URL http://www.compliance.sony.de/
Spanish	Por medio de la presente Sony Corporation declara que el PCS-XL55/HD Visual Communication System cumple con los requisitos esenciales y cualesquiera otras disposiciones aplicables o exigibles de la Directiva 1999/5/CE. Para mayor información, por favor consulte el siguiente URL: http://www.compliance.sony.de/
Swedish	Härmed intygar Sony Corporation att denna PCS-XL55/HD Visual Communication System står i ö verensstämmelse med de väsentliga egenskapskrav och övriga relevanta bestämmelser som framgår av direktiv 1999/5/EG. För ytterligare information gå in på följande hemsida: http://www.compliance.sony.de/

For the customers in Europe (PCS-RF1)



Language	Informal DoC
Bulgarian	С настоящето Сони Корпорация декларира, че този PCS-RF1/RF Remote Commander о тговаря на основните изисквания и другите съответстващи клаузи на Директива 1999/5/EC. Подроbnости може да намерите на Интернет страницата : http://www.compliance.sony.de/
Czech	Sony Corporation tímto prohlašuje, že tento PCS-RF1/RF Remote Commander je ve shodě se základními požadavky a dalšími příslušnými ustanoveními směrnice 1999/5/ES. Podrobnosti lze získat na následující URL: http://www.compliance.sony.de/
Danish	Undertegnede Sony Corporation erklærer herved, at følgende udstyr PCS-RF1/RF Remote Commander overholder de væsentlige krav og øvrige relevante krav i direktiv 1999/5/EF. For yderligere information gå ind på følgende hjemmeside: http://www.compliance.sony.de/

Language	Informal DoC
Dutch	Hierbij verklaart Sony Corporation dat het toestel PCS-RF1/RF Remote Commander in overeenstemming is met de essentiële eisen en de andere relevante bepalingen van richtlijn 1999/5/EG. Nadere informatie kunt u vinden op: http://www.compliance.sony.de/
English	Hereby, Sony Corporation, declares that this PCS-RF1/RF Remote Commander is in compliance with the essential requirements and other relevant provisions of Directive 1999/5/EC. For details, please access the following URL: http://www.compliance.sony.de/
Estonian	Sony Corporation kinnitab käesolevaga seadme PCS-RF1/RF Remote Commander vastavust 1999/5/EÜ direktiivi põhinõuetele ja nimetatud direktiivist tulenevatele teistele asjakohastele sätetele. Üksikasjalikum info: http://www.compliance.sony.de/ .
Finnish	Sony Corporation vakuuttaa täten että PCS-RF1/RF Remote Commander tyyppinen laite on direktiivin 1999/5/EY oleellisten vaatimusten ja sitä koskevien direktiivin muiden ehtojen mukainen. Halutessasi lisätietoja, käy osoitteessa: http://www.compliance.sony.de/
French	Par la présente Sony Corporation déclare que l'appareil PCS-RF1/RF Remote Commander est conforme aux exigences essentielles et aux autres dispositions pertinentes de la directive 1999/5/CE. Pour toute information complémentaire, veuillez consulter l'URL suivante: http://www.compliance.sony.de/
German	Hiermit erklärt Sony Corporation, dass sich das Gerät PCS-RF1/RF Remote Commander in Übereinstimmung mit den grundlegenden Anforderungen und den übrigen einschlägigen Bestimmungen der Richtlinie 1999/5/EG befindet. Weitere Informationen erhältlich unter: http://www.compliance.sony.de/
Greek	Με την παρούσα η Sony Corporation δηλώνει ότι PCS-RF1/RF Remote Commander συμμορφώνεται προς της ουσιώδεις απαιτήσεις και τις λοιπές σχετικές διατάξεις της οδηγίας 1999/5/EK. Για λεπτομέρειες παρακαλούμε όπως ελέγξετε την ακόλουθη σελίδα του διαδικτύου: http://www.compliance.sony.de/
Hungarian	Alulírott, Sony Corporation nyilatkozom, hogy a(z) PCS-RF1/RF Remote Commander megfelel a vonatkozó alapvető követelményeknek és az 1999/5/EC irányelv egyéb előírásainak. További információkat a következő weboldalon találhat: http://www.compliance.sony.de/
Italian	Con la presente Sony Corporation dichiara che questo PCS-RF1/RF Remote Commander è conforme ai requisiti essenziali ed alle altre disposizioni pertinenti stabilite dalla direttiva 1999/5/CE. Per ulteriori dettagli, si prega di consultare il seguente URL: http://www.compliance.sony.de/
Latvian	Ar šo Sony Corporation deklarē, ka PCS-RF1/RF Remote Commander atbilst Direktīvas 1999/5/EK būtiskajām prasībām un citiem ar to saistītajiem noteikumiem. Plašāka informācija ir pieejama: http://www.compliance.sony.de/
Lithuanian	Šiuo Sony Corporation deklaruoja, kad šis PCS-RF1/RF Remote Commander atitinka esminius reikalavimus ir kitas 1999/5/EB Direktyvos nuostatas. Susipažinti su visu atitikties deklaracijos turiniu Jūs galite interneto tinklalapyje: http://www.compliance.sony.de/

Language	Informal DoC
Norwegian	Sony Corporation erklærer herved at utstyret PCS-RF1/RF Remote Commander er i samsvar med de grunnleggende krav og øvrige relevante krav i direktiv 1999/5/EF. For flere detaljer, vennligst se: http://www.compliance.sony.de/
Polish	Niniejszym Sony Corporation oświadcza, że PCS-RF1/RF Remote Commander jest zgodne z zasadniczymi wymaganiami oraz innymi stosownymi postanowieniami Dyrektywy 1999/5/WE. Szczegółowe informacje znaleźć można pod następującym adresem URL: http://www.compliance.sony.de/
Portuguese	Sony Corporation declara que este PCS-RF1/RF Remote Commander está conforme os requisitos essenciais e outras disposições da Directiva 1999/5/CE. Para mais informações, por favor consulte a seguinte URL: http://www.compliance.sony.de/
Romanian	Prin prezenta, Sony Corporation declară că acest PCS-RF1/RF Remote Commander respectă cerințele esențiale și este în conformitate cu prevederile Directivei 1995/5/EC. Pentru detalii, vă rugăm accesați următoarea adresă: http://www.compliance.sony.de/
Slovak	Sony Corporation týmto vyhlasuje, že PCS-RF1/RF Remote Commander spĺňa základné požiadavky a všetky príslušné ustanovenia Smernice 1999/5/ES. Podrobnosti získate na nasledovnej webovej adrese: http://www.compliance.sony.de/
Slovenian	Sony Corporation izjavlja, da je ta PCS-RF1/RF Remote Commander v skladu z bistvenimi zahtevami in ostalimi relevantnimi določili direktive 1999/5/ES. Za podrobnosti vas naprošamo, če pogledate na URL: http://www.compliance.sony.de/
Spanish	Por medio de la presente Sony Corporation declara que el PCS-RF1/RF Remote Commander cumple con los requisitos esenciales y cualesquiera otras disposiciones aplicables o exigibles de la Directiva 1999/5/CE. Para mayor información, por favor consulte el siguiente URL: http://www.compliance.sony.de/
Swedish	Härmed intygar Sony Corporation att denna PCS-RF1/RF Remote Commander står i ö verensstämmelse med de väsentliga egenskapskrav och övriga relevanta bestämmelser som framgår av direktiv 1999/5/EG. För ytterligare information gå in på följande hemsida: http://www.compliance.sony.de/

Precautions

Operating or storage location

Avoid operating or storing the system in the following locations:

- Extremely hot or cold places
- Humid or dusty places
- Places exposed to strong vibration
- Close to sources of strong magnetism
- Close to sources of powerful electromagnetic radiation, such as radios or TV transmitters
- Noisy places

LCD screen

Notes on use

- Do not expose the LCD screen surface to the sun. Doing so may damage the screen surface.
- Do not push or scratch the LCD screen, or place objects on top of the system. The image may become uneven or the LCD panel may be damaged.
- If the system is used in a cold place, a smear may occur in the picture or the picture may become dark. This does not indicate a failure. These phenomena improve as the temperature rises.
- Ghosting may occur when still pictures are displayed continuously. It may disappear after a few moments.
- The screen and cabinet get warm when the system is in use. This is not a malfunction.

Display pixels

Although the LCD display panel is made with high-precision technology and has an effective picture element ratio of over 99.99%, black dots (dead pixels) may appear on the screen or pixels may become permanently lit (red, blue, green, etc.) or unlit. The appearance of dead pixels after extended periods of use is common among LCD display panels. Be aware that such appearances do not represent a malfunction.

Phenomena specific to CMOS sensors

The following phenomena that may appear in images are specific to CMOS (Complementary Metal Oxide

Semiconductor) sensors. They do not indicate malfunctions.

White flecks

Although the CMOS sensors are produced with high-precision technologies, fine white flecks may be generated on the screen in rare cases, caused by cosmic rays, etc.

This is related to the principle of CMOS sensors and is not a malfunction.

The white flecks especially tend to be seen in the following cases:

- when operating at a high environmental temperature
- when you have raised the gain (sensitivity)

Aliasing

When fine patterns, stripes, or lines are shot, they may appear jaggged or flicker.

Built-in speakers

The speakers generate magnetism. To avoid damaging the data, keep magnetic tapes and disks away from the speakers.

Cleaning

- Before cleaning, disconnect the power cord from the AC outlet.
- The LCD screen surface is finished with a special coating. To remove dust from the screen surface, wipe gently with a soft, dry cloth.
- Use a soft, dry cloth to gently wipe the cabinet and panel when cleaning the unit. For heavier cleaning, use a cloth lightly moistened with a mild detergent to remove the dust, and finish by wiping again with a dry cloth. Do not use volatile solvents such as alcohol, benzene, thinners, or insecticides as they may damage the surface finishes.

Note on laser beams

Laser beams may damage a CMOS image sensor. You are cautioned that the surface of a CMOS image sensor should not be exposed to laser beam radiation in an environment where a laser beam device is used.

Table of Contents

Chapter 1: Installation and Preparation

Using This Manual	16
Features	17
System Components	19
Basic System Components	19
Optional Equipment	20
System Configuration	21
System Configuration via a LAN	21
System Configuration via an ISDN	22
System Configuration via a SIP	23
System Configuration via a LAN for Multipoint	23
System Configuration via an ISDN for Multipoint	24
System Configuration via a LAN and ISDN for Multipoint	25
System Connections	26
System Connection via a LAN	27
System Connection via an ISDN	28
System Connection via a SIP	29
Preparing the System	30
Inserting Batteries into the Remote Commander	30
Pairing the Remote Commander	31
Turning the System On/Off	33
Opening the Lens Cover	33
Turning On	34
Standby Mode Function	36
Setting the HD Visual Communication System to Standby Mode	36
Turning Off	37
Adjusting the Volume	37
Connecting External Microphones and Headphones	37
Using the System as a Computer Display	37
Setting Up the System Immediately after the Installation —	
Initial Setup Wizard	39
Using the Menus	42
Identifying the Home Menu	42
Operation Using the Menu	49
Entering Characters Using the Remote Commander	51
Entering Characters Using the On-Screen Keyboard	52

Chapter 2: Registration and Setup for System Administrators

Registering Local Information	54
Opening the Setup Menu	54
Line Interface Setup Menu	57
Dial Setup Menu	57
Answer Setup Menu	58
Multipoint Setup Menu	58
Communication Setup Menu	59
Audio Setup Menu	62
Video Setup Menu	65
LAN Setup Menu	66
QoS Setup Menu	69
TOS Setup Menu	70
SIP Setup Menu	71
ISDN Setup Menu	71
SPID Settings for Customers in the USA and Canada	72
Annotation Setup Menu	73
Camera Setup Menu	74
General Setup Menu	74
Home Menu Setup Menu	76
Administrator Setup Menu	77
Encryption Setup Menu	82
Shared Phone Book Setup Menu	82
Displaying the Machine Status	83
Displaying the Machine Status Menu	83
Machine Information	85
Peripheral Status	85
Communication Mode Status	85
LAN Line Status	86
Network Routing Check	86
Restrictions on the Use of IPv6	87
Setting Up the Network Configurations	88
LAN Connection via DHCP	88
LAN Connection through a Router	89
LAN Connection through a Gatekeeper	90
LAN Connection through NAT	91
LAN Connection with H.460 Firewall Traversal	92
LAN Connection Using PPPoE	94
ISDN Connections	95
About the Network Routing Check	96

Chapter 3: Basic Connection

Starting a Connection by Calling a Remote Party	97
Turning On the Power	97
Calling a Remote Party by Using the Connect Menu	99
Calling a Remote Party by Entering Their Address or Number Directly (Direct Dial)	100
Calling a Remote Party Using the One-Touch Dial Buttons	101
Calling a Remote Party by Selecting Them in the History List	102
Calling a Remote Party Registered in the Phone Book	103
Calling a Remote Party Not Registered in the Phone Book	105
Receiving a Call from a Remote Party	109
Answering Calls (Manual/Auto Answer Mode)	109
Answering a Call from a Remote Party	109
Ending the Connection	111
Registering a Remote Party – Phone Book	112
Registering a New Remote Party	112
Editing the Contents of the Phone Book	115
Copying a Registered Party in the Phone Book	116
Deleting the Registered Remote Party	116
Creating a Group in the Phone Book (Group Edit)	116
Creating a Private Phone Book	119
Using the Shared Phone Book	121
Adjusting the Sound	123
Adjusting the Volume of the Received Sound	123
Turning Off the Sound Momentarily – Muting Function	123
Turning Off the Sound on Answering – Mic on Answer Function	124
Synchronizing Audio and Video – Lip Sync Function	124
Reducing Echo – Echo Canceller	124
Adjusting the Camera	125
Adjusting the Camera Zoom	125
Adjusting the Brightness	126
Using the Preset Function	127
Adjusting the Camera in the Detailed Setup Menu	130
Selecting the Input Picture and Sound	132
Switching the Displayed Picture between the Local and Remote Pictures	132
Selecting the Input Picture	132
Selecting the Video Input Using the F1 to F4 (Function) Buttons on the Remote Commander	133
Switching the Sound to Be Sent to the Remote Party	133
Switching Video and Audio at the Same Time	133
Switching the Picture from the Remote System	134
Switching the Picture Displayed on the Monitor Screen	135

Capturing the Screen	137
----------------------------	-----

Chapter 4: Connection with Optional Equipment

Using a Tools Menu	139
Using the Computer Picture for Presentation	141
Installing the HD Data Solution Software	141
Connecting a Computer	142
Making a Presentation	142
Streaming a Communication	144
Recording a Visual Communication	146
Using the Annotation Function	148
Connecting a Pen Tablet	148
Using the Annotation Function while in Communication	149
Using External Microphones and Headphones	153
Recording during a Communication	157
Sending Audio/Video from the External Equipment to a Remote Party	158
Viewing the Picture from the System on a Monitor or Projector	160
Communicating without the Picture – Voice Meeting	162
Controlling the Remote System with the Tone Signal – DTMF Transmission ...	163
Accessing the Communication System	164
Using a Web Browser	164
Using Telnet	164
Using SSH	164

Chapter 5: Encrypted Connection

Preparing for an Encrypted Connection via LAN	166
Starting an Encrypted Connection	168

Chapter 6: Multipoint Connection

Connection Examples of a Multipoint Connection	171
Using the LAN Connection (Up to 3 Points)	171
Using the ISDN Connection	172
Using Both LAN and ISDN	173
Configuring Multipoint	174
Setting Up Multipoint	174
Registering the Remote Parties in the Multipoint Connection List	174
Starting a Multipoint Connection	178
Calling Remote Parties	178

Receiving a Call from a Remote Party	182
Using the Display Control	183
Broadcast Mode	183
Broadcast Modes and Displayed Windows	185
Switching the Broadcast Mode	186
Receiving the Broadcast Requested From Another Terminal	187
Ending the Multipoint Connection	188
Notes on Secondary Terminals	189
Multipoint Attributes	190

Chapter 7: Computer Display Function

Computer Display Function	193
Connecting the Computer	193
Displaying the Computer Picture	193
Outputting the Computer Audio	194
Switching between Videoconference and Computer Pictures	195
Two-Picture Display	195
Automatic Switching from the Computer Picture	195
Starting a Videoconference during Computer Display	196
Calling a Remote Party during Computer Display	196
Receiving a Call during Computer or Two-Picture Display	196
Adjusting the Picture Quality of the Display	197
Picture menu	198
Screen menu	198
Setup menu	199
Information menu	200

Chapter 8: Web Control Function

Opening the Web Page	202
Identifying a User	203
Selecting a Menu	205
How to Use [Home] Menu	206
How to Use [Download] Menu	207
How to Use [Remote Commander] Menu	208
Selecting a Tool	209
How To Configure KIOSK Mode	210
How to Use [Version Up] Page	211
How to Use [Streaming] Page	212
How to Use [Monitor] Page	213

Appendix

Location and Function of Parts and Controls	214
PCS-XL55 HD Visual Communication System	214
PCS-RF1 RF Remote Commander (Supplied)	216
PCSA-B384S ISDN Unit (Optional)	217
PCSA-B768S ISDN Unit (Optional)	218
Indicators	219
On-Screen Messages	222
Troubleshooting	224
Specifications	227
PCS-XL55 HD Visual Communication System	227
PCS-RF1 Remote Commander (Supplied)	228
VGP-AC19V54 AC Adaptor	228
PCS-A1 Microphone (Optional)	228
PCSA-A3 Microphone (Optional)	228
PCSA-B384S ISDN Unit (Optional)	229
PCSA-B768S ISDN Unit (Optional)	229
PCSA-DSG80 HD Data Solution Software (Optional)	229
Acceptable RGB Input/Output Signals	231
Pin Assignments	233
Pin Assignments on Optional Board Connectors	234
Screen Size during Two-Picture Display	235
Display Switching Controls	236
Layout Controls during Videoconference Display	236
Layout Controls between Videoconference and Computer Picture Displays	239
Layout Control Examples	239
List of Port Numbers Used on the PCS-XL55	241
Videoconferencing Room Layout	242
“Memory Stick” Media	243
Phenomena Specific to CMOS Image Sensors	244
Glossary	245
Menu Configuration	248

Chapter 1: Installation and Preparation

Using This Manual

The chapters cover the following contents; please read the chapters that may be required for your type of communication.

Chapter 1: Installation and Preparation

This chapter guides you through the system configuration and information required to use your HD Visual Communication System for the first time. It shows you how to install and connect your Communication System, to turn the system on/off and how to access basic on-screen menus.

Chapter 2: Registration and Setup for System Administrators

This chapter describes how to register and set up all the necessary items for system administrators, using the on-screen menus.

Chapter 3: Basic Connection

This chapter guides you through the basic operations and settings for connecting to a remote party. You will learn how to start connection to finish it. It is recommended that this chapter be read by participants in a communication.

Chapter 4: Connection with Optional Equipment

This chapter shows advanced communication using the optional equipment, and functions such as streaming, recording, presentation and annotation.

Chapter 5: Encrypted Connection

This chapter shows how to connect to a remote party using an encrypted video and

audio data, and encrypted data from a computer.

Chapter 6: Multipoint Connection

This chapter shows you how to connect your system to multiple sites.

Chapter 7: Computer Display Function

This chapter describes how to use the system as a computer display.

Chapter 8: Web Control Function

This chapter shows you how to control the Visual Communication System or set it up via a Web browser.

Appendix

The appendix contains descriptions of the controls and connectors on the components of the HD Visual Communication System, troubleshooting list, specifications, and a glossary.

Features

The PCS-XL55 HD Visual Communication System is a communication system that provides face-to-face communications with a remote party by transmitting and receiving images and sound via LAN (Local Area Network) or ISDN (Integrated Services Digital Network) connections.

Portable integrated HD Visual Communication System

This Communication System integrates a 21.6-inch wide-format display, a camera equipped with digital zoom, a codec, a microphone, and speakers into a portable all-in-one visual communication system.

Supports ITU-T international standard

The Communication System complies with ITU-T Recommendations defined by WTSC for easy connection with remote parties overseas.

ITU: International Telecommunication Union

WTSC: World Telecommunications Standardization Committee

Transmission and reception of high-definition images enabled

The Communication System supports the H.264 Baseline Profile and High Profile high-definition video compression format, enabling transmission and reception of interlaced video signals with a high resolution of 1920 × 1080 or 1280 × 720 by a maximum of 60 frames per second.

Transmission and reception of wide range of stereo sound capability

The audio compression format of the Communication System supports MPEG4 AAC (Advanced Audio Coding) stereo sound and 22 kHz monaural sound, allowing high-quality audio transmission and

reception. The built-in echo canceller supports up to 16 kHz.

Supports data communication

Installing the optional PCSA-DSG80 HD Data Solution Software into the Communication System enables transmission of output data from a computer.

High transmission speeds and high-quality picture capability

The Communication System accepts a LAN communication bit rate of up to 4 Mbps. It also allows you to connect to as many as three ISDN lines and use 6B channels with the optional PCSA-B384S ISDN Unit, and as many as six ISDN lines and use 12B channels with the optional PCSA-B768S ISDN Unit.

Wide range of video/audio compression format selectable

The Communication System supports the H.264, H.263+, H.261 and MPEG4* video compression formats. It also supports the MPEG4 AAC**, G.722, G.728, and G.711 audio compression formats.

* Supports MPEG4 only for connection using SIP.

** Supports MPEG4 AAC only for IP and ISDN connection.

Annotation capability

The annotation function allows you to write letters or graphics on the screen or point with a pointer during communication using the optional pen tablet.

RF (Radio Frequency) Remote Commander adopted

The supplied Remote Commander controls the Communication System using the radio frequency of 2.4 GHz. The Remote Commander can be paired with the System to prevent interference from other Systems and Camera Units.

On-screen keyboard

The on-screen keyboard displayed on the monitor screen allows you to input a number, address, etc. without moving your eyes away from the screen.

QoS (Quality of Service) function for optimization of bandwidth and traffic packet through network

The Communication System includes the “Packet Resend Request”, “Adaptive Rate Control”, and “Forward Error Correction” functions. Depending on the network status, these functions are used in Hybrid to guarantee consistent, high-quality communications.

Compact size

The compact size of the Communication System allows versatile installation layout.

Equipped with a Memory Stick slot

The Communication System is equipped with a Memory Stick slot, allowing you to save still images, create the Private Phone Book and store the customized settings in a “Memory Stick”.

Video and audio recording

Video and audio can be recorded in a “Memory Stick” and can be watched on a computer after.

Streaming

You can broadcast streaming video and audio. This allows people who cannot attend the communication to watch the proceedings over the Web using a computer. You can also select whether to broadcast both video and audio or audio only.

Supports a connection using SIP

The Communication System allows connection to a remote party with an IP phone, etc. using SIP (Session Initiation Protocol).

Supports encrypted connection

The system allows you to make a strictly confidential connection using standard encryption, which complies with the H.233, H.234 and H.235 standardized by the ITU-T.

Supports multipoint connection

The Communication System allows connection among multiple points via a LAN and/or ISDN line.

Computer display functionality

The monitor of the Communication System can be used as a computer display. When you are using the system as a computer display, the display will automatically change and inform you when a call is received from a remote site.

Supports KIOSK mode

You can simplify operations and make calling with one-touch dial the only available operation.

System Components

The PCS-XL55 HD Visual Communication System is composed of basic system components for a basic communication, and optional equipment for an enhanced communication.

Basic System Components

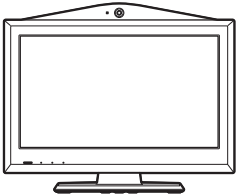
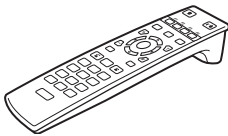
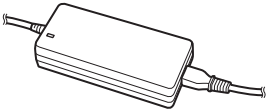

Components packaged in the PCS-XL55

Unit	Description
<p>PCS-XL55 HD Visual Communication System</p> 	Contains the camera, monitor, video codec, audio codec, echo canceller, network interfaces and system controller.
<p>PCS-RF1 Remote Commander</p> 	Used to control the HD Visual Communication System. Before using, pairing with the Communication System is required.
<p>VGP-AC19V54 AC adaptor</p> 	Supplies power to the Communication System.

Optional Equipment

Optional equipment especially designed for use with the Communication System

The following optional devices are used to enhance your videoconference.

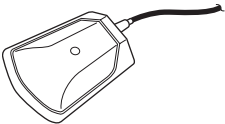
Unit	Description
PCSA-B384S ISDN Unit 	Used to connect to an ISDN line. Up to three ISDN lines; 6B channels usable.
PCSA-B768S ISDN Unit 	Used to connect to an ISDN line. Up to six ISDN lines; 12B channels usable.
PCS-A1 Microphone 	Omni-directional microphone that picks up sound relatively from all directions, allowing participants to speak from any location. It is recommended to use in a quiet situation.
PCSA-A3 Microphone 	Unidirectional microphone. It is recommended when you want to pick up the voice of a speaker directed toward the microphone.
PCSA-DSG80 HD Data Solution Software	Software required for transmission of video and computer pictures at the same time by connecting a computer.

System Configuration

The PCS-XL55 HD Visual Communication System has various system configuration capabilities using the basic components and optional equipment. This section describes the capabilities and necessary equipment for some typical configuration examples.

System Configuration via a LAN

This allows you to:

- Have a point-to-point HD visual communication over LAN.
- Pick up sound in stereo by using two microphones connected to the system.

System configuration

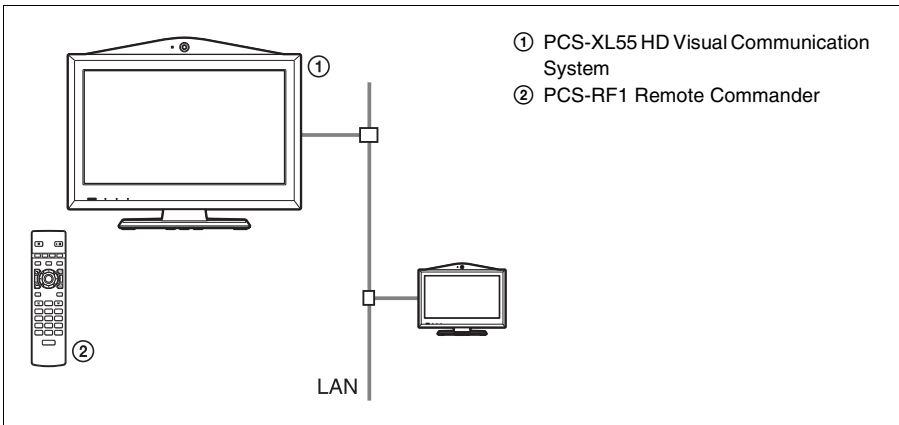

System Configuration via an ISDN

Connection to ISDN is required to use the PCSA-B384S or PCSA-B768S ISDN Unit especially designed for use with this system.

This allows you to:

- Have a point-to-point HD visual communication over ISDN.
- Pick up sound in stereo by using two microphones connected to the system.
- Hold an HD visual communication with high speeds and highest quality image transmission by connecting up to three ISDN lines (when using the PCSA-B384S) or by connecting up to six ISDN lines (when using the PCSA-B768S).

System configuration

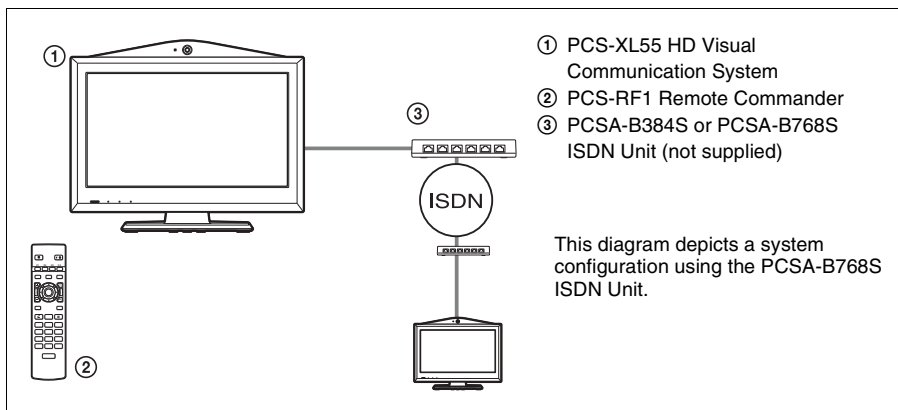

About the number of ISDN lines and B (bearer) channels

Up to three ISDN lines (6B channels) with the PCSA-B384S ISDN Unit or up to six ISDN lines (12B channels) with the PCSA-B768S ISDN Unit can be connected to one Communication System. The more channels you use for a single communication, the faster speeds and higher-quality picture you can obtain for your network communication.

Note

When connecting to the ISDN Unit, Use the ports in ascending order.

Yes: 1, 2, 3...

No: 1, 6, 5...

System Configuration via a SIP

This allows you to:

- Have an HD visual communication with an IP telephone, etc. using SIP.
- Pick up sound in stereo by using two microphones connected to the system.

System configuration

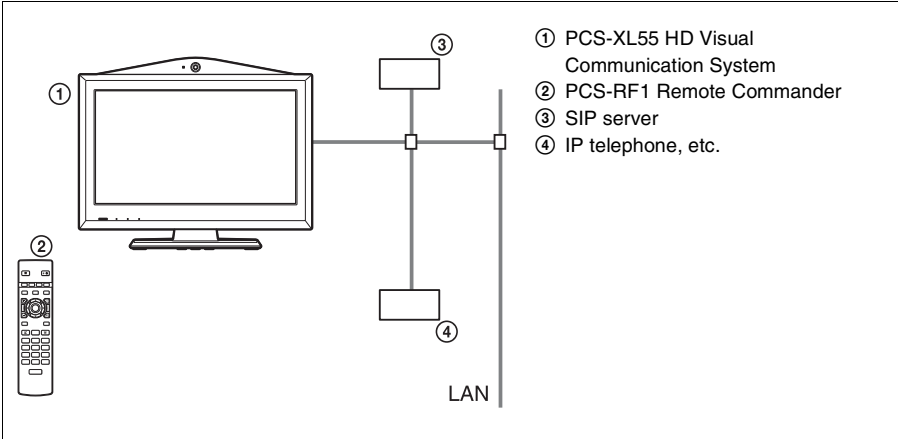

System Configuration via a LAN for Multipoint

This allows you to:

Have a multipoint HD visual communication among up to 3 sites over LAN.

System configuration

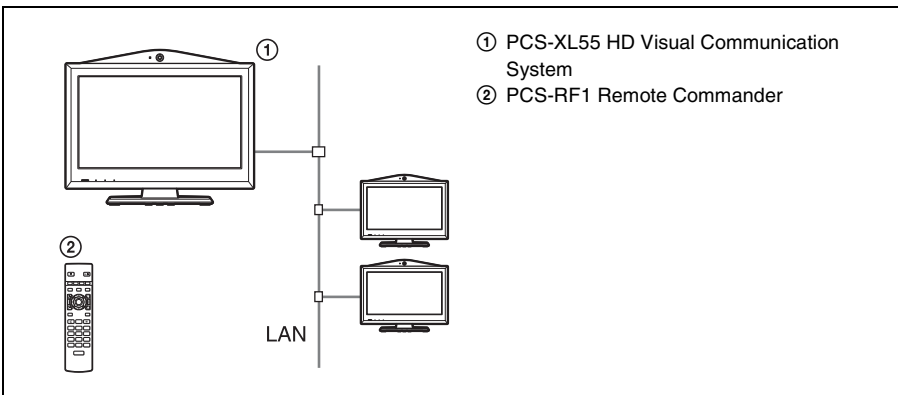

System Configuration via an ISDN for Multipoint

To enable ISDN connection, you need to connect the optional PCSA-B384S or PCSA-B768S ISDN Unit especially designed for use with this system.

This allows you to:

Have a multipoint HD visual communication among up to 3 sites over ISDN.

System configuration

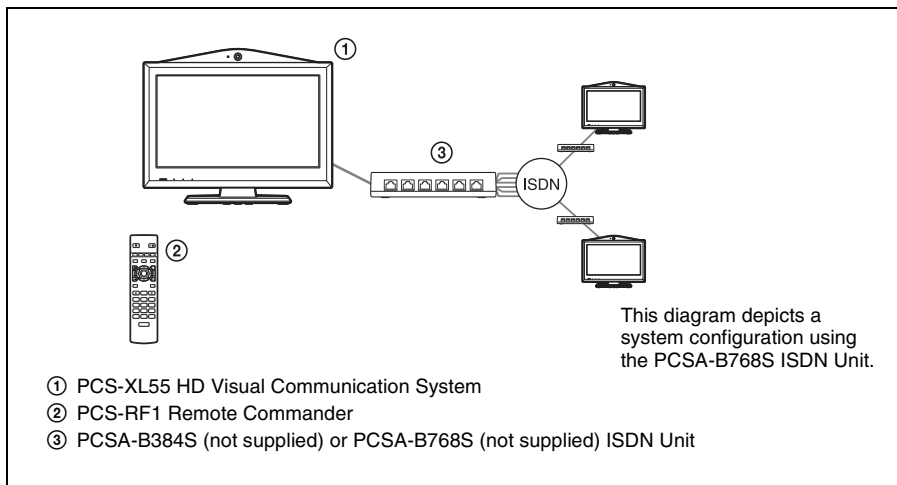

System Configuration via a LAN and ISDN for Multipoint

You can connect to up to 3 sites via mixed LAN and ISDN lines.

This allows you to:

Have a multipoint HD visual communication among up to 3 sites over LAN and ISDN.

System configuration

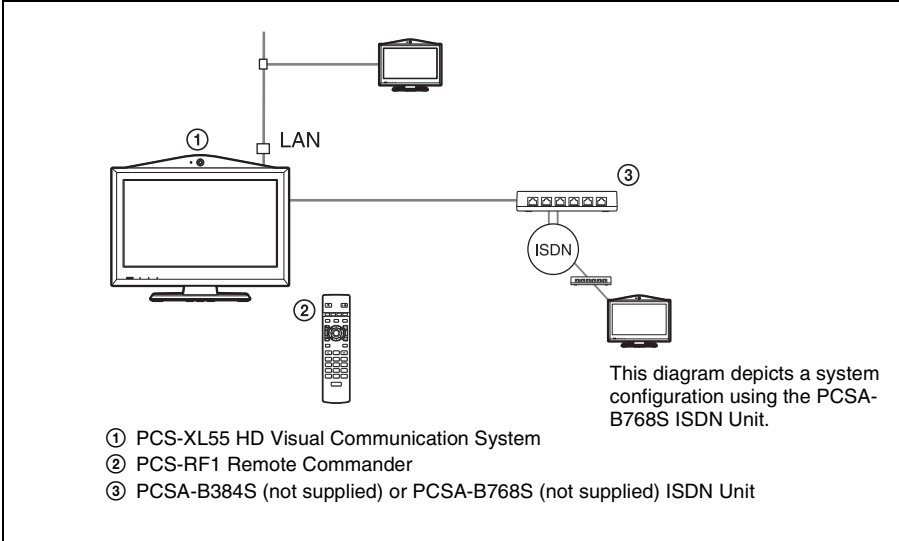

System Connections

This section describes the typical system connections.

Notes

- Be sure to turn off all the equipment before making any connections.
- Do not connect/disconnect the interface cable or pen tablet with the power on. Doing so may damage the Communication System or ISDN Unit.
- For safety, do not connect the 100BASE-TX/10BASE-T connector to a network that applies excess voltage via the 100BASE-TX/10BASE-T connector.
- **When used with the ISDN Unit for the first time**, the Communication System may automatically upgrade the software of the connected equipment. Upgrade the software according to the message displayed on the monitor screen. Be sure not to turn off the Communication System or disconnect the cable during upgrading. Otherwise, it may cause a malfunction of the system.

System Connection via a LAN

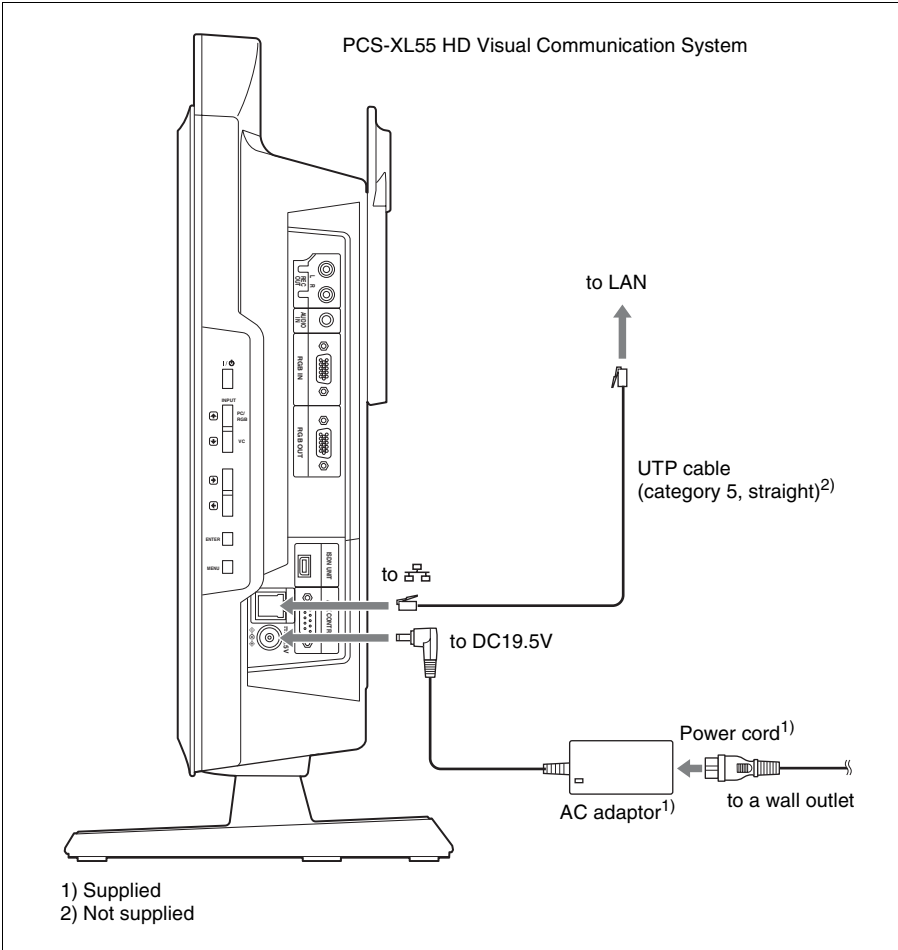

Note

The REC OUT jack is used to make an audio recording of a communication. This is not used during regular communication.

System Connection via an ISDN

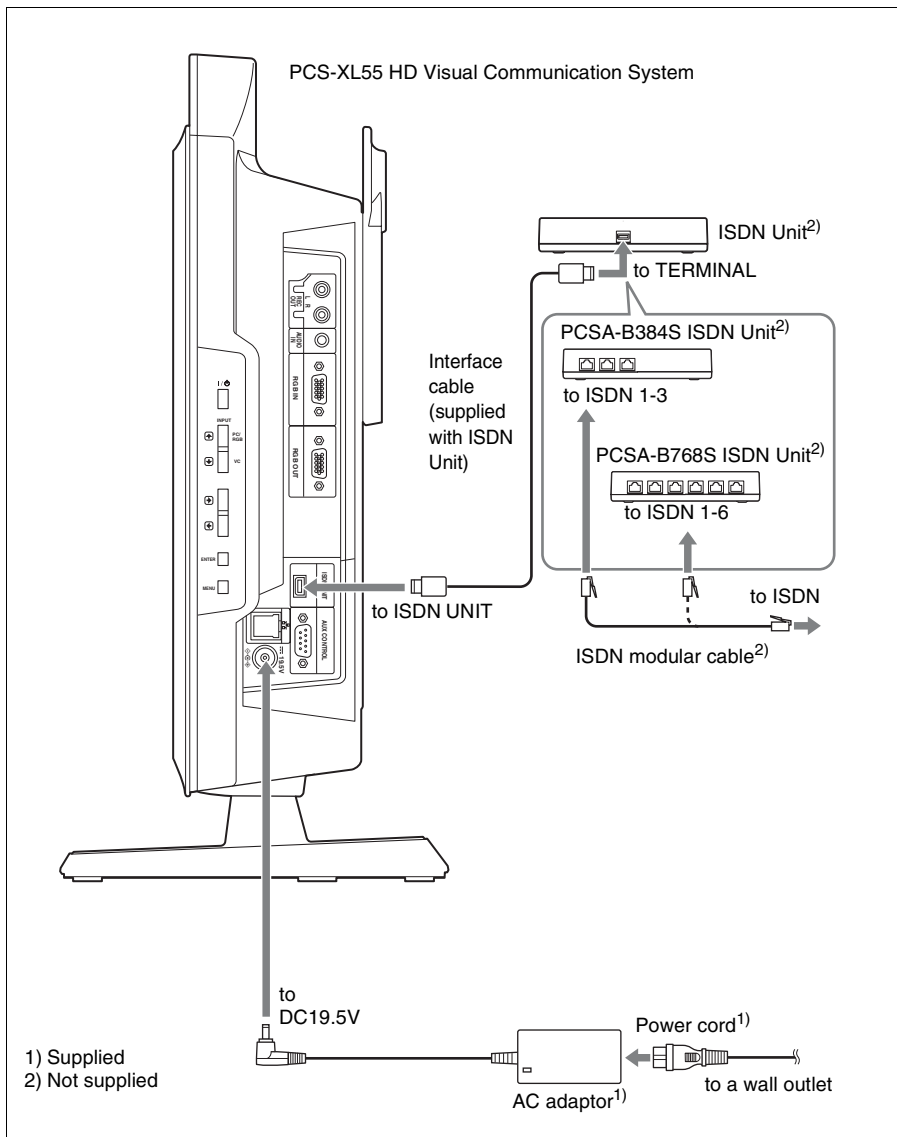

Note

The REC OUT jack is used to make an audio recording of a communication. This is not used during regular conferences.

System Connection via a SIP

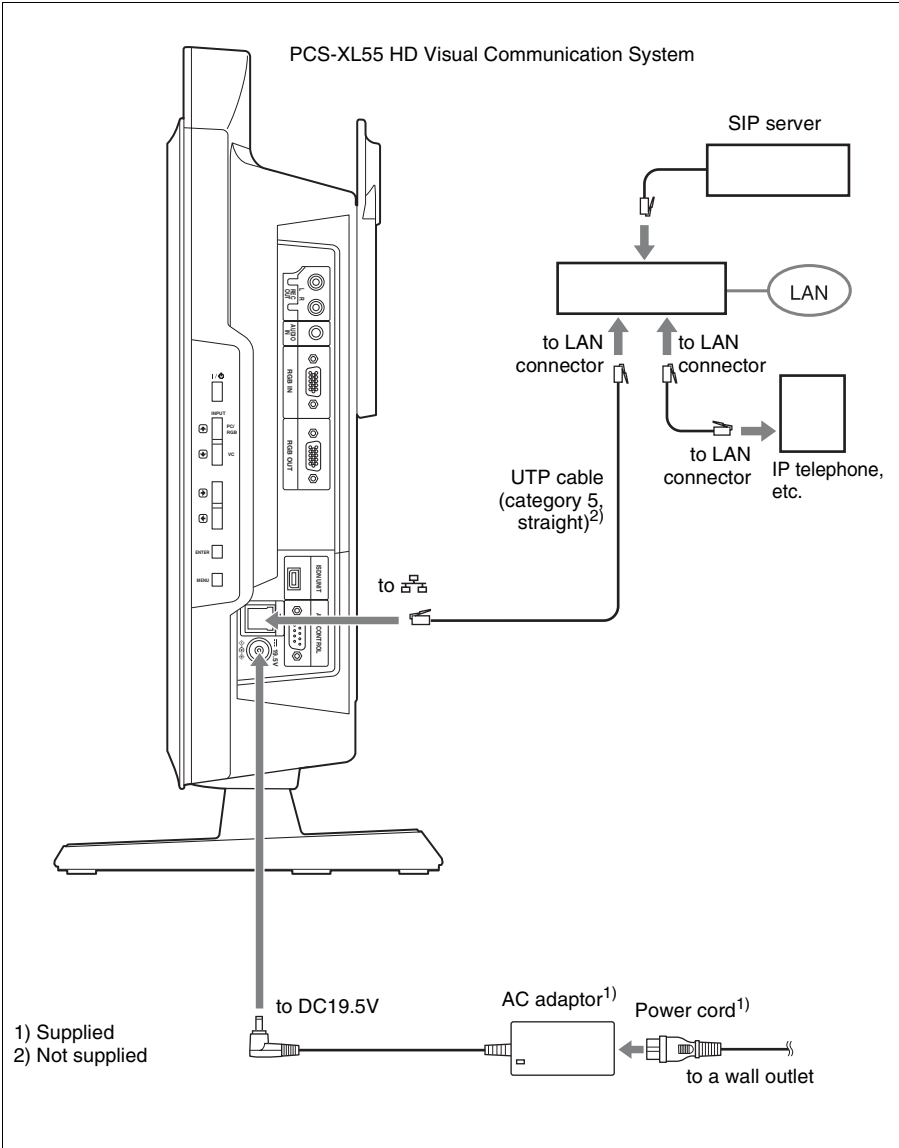

Note

The REC OUT jack is used to make an audio recording of a communication. This is not used during regular communication.

Preparing the System

Inserting Batteries into the Remote Commander

Most of the operations with the HD Visual Communication System can be controlled with the supplied Remote Commander.

- 1 Remove the battery compartment cover.

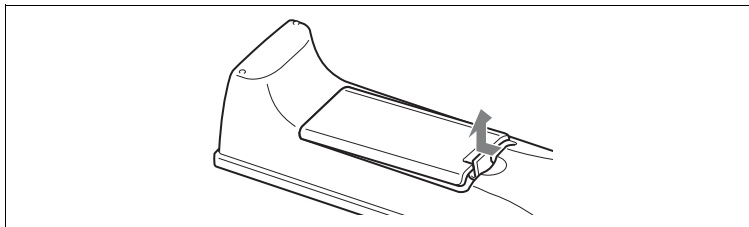

- 2 Insert two size AA (R6) batteries (supplied) with correct polarities into the battery compartment.

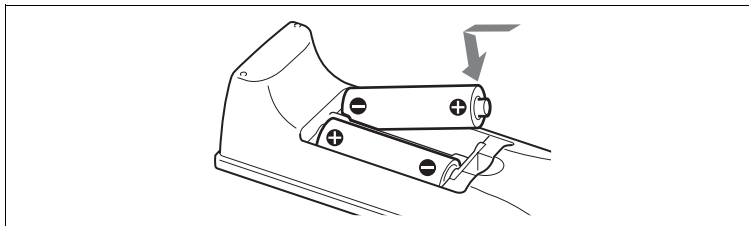

- 3 Replace the cover.

Note

Be sure to insert the batteries **-** side first. Inserting them forcibly **+** side first may damage the insulated film covering the batteries and cause a short circuit.

Battery life

When the batteries are exhausted, the LED indicator does not light if you press any button and the Remote Commander does not function properly. Replace both batteries with new ones.

Notes on batteries

To avoid damage from possible battery leakage or corrosion, observe the following:

- Make sure to insert the batteries with the polarities in the correct direction.
- Do not mix old and new batteries, or different types of batteries.
- Do not attempt to charge the batteries.
- If you do not intend to use the Remote Commander for a long period of time, remove the batteries.

- If battery leakage occurs, clean the battery compartment and replace all the batteries with new ones.

Pairing the Remote Commander

The supplied Remote Commander controls the HD Visual Communication System using the radio frequency of 2.4 GHz. The Remote Commander and the Communication System are paired to prevent interference from other Remote Commanders and Systems.

Pairing between the Remote Commander and the Communication System is programmed at the factory.

Note

When performing the pairing procedure, be sure to turn off other HD Visual Communication Systems located nearby that are not targets for pairing. If multiple devices are turned on, the Remote Commander might pair device other than the target one.

To pair the Communication System with the Remote Commander again

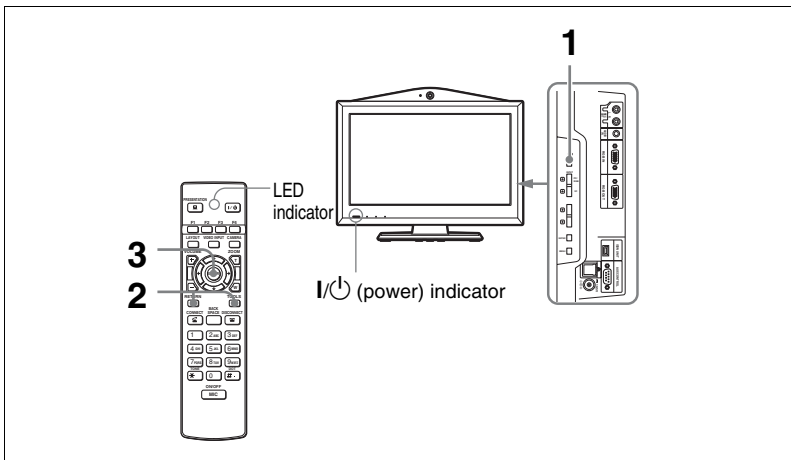

- 1 Press the I/⏻ (power) switch on the Communication System to turn it on. The I/⏻ (power) indicator on the Communication System flashes. “Starting” appears on the bottom right of the monitor, and then the IPELA logo appears.

When the system has finished starting up, the indicator remains steadily lit in green.

- 2** Within three minutes after the power is on, locate the Remote Commander closer to the Communication System, and press the RETURN and TOOLS buttons at the same time.

The LED indicator flashes rapidly.

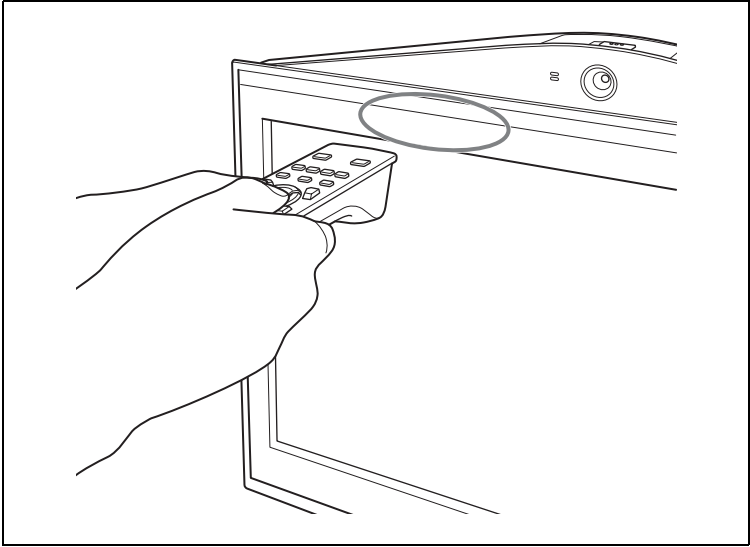

- 3** Press the ENTER button on the Remote Commander.

If the LED indicator flashes more slowly, pairing between the units has succeeded.

When pairing has failed

The LED indicator on the Remote Commander continues flashing rapidly. In this case, press the ENTER button on the Remote Commander again.

To cancel pairing

Press the I/⏻ (power) switch on the Communication System.

Notes

- When the LED indicator does not flash even if you press any button on the Remote Commander, the batteries might be exhausted. Replace both batteries with new ones.
- Once pairing is established between the units, it will not be erased even if the batteries are replaced.
- Operable distance is 10 m (32.8 ft.). Depending on the circumstances, a longer operable distance may be possible.

Turning the System On/Off

This section describes how to turn on or off the Communication System.

Opening the Lens Cover

The system is equipped with a lens cover to hide the camera. Before starting a videoconference, open the lens cover by sliding the lever for lens cover on the top of the system to the right. If the lens cover is closed, the picture on the local site will not be seen on the remote site.

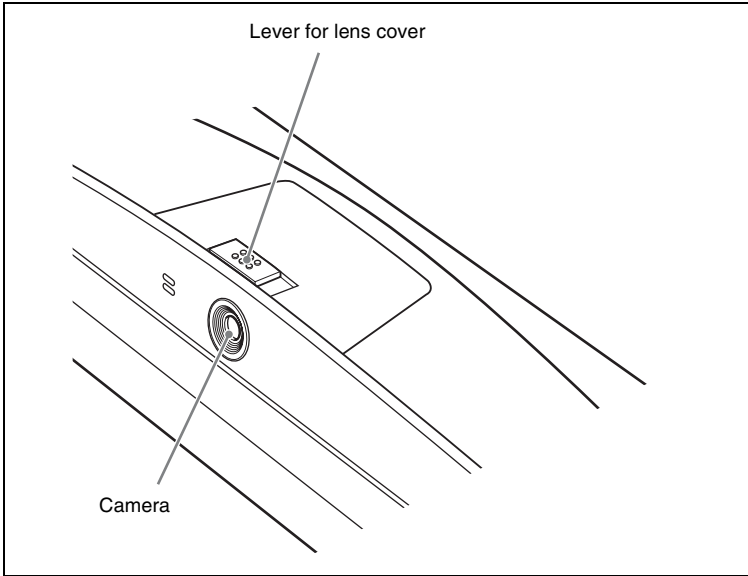

Turning On

- 1 Turn on any external equipment that will be used.
- 2 Press the I/⏻ (power) switch on the Communication System to turn it on.

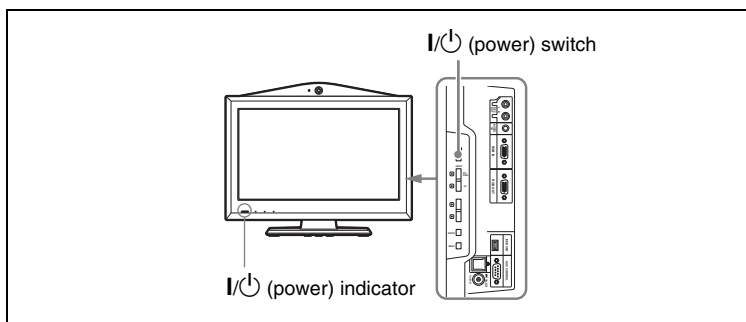

The I/⏻ (power) indicator on the Communication System flashes. “Starting” appears on the bottom right of the monitor, and then the IPELA logo appears.

When the system has finished starting up, the indicator remains steadily lit in green.

The Home menu will appear on the monitor screen and the picture shot by the local camera will also appear in the Home menu.

Home menu

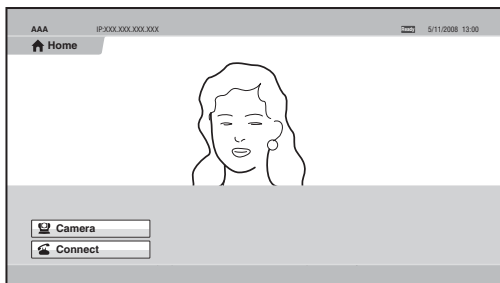

When the lens cover is closed, the Home menu appears as follows.

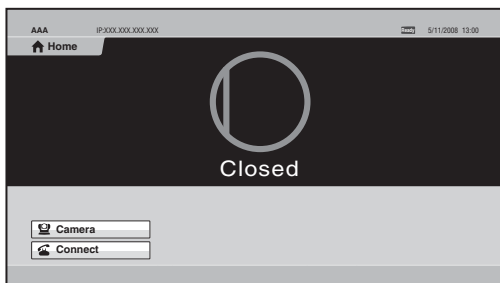

When the camera is turned off, the Home menu appears as follows.



Notes

- If a conference is conducted with the lens cover closed, only a black screen will be visible to the remote party.
- If no communication exists and Remote Commander operations are not performed for 10 minutes, the camera will be turned off automatically.
- If Remote Commander operations are performed while the camera is turned off, the camera will turn on.

For details on the Home menu, see “Identifying the Home Menu” on page 42.

Notes

- When you turn on the power of the Communication System for the first time after installation, the setup wizard will appear after the self-diagnosis is completed. Set up your system following the wizard.

For setups using the wizard, see “Setting Up the System Immediately after the Installation — Initial Setup Wizard” on page 39.

- When used with an optional device especially designed for use with this system, such as the ISDN Unit, for the first time, the Communication System may automatically upgrade the software of the connected device. Upgrade the software according to the message displayed on the monitor screen. Be sure not to turn off the Communication System or disconnect the cable during upgrading. Otherwise, it may cause a malfunction of the system. System malfunction may also occur when a system power-off has been caused by an accidental problem such as a power interruption during upgrading. If connection of the ISDN Unit or other devices to the Communication System is not re-established even after the system power is recovered, consult a Sony dealer.
- You can check the versions of the Communication System, optional dedicated equipment connected and the application software installed using the Machine Status menu.

For details on the Machine Status menu, see page 83.

Standby Mode Function

To save power, the Communication System will enter standby mode if you do not operate it for a specified period of time. When the Communication System is in standby mode, the I/⏻ indicator lights in orange.

You can turn on the Communication System with any button on the Remote Commander if the System is in standby mode.

Once the Communication System receives a call, the standby mode is automatically released.

Setting the HD Visual Communication System to Standby Mode

- 1 Display the Home menu on the monitor screen, then press the I/⏻ button on the Remote Commander.

The message “Power off?” appears on the monitor screen.

- 2 Press the ↑, ↓, ← or → button on the Remote Commander to select OK, then press the ENTER button.

You may press the I/⏻ button on the Remote Commander.

The Communication System enters standby mode and the I/⏻ indicator on the Communication System lights in orange.

To cancel setting the system to standby

Select “Cancel” with the ↑, ↓, ← or → button on the Remote Commander, then press the ENTER button in step 2 above.

To release the standby mode

Press any button on the Remote Commander.

To specify the standby time

Specify the time that you want the system to remain on before entering into standby mode (1 to 99 minutes) by setting “Standby Time” of the Device Setup page of the General setup menu. If you do not want the system to enter the standby mode, set “Standby Mode” to “Off”.

For the settings, see “Standby Time” and “Standby Mode” in the General setup menu on page 74.

Turning Off

- 1 Press the **I/⏻** (power) switch on the Communication System.
The message “Power off?” appears on the monitor screen.
- 2 Press the **↑, ↓, ←** or **→** button on the Remote Commander to select “Power off”, and press the ENTER button.
You can power off the system by pressing the **I/⏻** (power) button on the Remote Commander.
The system turns off.
- 3 Turn off the power of other equipment used for the communication.

Notes

- Turn off the power switch on the Communication System when the system will not be used for an extended period. While the power switch is off, you cannot receive a call from a remote party.
- Be sure to unplug the power cord after the power of the system is turned off completely.
- If the system is unplugged for about 10 days or longer, the clock setting of the system may be reset. In this case, re-set the date and time in the Clock Set page of the General setup menu.

Adjusting the Volume

- 1 Press the VOLUME +/- buttons on the Remote Commander to set the volume to a level where the remote party can be clearly heard.



Connecting External Microphones and Headphones

You can connect an external microphone and headphones for use with the Communication System.

For details on using external microphones and headphones, see “Using External Microphones and Headphones” on page 153.

Using the System as a Computer Display

When connected to a computer, the Communication System can be used as a computer display.

Connect the computer to the RGB IN connector, and press the PC/RGB button on the right side of the system to enable use as a computer display.

You can also press the PC/RGB button and VC button to switch between videoconference display, two-picture display with the videoconference picture as the main picture, and two-picture display with the computer picture as the main picture.

For details on using the system as a computer display, see “Chapter 7: Computer Display Function”.

Setting Up the System Immediately after the Installation — Initial Setup Wizard

When you turn on the Communication System for the first time after installation and the self-diagnosis is completed, the setup wizard appears on the monitor screen. Register your local system data with the setup wizard using the Remote Commander.

Notes

- You can change the settings made with the setup wizard later using the setup menus.
- The setup wizard will also be displayed when you install the PCSA-B384S or PCSA-B768S ISDN Unit to your system later. Perform the setup again.

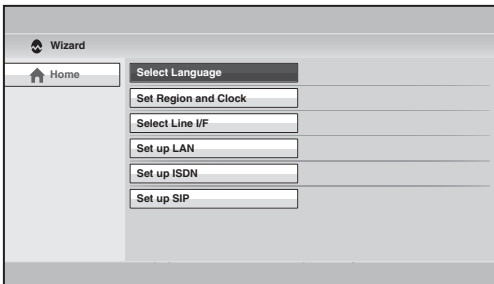

To select the on-screen language

- 1 Use the **↑**, **↓**, **←** or **→** button on the Remote Commander to select “Select Language” in the setup wizard, then press the ENTER button.

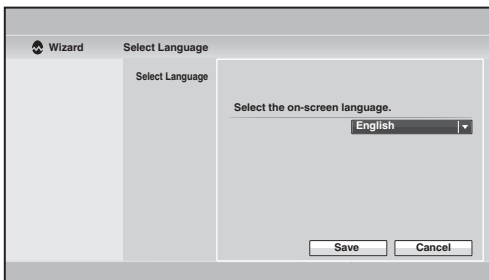

- 2 Use the **↑**, **↓**, **←** or **→** button on the Remote Commander to select the language to be used for the on-screen menus and messages.
Select from among English, French, German, Japanese, Spanish, Italian, Simplified Chinese, Portuguese, Traditional Chinese, Korean, Dutch, Danish, Swedish, Finnish, Polish, Russian, Arabic, Thai, Turkish, Norwegian, Welsh, Czech and Hungarian.

Note

Menu displays may be in English for some languages.

- 3 Use the **↑**, **↓**, **←** or **→** button on the Remote Commander to select “Save”, then press the ENTER button.
The setup wizard is restored.

To set the region and clock

- 1 Use the **↑**, **↓**, **←** or **→** button on the Remote Commander to select “Set Region and Clock” in the setup wizard, then press the ENTER button.
- 2 Set the region and clock items.

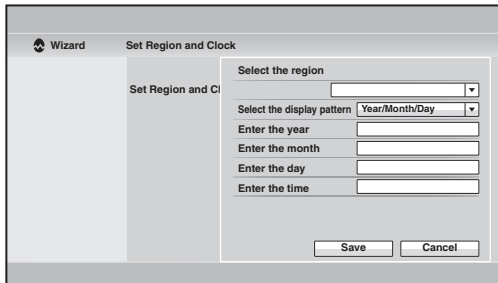

Select the region: Select the country or region where the system is used.

Select the display pattern: Select the display pattern of year, month and day.

Enter the year, Enter the month, Enter the day, Enter the time: Enter the date and time using the number buttons on the Remote Commander.

For the procedure to enter the numbers using the Remote Commander, see “Entering Characters Using the Remote Commander” on page 51.

- 3 Use the **↑**, **↓**, **←** or **→** button on the Remote Commander to select “Save”, then press the ENTER button.
The setup wizard is restored.

To select the line interface

- 1 Use the **↑**, **↓**, **←** or **→** button on the Remote Commander to select “Select Line I/F” in the setup wizard, then press the ENTER button.
- 2 Select the line interface to be used.

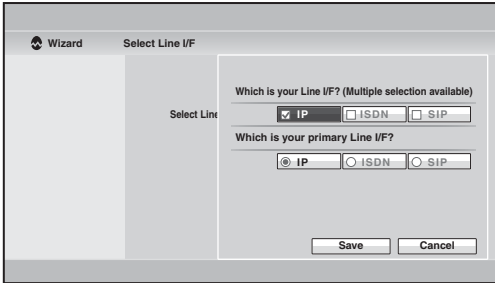

Which is your Line I/F?: Select from among IP, ISDN and SIP.

Which is your primary Line I/F?: If you select two or more interfaces with “Which is your Line I/F?”, select the interface you most use. Select from among IP, ISDN and SIP.

- 3 Use the **↑**, **↓**, **←** or **→** button on the Remote Commander to select “Save”, then press the ENTER button.
The setup wizard appears.

To set up a LAN connection

Select “Set up LAN” in the setup wizard, then set up a LAN connection.

To set up an ISDN line

Select “Set up ISDN” in the setup wizard, then set up an ISDN line connection.

To set up a SIP

Select “Set up SIP” in the setup wizard, then set up a SIP connection.

Using the Menus

The HD Visual Communication System uses the on-screen menus to make various adjustments and settings. This section explains how to adjust or set the items in the menus and gives a brief introduction to the menus.

Identifying the Home Menu

The Home menu is displayed on the monitor screen when the system is turned on and has not been connected to a remote party. The Home menu displays the image shot by the local camera, local system name, current date and time and buttons to open the menus.

You can select the items shown in the Home menu using the Home Menu 1 to Home Menu 3 pages in the Home Menu setup menu.

The descriptions of the items displayed in the Home menu are given below using the default menu and the menu with all items shown, as the examples.

Home menu (default)

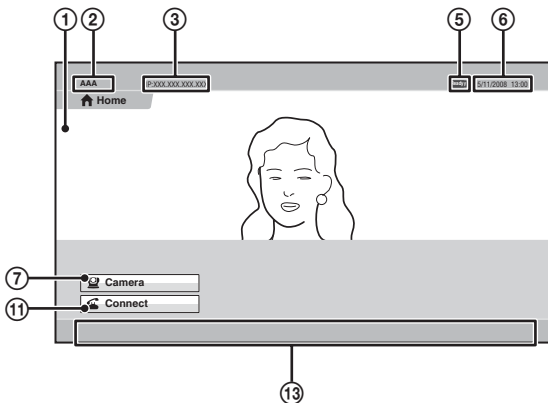

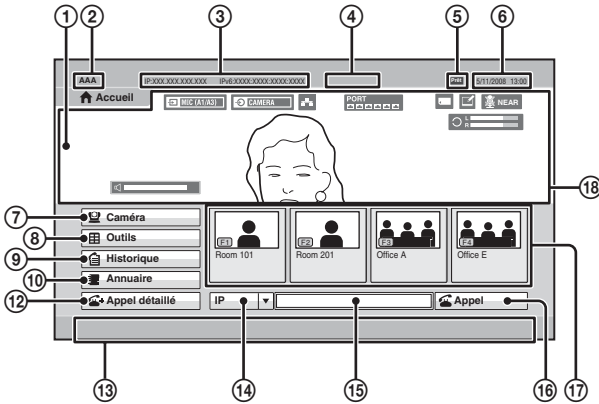

① Background screen

Image shot by the camera is displayed.

② Local terminal name

The local terminal name set in the menu is displayed.

③ IP address of the local system

The IP address of the local system is shown.

When “Internet Protocol” is set to “IPv4/IPv6” in the Administrator setup menu, the IPv6 IP address is also displayed.

Note

The first set of digits is not displayed for IPv6 IP addresses.

By changing the “Number Display” setting (page 76) on the Home Menu 1 page of the Home Menu setup menu, you can display the gatekeeper’s user name and user number, NAT address, etc. instead of the IP address.

④ ISDN line number

The ISDN line number of the local system is shown.

⑤ Local system status

The status on the local terminal is shown.

⑥ Date and time

The current date and clock are displayed.

⑦ Camera button

The Camera menu opens when you select the button and press the ENTER button on the Remote Commander.

The Camera menu is used to adjust the camera brightness, or to preset the camera adjustments and to move the camera to the preset position.

Camera menu

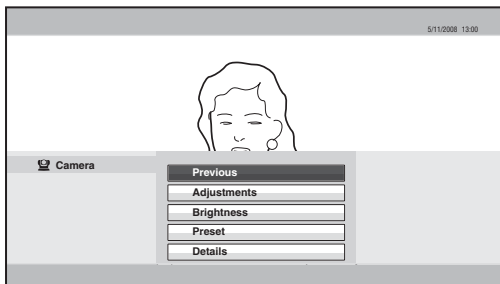

For details on the Camera menu, see page 125.

⑧ Tools button

The Tools menu opens when you select the button and press the ENTER button on the Remote Commander.

The menu is used to carry out presentation, streaming, recording, annotation, etc. The Machine Status menu or Setup menu can be displayed using the buttons in the Tools menu.

Tools menu

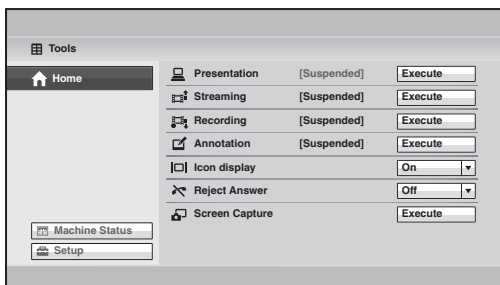

For details on the Tools menu, see page 139.

For details on the Machine Status menu, see page 83.

For details on the Setup menu, see page 54.

⑨ History button

The History menu opens when you select the button and press the ENTER button on the Remote Commander.

The menu is used to check the incoming call and outgoing call histories or to call a remote party from the history list.

History menu

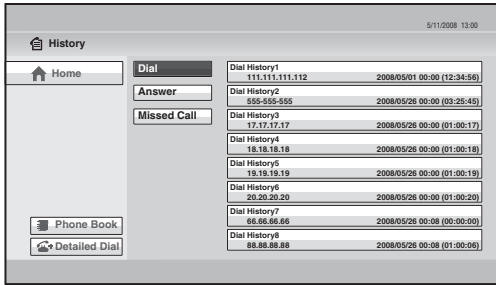

For details on the History menu, see page 102.

⑩ Phone Book button

The Phone Book opens when you select the button and press the ENTER button on the Remote Commander.

The menu is used to register a remote party to the Phone Book or to call a remote party registered in the Phone Book.

Phone Book

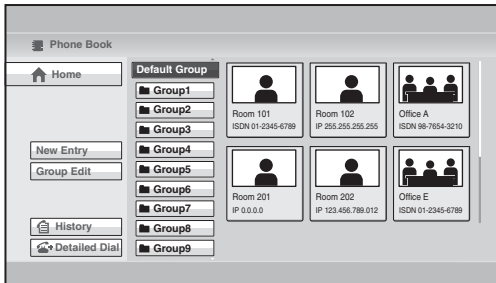

For details on the Phone Book, see page 112.

⑪ Connect button

The Connect menu opens when you select “Connect” in the Home menu and press the ENTER button on the Remote Commander.

The Connect menu is used to call a remote party.

Connect menu

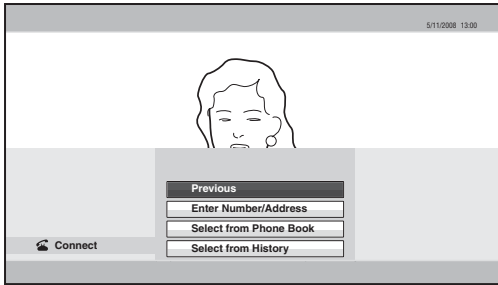

For details, see “Calling a Remote Party by Using the Connect Menu” on page 99.

⑫ Detailed Dial button

The Detailed Dial menu opens when you select the Detailed Dial button and press the ENTER button on the Remote Commander. The menu is used to call a remote party by setting the details of the dial setup options.

Detailed Dial menu

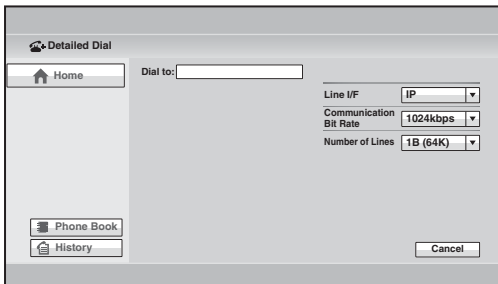

For details on the Detailed Dial menu, see page 105.

⑬ Instruction display

The instructions for the operation in the Home menu are displayed.

⑭ Line interface select button

Selecting the button opens the drop-down list of the line interface. Select the interface to be used, then press the ENTER button.

⑮ Number input box

To call a remote party not registered in the Phone Book, select the box and enter the party's IP address, Domain name, ISDN line number, etc.

16 Dial button

To call a remote party whose number or address has been entered in the number input box, select this button, then press the ENTER button on the Remote Commander.

17 One-touch dial buttons

The submenu is displayed when you select a thumbnail for a remote party you want to call and press the ENTER button on the Remote Commander. Using the submenu you can call the remote party.

You can also call the remote parties assigned to the one-touch buttons by pressing the F1 to F4 buttons on the Remote Commander.

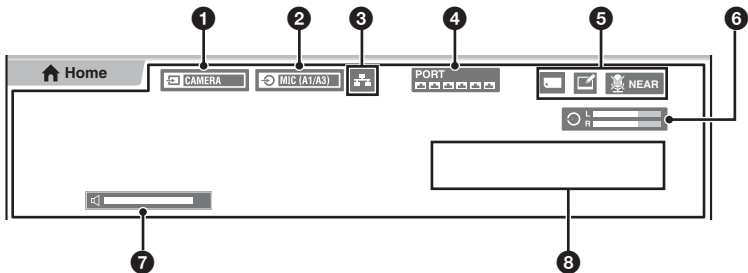
18 Display**1 Video input**

The selected video input on the local system is displayed. The displayed video input is shown as the label set in “Custom Input Label” in the Video setup menu.

2 Audio input

The selected audio input on the local system is displayed.

3 LAN status

The current status of LAN connection is shown. The LAN indicator is shown in white when LAN is enabled for use and in gray when it is disabled.

4 ISDN status

The current status of the ISDN unit ports is shown. The port indicator is shown in white when it is enabled for use and in gray when it is disabled.

5 Indicators

The status indicators for when the microphone is off, a “Memory Stick” is inserted, a pen tablet is connected, streaming broadcast is being executed, recording is being executed, etc. are displayed.

6 Audio level meter

The current audio input level is displayed.

7 Volume

The volume-level bar is temporarily shown when you adjust the volume of the Communication System.

8 Warning messages

If system malfunction occurs, a warning, instruction, etc. are displayed.

Operation Using the Menu

The basic operation through the menu is explained taking manual brightness adjustment in the Camera menu as an example.

Buttons used for menu operations

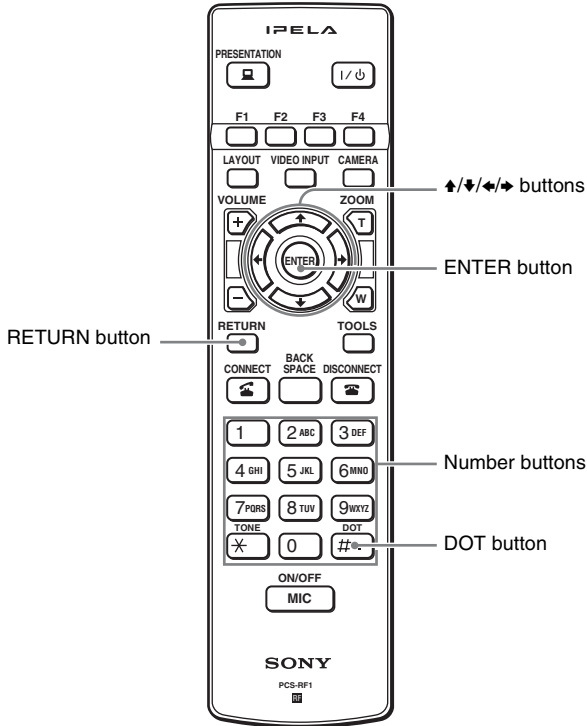

1 Display the Home menu.

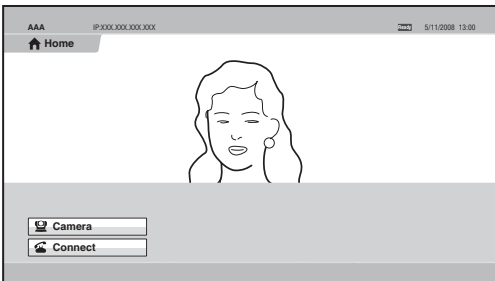

- 2** Use the **↑**, **↓**, **←** or **→** button on the Remote Commander to select “Camera”, then press the ENTER button.

The Camera menu appears.

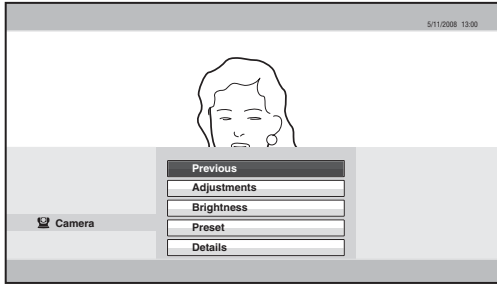

- 3** Use the **↑**, **↓**, **←** or **→** button on the Remote Commander to select “Brightness”, then press the ENTER button.

The Brightness menu appears.

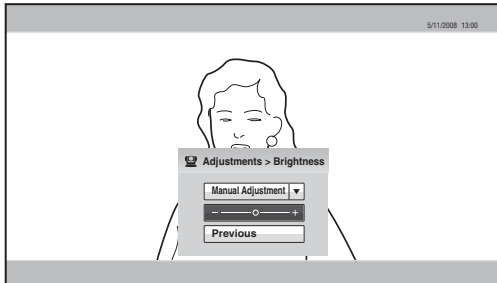

- 4** Use the **↑**, **↓**, **←** or **→** button on the Remote Commander to select the brightness adjustment bar, then press the ENTER button.
- 5** Use the **↑**, **↓**, **←** or **→** button to adjust the brightness of the image, then press the ENTER button.
- 6** Use the **↑**, **↓**, **←** or **→** button on the Remote Commander to select “Previous”, then press the ENTER button after the adjustment is finished. You can also use the RETURN button on the Remote Commander.

The Brightness menu is restored.

- 7** Use the **↑**, **↓**, **←** or **→** button on the Remote Commander to select “Previous”, then press the ENTER button. You can also use the RETURN button on the Remote Commander.

The Camera menu is restored.

When the “Save” button is displayed in the menu

When the setting or adjustment is finished, press the \uparrow , \downarrow , \leftarrow or \rightarrow button on the Remote Commander to select “Save” and press the ENTER button. The setting or adjusted value becomes effective.

When the “Cancel” button is displayed in the menu

If you press the \uparrow , \downarrow , \leftarrow or \rightarrow button on the Remote Commander to select “Cancel” and press the ENTER button, the setting or adjustment is canceled and the previous one is restored.

Entering Characters Using the Remote Commander

This section explains how to enter the letters, numbers or symbols in the text box in the menu using the Remote Commander.

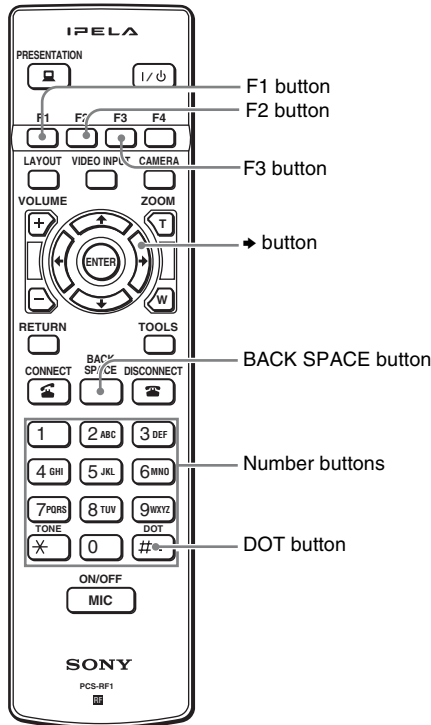

To enter letters or numbers

- 1 Press the F1 button repeatedly to enable the letters or numbers to be input.
- 2 Press the number buttons to enter a letter or number you want.
You can enter the letter shown on each button by pressing it repeatedly.
You can enter the number shown on each button by pressing it once.

To enter a symbol

Press the F2 button repeatedly to select the desired symbol. Pressing the 0 button repeatedly also enables you to enter a symbol.

To enter a dot (.) for an IP address

Press the **▶** button or DOT button.

Note

When “Internet Protocol” is set to “IPv6” or “IPv4/IPv6” in the Administrator setup menu, you can enter colons (:).

When “IPv4/IPv6” is specified, only colons can be entered with the **▶** button. When “IPv4/IPv6” is specified and you are calling using IPv4, press the DOT button twice to enter a dot.

To delete a character

Press the BACK SPACE button. The last entered character is deleted.

To delete all the characters entered

Press the F3 button.

Entering Characters Using the On-Screen Keyboard

This section explains how to enter the letters or numbers in the text box in the menu using the on-screen keyboard displayed on the monitor screen.

When “Display On-Screen Keyboard” is set to “On” in the Menu Screens page of the General setup menu (page 75), the on-screen keyboard automatically appears on the screen if character input is required in the menu.

Note

You can also use the buttons on the Remote Commander even when the on-screen keyboard is displayed on the screen.

To enter letters or numbers

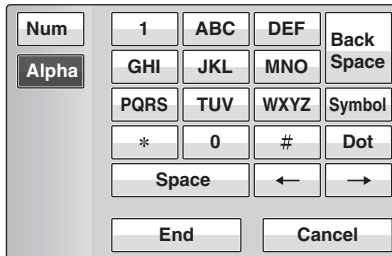

- 1 Use the **▲**, **▼**, **◀** or **▶** button on the Remote Commander to select “Num” or “Alpha” on the on-screen keyboard, then press the ENTER button. Select “Num” to enter numbers, and “Alpha” to enter alphabetic letters.
- 2 Use the **▲**, **▼**, **◀** or **▶** button on the Remote Commander to select the button on the on-screen keyboard on which the desired character is indicated, then press the ENTER button.

When you select a number, the selected number is entered.

When you select an alphabetic letter, a submenu with available letters appears on the on-screen keyboard. Select the desired letter and press the ENTER button on the Remote Commander. The selected letter is entered.

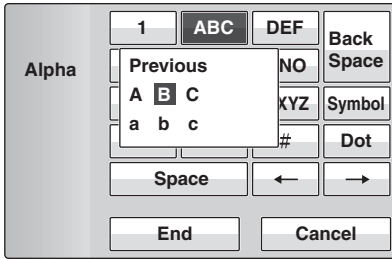

- 3** Repeat step **2** to enter all the letters or numbers.
- 4** After the input is complete, select “End”, then press the ENTER button on the Remote Commander.

To enter a symbol

- 1** Select “Symbol” on the on-screen keyboard, then press the ENTER button on the Remote Commander.
The submenu with available symbols are displayed.
- 2** Use the **↑**, **↓**, **←** or **→** button on the Remote Commander to select the desired symbol, then press the ENTER button.
The selected symbol is entered.
- 3** Repeat steps **1** and **2** to enter all the symbols.
- 4** After the input is complete, select “End”, then press the ENTER button on the Remote Commander.

To enter a dot (.) for an IP address

Select “**→**” or “Dot” on the on-screen keyboard, then press the ENTER button on the Remote Commander.

To enter a space

Select “Space”, then press the ENTER button on the Remote Commander.

To delete a character

To erase the last entered character, select “Back Space”, then press the ENTER button on the Remote Commander.

To delete all the characters entered

Select “Cancel”, then press the ENTER button on the Remote Commander. Pressing the F3 button on the Remote Commander also deletes all the characters entered.

Chapter 2: Registration and Setup for System Administrators

This chapter describes the registration and settings to be carried out by the system administrator. The chapter is intended to be read by the system administrator.

Registering Local Information

Before connecting, set up the local system using the Setup menus. This section describes how to display the Setup menus and gives a introduction to the menus.

Opening the Setup Menu

- 1 Press the Tools button on the Remote Commander, or use the **↑**, **↓**, **←** or **→** button to select “Tools” in the Home menu, then press the ENTER button. The Tools menu appears on the monitor screen.

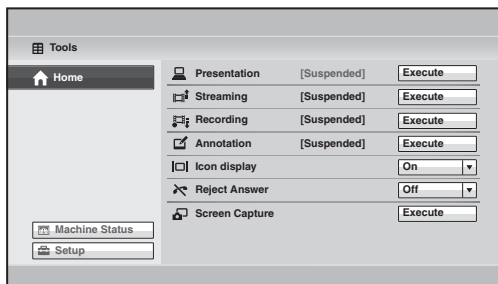



- 2 Use the **↑**, **↓**, **←** or **→** button to select “Setup”, then press the ENTER button on the Remote Commander.

The Setup menu appears on the monitor screen.

Menus available from a setup menu

The Setup menus are grouped into the following depending on the setting items. The setup menus that include many setting items are divided into multiple pages. Select an appropriate menu button to set the respective item.

The commonly-used menu buttons are displayed on the screen at the factory. Pressing the F4 button on the Remote Commander allows you to display the maximum number of setup menu buttons. To restore the commonly-used setup display, press the F4 button again.

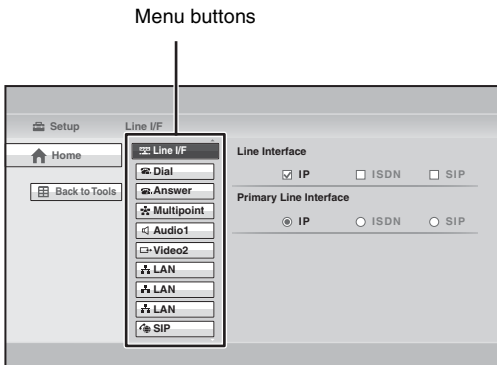

For a description of each setup menu, see the page for that menu indicated below.

- Line Interface setup menu (see page 57)
- Dial setup menu (see page 57)
- Answer setup menu (see page 58)
- Multipoint setup menu (see page 58)
- Communication setup menu (see page 59)
- Audio setup menu (see page 62)
- Video setup menu (see page 65)
- LAN setup menu (see page 66)
- QoS setup menu (see page 69)
- TOS setup menu (see page 70)
- SIP setup menu (see page 71)
- ISDN setup menu (see page 71)
- Annotation setup menu (see page 73)
- Camera setup menu (see page 74)
- General setup menu (see page 74)
- Home Menu setup menu (see page 76)
- Administrator setup menu (see page 77)
- Encryption setup menu (see page 82)
- Shared Phone Book setup menu (see page 82)

- 3** Use the **↑**, **↓**, **←** or **→** button on the Remote Commander to select the menu button you want to set, then press the **ENTER** or **→** button.
The selected setup menu appears.

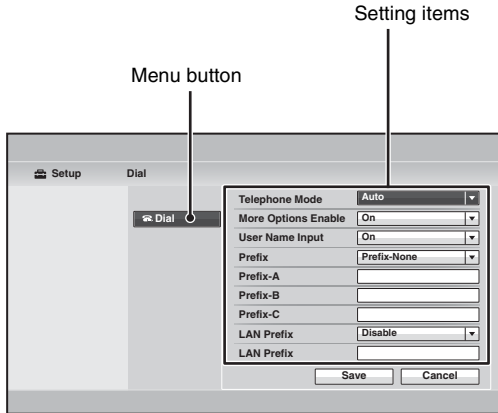

- 4** Use the **↑**, **↓**, **←** or **→** button on the Remote Commander to select the setting item, then press the **ENTER** button.

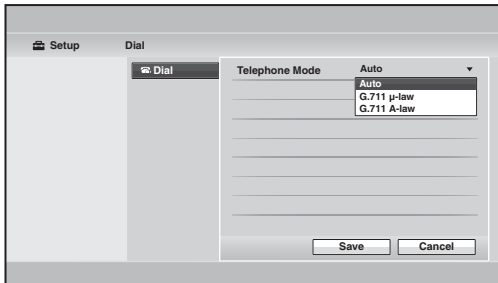

- 5** Select the desired item from the drop-down list, or enter the characters in the text box.

For individual items, see pages 57 to 82.

- 6** After the selection or character input is completed, use the **↑**, **↓**, **←** or **→** button to select “Save”, then press the **ENTER** button.
The setting is saved, and the Setup menu is restored.

To cancel the setup

Use the **↑**, **↓**, **←** or **→** button on the Remote Commander to select “Cancel”, then press the **ENTER** button. Or press the **RETURN** button on the Remote Commander.

To return to the left column

Press the **←** button or **RETURN** button on the Remote Commander.

Line Interface Setup Menu

The Line Interface setup menu is used to select the line interface you use for connection with a remote party.



Line Interface

Allows you to select the line interface from among "IP", "ISDN" and "SIP". You can select multiple interfaces.

Primary Line Interface

Allows you to select the line interface you use most from among IP, SIP and ISDN.

Dial Setup Menu

The Dial setup menu is used to set the attributes for dialing.



Telephone Mode

Allows you to select the audio compression format when conducting a voice meeting.

Auto: Selects an appropriate format automatically.

G.711 μ -law: Selects the format based on the G.711 μ -law standard.

G.711A-law: Selects the format based on the G.711A-law standard.

More Options Enable

Allows you to select whether to display the More Options button in the List Edit menu of the Phone Book. You can set the detailed items for dialing in the List Edit menu by selecting the More Options button.

On: Displays the More Options button.

Off: Does not display the More Options button.

User Name Input

Allows you to select whether to register user names in the communications log when connection is made.

Off: Disables the recording of the user names.

On: Select when you want to record user names. Each time dialing takes place, the user name input menu appears.

Prefix

Select the prefix number (call number prefixed to a line number).

Prefix-None: Select when you are not using a prefix number.

Prefix-A: Select when you use the prefix set in "Prefix-A".

Prefix-B: Select when you use the prefix set in "Prefix-B".

Prefix-C: Select when you use the prefix set in "Prefix-C".

Prefix-A

When "Prefix" is set to "Prefix-A", the line number prefixed by the prefix (dial number) registered in this box is dialed.

Prefix-B

When "Prefix" is set to "Prefix-B", the line number prefixed by the prefix (dial number) registered in this box is dialed.

Prefix-C

When "Prefix" is set to "Prefix-C", the line number prefixed by the prefix (dial number) registered in this box is dialed.

Note

Enter "9" when this is required to make an outgoing call.

Select LAN Prefix

Allows you to select whether to use the LAN prefix when dialing via a LAN.

Disable: Disables the LAN prefix.

Enable: Enables the LAN prefix.

LAN Prefix

When dialing using the IP connection, the information entered into this box is added to the beginning of the IP address. Select whether to use the LAN prefix in "Select LAN Prefix".

Answer Setup Menu

The Answer setup menu is used to set up call reception.

 Answer

Answer

Auto Answer

Allows you to select whether the system answers calls automatically.

On: Answers calls automatically. When a call comes in, the line is automatically connected.

Off: Allows you to answer calls manually. When a call comes in, the phone rings. If you select “OK” in the “Answer?” message, the line is connected.

ISDN MSN

Allows you to select whether you are using the Multiple Subscriber Number.

Off: Select when you do not use the Multiple Subscriber Number.

On: Select when you use the Multiple Subscriber Number.

Mic on Answer

Allows you to select whether to transmit audio from your site when you receive a call and connect it.

On: Enables transmission of audio when answering a call.

Off: Disables transmission of audio when answering a call.

For details, see “Turning Off the Sound Momentarily – Muting Function” on page 123.

Reject Answer

Allows you to select whether to connect a remote party’s calling during communication.

On: Disables the connection of a remote party.

Off: Enables the connection of a remote party.

Multipoint Setup Menu

The Multipoint setup menu is used to set up multipoint connection when the local system is used as the main terminal.

 Multipoint

Multipoint

Multipoint Mode

AUTO: Switches from point-to-point connection to multipoint connection automatically.

On: Enables you to make a multipoint connection at any time.

Broadcast Mode

Allows you to select the broadcast mode.

Split: Displays the picture from the connected terminals in split windows.

Voice Activate: Detects the terminal where a speaker has the loudest voice, and automatically transmits the picture of this terminal to all other terminals.

Voice Activate (720P): Enables transmission of pictures with resolution of 720p (1280 × 720 pixels) in H.264 Video Mode when “Voice Activate” mode is activated.

Notes

- The “Voice Activate (720P)” mode cannot be selected when the communication is made via an ISDN or SIP connection. Even for an IP connection, this mode is not available if the remote party does not support H.264 Video Mode.
- When “Broadcast Mode” is set to “Voice Activate (720P)”, you cannot change “Broadcast Mode” during communication. Select the Broadcast Mode before starting communication.

Split

Allows you to select the type of split display used to display local and remote pictures on a single monitor during a multipoint connection.

Four-screen Mosaic: The display is split into four parts.

Six-screen Mosaic: The display is split into six parts.

Note

When there is only one terminal connected, the display switches to full screen regardless of the selection of the setting.

Communication Setup Menu

The Communication setup menu is used to set up communications.

Note

The contents of the Communication setup menu vary with “Line Interface” setting in the Line I/F setup menu, or “Individual Settings for Transmission/Reception” or “Individual Settings for Point-to-Point/Multipoint” setting in the Communication setup menu. Only the settings that can be configured will appear on the screen.

The Communication page number after the Communication2 page also varies according to the number of setting items.



The menu is used to set up the communication mode for the IP connection.

Individual Settings for Transmission/Reception

Allows you to select whether to configure the IP settings for transmission and reception individually.

Off: Select to configure the IP settings for transmission and reception commonly.

On: Select to configure the IP settings for transmission and reception individually.

Individual Settings for Point-to-Point/Multipoint

Allows you to select whether to configure the IP settings for a point-to-point connection and multipoint connection individually.

Off: Select to configure the IP settings for both connections commonly.

On: Select to configure the IP settings for a point-to-point connection and multipoint connection individually.

Note

The setting items and page numbers in the IP: Mode page vary according to the setting of “Individual Settings”.



Total Bandwidth

Allows you to select the total bandwidth to be used with this system.

In multipoint connection, the total bandwidth of all points is displayed.

You can select from among 128Kbps, 384Kbps, 512Kbps, 1Mbps, 2Mbps, 3Mbps, 4Mbps, and Other.

Note

In multipoint connection, the actual Communication Bit Rate for each point is automatically adjusted so as not to exceed “Total Bandwidth”.

Communication Bit Rate

Allows you to select the communication bit rate per point.

When “Individual Settings for Transmission/Reception” or “Individual Settings for Point-to-Point/Multipoint” on the IP page is set to “On”, you can set this item for transmission and reception, and point-to-point and multipoint connections individually.

You can select from among 128Kbps, 384Kbps, 512Kbps, 1Mbps, 2Mbps, 3Mbps, 4Mbps and Other.

Audio Mode

Allows you to select the compression format of audio to be sent to a remote party.

When “Individual Settings for Transmission/Reception” or “Individual Settings for Point-to-Point/Multipoint” on the IP page is set to “On”, you can set this item for transmission and reception, and point-to-point and multipoint connections individually.

You can select multiple formats from among G.711, G.722, G.728 and MPEG4 (MPEG4 AAC).

Note

When the remote system does not support the audio mode selected by the local site, the mode automatically becomes "G.711".

Far End Camera Control

Allows you to select whether to enable the control of each other's cameras from each other's site.

When "Individual Settings for Point-to-Point/Multipoint" for IP is set to "On", you can set this item individually for point-to-point and multipoint connections.

On: Enables the control of each other's cameras. Normally, set to "On".

Off: Disables the control of each other's cameras.

H.239

Use of the presentation mode complying with H.239 allows you to transmit the presentation data and picture from the camera simultaneously.

This item allows you to select whether to use the presentation mode based on the H.239 presentation standard.

On: Enables the presentation mode based on the H.239 presentation standard.

Off: Disables the presentation mode based on the H.239 presentation standard.

H.239 Ratio

When H.239 presentation transmissions are made with the system, the H.239 presentation data shares bandwidth with camera images that are also being sent. This setting allows you to select how much of the total bandwidth to use for H.239 presentation data transmissions.

2/3: Use 2/3 of the total bandwidth for H.239 presentation data transmissions.

1/2: Use 1/2 of the total bandwidth for H.239 presentation data transmissions.

1/3: Use 1/3 of the total bandwidth for H.239 presentation data transmissions.

Screen Size

Allows you to select the screen size of the picture to be transmitted or received.

When "Individual Settings for Transmission/Reception" or "Individual Settings for Point-to-Point/Multipoint" on the IP page is set to "On", you can set this

item for transmission and reception, and point-to-point and multipoint connections individually.

You can select from among 720, W4CIF, W432P, WCIF, 4CIF, CIF, QCIF and AUTO.

Video Mode

Allows you to select the compression format of pictures to be transmitted or received.

When "Individual Settings for Transmission/Reception" or "Individual Settings for Point-to-Point/Multipoint" on the IP page is set to "On", you can set this item for transmission and reception, and point-to-point and multipoint connections individually.

You can select from among H.261, H.263+, and H.264.

Video Frame

Allows you to select the number of video frames during transmission or reception.

When "Individual Settings for Transmission/Reception" or "Individual Settings for Point-to-Point/Multipoint" on the IP page is set to "On", you can set this item for transmission and reception, and point-to-point and multipoint connections individually.

15fps: Send pictures at a maximum rate of 15 frames per second.

30fps: Send pictures at a maximum rate of 30 frames per second.

60fps: Send pictures at a maximum rate of 60 frames per second.

AUTO: Switch the number of frames automatically.

Communication ISDN

The menu is used to set up the communication mode for an ISDN connection.

Individual Settings for Point-to-Point/Multipoint

Allows you to select whether to configure the ISDN settings for point-to-point and multipoint connections individually.

Off: Select to configure the ISDN settings for both connections commonly.

On: Select to configure the ISDN settings for point-to-point and multipoint connections individually.

Note

The setting items and page numbers for “ISDN: Mode” varies according to the setting of “Individual Settings”.

Communication

ISDN: Mode

ISDN Bandwidth (Dial)

Allows you to select the number of ISDN lines used for dialing.

When “Individual Settings for Point-to-Point/Multipoint” on the ISDN page is set to “On”, you can set this item for point-to-point and multipoint connections individually. You can select from among 1B (64K), 2B (128K), 3B (192K), 4B (256K), 5B (320K), 6B (384K), 8B (512K) and 12B (768K).

ISDN Bandwidth (Answer)

Allows you to select the number of ISDN lines used for answering.

When “Individual Settings for Point-to-Point/Multipoint” on the ISDN page is set to “On”, you can set this item for point-to-point and multipoint connections individually. You can select from among 1B (64K), 2B (128K), 3B (192K), 4B (256K), 5B (320K), 6B (384K), 8B (512K) and 12B (768K).

Audio Mode

Allows you to select the compression format of audio to be sent to a remote party.

When “Individual Settings for Point-to-Point/Multipoint” on the ISDN page is set to “On”, you can set this item for point-to-point and multipoint connections individually. You can select from among G.711, G.722, G.728 and MPEG4 (MPEG4 AAC).

Note

When the remote system does not support the audio mode selected by the local site, the mode automatically becomes “G.711”.

Far End Camera Control

Allows you to select whether to enable the control of each other’s cameras from each other’s site.

When “Individual Settings for Point-to-Point/Multipoint” on the ISDN page is set to “On”, you can set this item for point-to-point and multipoint connections individually.

On: Enables the control of each other’s cameras. Normally, set to “On”.

Off: Disables the control of each other’s cameras.

H.239

Allows you to select whether to use the presentation mode based on the H.239 presentation standard.

On: Enables the presentation mode based on the H.239 presentation standard.

Off: Disables the presentation mode based on the H.239 presentation standard.

H.239 Ratio

When H.239 presentation transmissions are made with the system, the H.239 presentation data shares bandwidth with camera images that are also being sent. This setting allows you to select how much of the total bandwidth to use for H.239 presentation data transmissions.

2/3: Use 2/3 of the total bandwidth for H.239 presentation data transmissions.

1/2: Use 1/2 of the total bandwidth for H.239 presentation data transmissions.

1/3: Use 1/3 of the total bandwidth for H.239 presentation data transmissions.

Restrict

Allows you to select the ISDN transmission rate.

Auto: Select when connecting a remote party via a normal ISDN line.

56K: Select when connecting a remote party located in a region or country where the ISDN transmission rate is 56 Kbps.

Note

The system is set to connect an ISDN line at the transmission rate of 64 Kbps by default. However, some countries, such as the USA, and some regions may use the ISDN transmission rate of 64 Kbps and 56 Kbps. You may not communicate with such countries or regions at 64 Kbps, so you must therefore set “Restrict” to “56K” before dialing.

Screen Size

Allows you to select the screen size of the picture to be transmitted or received. When “Individual Settings for Point-to-Point/Multipoint” on the ISDN page is set to “On”, you can set this item for point-to-point and multipoint connections individually. You can select from among W4CIF, W432P, WCIF, 4CIF, CIF and AUTO.

Video Mode

Allows you to select the compression format of pictures to be transmitted or received. When “Individual Settings for Point-to-Point/Multipoint” on the ISDN page is set to “On”, you can set this item for point-to-point and multipoint connections individually. You can select from among H.261, H.263+, and H.264.

Video Frame

Allows you to select the number of video frames during transmission or reception. When “Individual Settings for Point-to-Point/Multipoint” on the ISDN page is set to “On”, you can set this item for point-to-point and multipoint connections individually.

15fps: Send pictures at a maximum rate of 15 frames per second.

30fps: Send pictures at a maximum rate of 30 frames per second.

AUTO: Switch the number of frames automatically.

 Communication

SIP: Mode

Communication Bit Rate

Allows you to select the communication bit rate per point. You can select from among 128Kbps, 384Kbps, 512Kbps, 1Mbps, 2Mbps, 3Mbps, 4Mbps and Other.

Audio Mode

Allows you to select the compression format of audio to be sent to a remote party. You can select from among G.728, G.722 and G.711.

Note

When the remote system does not support the audio mode selected by the local site, the mode automatically becomes “G.711”.

Far End Camera Control

Allows you to select whether to enable the control of each other’s cameras from each other’s site.

On: Enables the control of each other’s cameras. Normally, set to “On”.

Off: Disables the control of each other’s cameras.

Screen Size

Allows you to select the screen size of the picture to be transmitted or received. You can select from among 720, W4CIF, W432P, WCIF, 4CIF, CIF, QCIF and AUTO.

Video Mode

Allows you to select the compression format of pictures to be transmitted or received. You can select from among H.261, H.263+, H.264 and MPEG4.

Video Frame

Allows you to select the number of video frames during transmission or reception.

15fps: Send pictures at a maximum rate of 15 frames per second.

30fps: Send pictures at a maximum rate of 30 frames per second.

60fps: Send pictures at a maximum rate of 60 frames per second.

AUTO: Switch the number of frames automatically.

Audio Setup Menu

The Audio setup menu is used to set various audio items.

 Audio1

Basic Setup1

Audio Input

Allows you to select the audio input.

MIC: Inputs audio from the microphone.

AUX: Inputs audio from auxiliary external equipment.

MIC+AUX: Inputs audio from the microphone and auxiliary external equipment.

Note

When “Link to Audio Input” is set to “On” in the Video setup menu, “Audio Input”, “Input Select (MIC)” and “Input Select (AUX)” cannot be selected.

Input Select (MIC)/ Input Select (AUX)

Allows you to select the microphone and/or external equipment from which an audio signal is input.

The options that can be selected vary with the Audio Input setting.

When you select “MIC”, you can select one of the following three options. When you select “AUX”, “AUDIO” is selected. When you select “MIC+AUX”, you can select the “MIC (Camera)” or “MIC (A1/A3)” option for MIC, and “AUDIO” is selected for AUX.

MIC (Camera): Select to use the microphone that is built into the camera portion of the system.

MIC (A1/A3): Select use of the PCS-A1 microphone (not supplied) or PCSA-A3 microphone (not supplied) connected to the MIC (A1/A3) jacks on the Communication System.

AUDIO: Select to input the audio of external equipment connected to the AUDIO IN jack on the Communication System.

Echo Canceller

Allows you to select whether to use the internal echo canceller.

On: Enables the internal echo canceller.

Off: Disables the internal echo canceller.

Note

When “Audio Input” is set to “AUX”, the echo canceller will not function.

Lip Sync

Allows you to select whether to use the Lip Sync function.

Auto: Enables the Lip Sync function.

Off: Disables the Lip Sync function.

Notes

- When “Adaptive Rate Control (ARC)”, “Packet Resend Request (ARQ)” or “Forward Error Correction (FEC)” is set to “On” in the QoS setup menu, you cannot set “Lip Sync” to “Off”.
- When “Lip Sync” is set to “Off”, you cannot change the setting for “Adaptive Rate Control (ARC)”, “Packet Resend Request (ARQ)” or “Forward Error Correction (FEC)” in the QoS setup menu.

Recording Mute

When you connect an audio recording device to the AUDIO IN and REC OUT jacks to record audio, this function reduces oscillations in sound that occur due to loop-back within audio recording device.

Off: Disables the recording mute function.

On: Enables the recording mute function.

Notes

- When “Recording Mute” is set to “On”, only signals from external equipment are affected. Signals from the microphones or remote sites are not affected. Therefore, the Recording Mute functions only when “Audio Input” is set to “AUX” or “MIC+AUX.”
- When connecting an audio recording device to the AUDIO IN and REC OUT jacks, set “Recording Mute” to “On” and record the sound only from the audio recording device. If you want to record the sound on your site as well, also use the microphone input.

Input Mode

Allows you to select the input audio mode.

Stereo: Inputs audio to the R/L jacks of the audio input as stereo left and right sounds.

Monaural: Inputs audio to the R/L jacks of the audio input as monaural sound.

Output Mode

Allows you to select the output audio mode.

Stereo: Outputs audio from the system’s speakers or from the ◡ (headphone) jack as left/right stereo sound.

Monaural: Outputs audio from the system’s speakers or from the ◡ (headphone) jack as two-channel monaural sound.

AUX Local Monitor Out

Allows you to select whether the audio input from the AUDIO IN jacks outputs to the audio output jacks on the Communication System.

On: Enables output from the audio output.

Off: Disables output from the audio output.

Reversed MIC Inputs

Allows you to select whether to transmit the audio input from the microphone with right and left reversed. If you select “On”, you can match the right and left of the camera image and audio.

Off: Transmits the audio with right and left not reversed.

On: Transmits the audio with right and left reversed.

Audio Input Delay Setting

Allows you to set Audio Input Delay to synchronize the audio with the video input.

Default –100ms: Selects the default delay minus 100ms.

Default –50ms: Selects the default delay minus 50ms.

Default: Selects the default delay.

Default + 50ms: Selects the default delay plus 50ms.

Default + 100ms: Selects the default delay plus 100ms.

Custom: Uses the Audio Input Delay you set.

Audio Input Delay

When you set “Audio Input Delay Setting” to “Custom”, you can set the delay time of the input audio to match the image and audio.

Audio Output Delay Setting

Allows you to set Audio Output Delay to synchronize the audio with the video output.

Default –100ms: Selects the default delay minus 100ms.

Default –50ms: Selects the default delay minus 50ms.

Default: Selects the default delay.

Default + 50ms: Selects the default delay plus 50ms.

Default + 100ms: Selects the default delay plus 100ms.

Custom: Uses the Audio Output Delay you set.

Audio Output Delay

When you set “Audio Output Delay Setting” to “Custom”, you can set the delay time of the output audio to match the image and audio.

REC OUT Mode

Stereo: The mixed sounds of the remote and local sites are output from the REC OUT R and L jacks in stereo.

Monaural 2ch: The sounds of the remote and local sites are output from the REC OUT R and L jacks separately.

Lens Cover Mic On/Off Function

Select whether the mic turns on or off based on whether the lens cover is open or closed.

On: When the lens cover is closed, the mic turns off.

Off: Opening and closing of the lens cover does not affect the mic.

Beep Sound

Allows you to select the volume of the beep that sounds each time you press a button on the Remote Commander from among “Loud”, “Medium” and “Quiet”. You can also select “Off” for the beep not to sound.

Sound Effect

Allows you to select the volume of output sound when the system starts, or when connection starts or is disconnected from among “Loud”, “Medium” and “Quiet”. You can also select “Off” for the sound not to be output.

Dial Tone

Allows you to select the volume of a ring-back and busy tones when you are dialing from among “Loud”, “Medium” and “Quiet”. You can also select “Off” for the ring-back and busy tones not to be output.

Ringer Tone

Allows you to select the volume of a ring tone when you receive a call from among “Loud”, “Medium” and “Quiet”. You can also select “Off” for the ring tone not to be output.

Video Setup Menu

The Video setup menu is used to set up video input/output.

Video1 Basic Setup

Video Input

Allows you to select the video input.

Camera: Selects the camera picture from the built-in camera.

RGB: Selects the video signal from the external equipment connected to the RGB IN connector.

Presentation Screen

Allows you to select the display pattern of the presentation screen.

The “Presentation Screen” settings are enabled when the PCSA-DSG80 HD Data Solution Software (not supplied) is installed, and “H.239” is disabled during the communication.

Full Screen: Sends the computer picture, etc. from the external equipment connected to the RGB IN connector in full screen mode.

PandP: Sends the computer picture, etc. from the external equipment connected to the RGB IN connector and the selected input picture such as a camera picture in PandP mode.

Side by Side: Sends the computer picture, etc. from the external equipment connected to the RGB IN connector and the selected input picture such as a camera picture in Side by Side mode.

Monitor Output

Allows you to select the video signal output from the Communication System.

Single: Outputs the video signal to the system’s monitor.

Dual: Outputs the video signal to both the system’s monitor and the external device connected to the RGB OUT connector.

RGB Monitor Output Format

Allows you to select the format of the signal output from the RGB OUT connector.

SXGA: Outputs the SXGA signal.

XGA: Outputs the XGA signal.

WXGA: Outputs the WXGA signal.

Blanking Period

Allows you to select the duration of the blackout period that occurs temporarily on the monitor of the Communication System when the input picture is switched.

You can select among from Long, Medium and Short.

Video2 Custom Input Label

Allows you to set the names of the selected video inputs using up to 12 characters.

Custom Input Label (Camera)

Selects when “Camera” is selected in “Video Input”.

Custom Input Label (RGB)

Selects when “RGB” is selected in “Video Input”.

Video3 Link to Mic

Allows you to select whether to link an audio input to the selected video input.

Link to Audio Input

Allows you to switch the audio input in conjunction with switching the video input by linking each video input and a specific microphone or other audio input.

Off: Switches the video input and the microphone or other audio input separately.

On: Links switching of the video input and the microphone or other audio input.

Note

When “Link to Audio Input” is set to “On”, “Audio Input”, “Input Select (MIC)” and “Input Select (AUX)” on the Basic Setup1 page of Audio setup menu cannot be selected.

Video Input

Allows you to select the video input.

Camera: Selects the camera picture from the built-in camera.

RGB: Selects the picture from the external equipment connected to the RGB IN connector.

Audio Input

Allows you to select the audio input which is linked to the video input selected in “Video Input” when “Link to Audio Input” is set to “On”.

MIC: Inputs audio from the microphone.

AUX: Inputs audio from the external equipment.

MIC+AUX: Inputs audio both from the microphone and external equipment.

Input Select (MIC)

Input Select (AUX)

Allows you to select the audio input from the microphone and/or external equipment when “Link to Audio Input” is set to “On”. The options that can be selected vary with the Audio Input setting.

When you select “MIC”, you can select one of the following three options. When you select “AUX”, “AUDIO” is selected. When you select “MIC+AUX”, you can select the “MIC (Camera)” or “MIC (A1/A3)” option for MIC, and “AUDIO” is selected for AUX.

MIC (Camera): Select to use the microphone that is built into the camera portion of the system.

MIC (A1/A3): Select use of the PCSA-A1 microphone (not supplied) or PCSA-A3 microphone (not supplied) connected to the MIC (A1/A3) jacks on the Communication System.

AUDIO: Select to input the audio of external equipment connected to the AUDIO IN jack on the Communication System.

LAN Setup Menu

The LAN setup menu is used to set up LAN connection.

For details about the settings, consult your network administrator.

Note

The contents of the LAN setup menu vary depending on the “Internet Protocol” setting in the Administrator setup menu.

The page numbers also vary according to the number of setting items.

LAN

Basic Setup:

LAN1

Host Name

Enter your host name (up to 30 characters).

DHCP Mode

Allows you to select whether the Dynamic Host Configuration Protocol (DHCP) server is enabled.

Auto: The IP address, network mask, gateway address and DNS address are automatically assigned.

Off: Disables the DHCP server. In this case, enter an IP address, network mask, gateway address and DNS address.

Prefix Length

Configure the prefix length of the IPv6 address within the range of 0 to 128.

IP Address

Enter the IP address.

Network Mask

Enter the network mask.

Gateway Address

Enter the default gateway address.

Primary DNS

Enter a primary DNS address.

Secondary DNS

Enter a secondary DNS address.

LAN Mode

Allows you to select the interface type and the communication mode of the LAN connection.

Auto: The interface type and the communication mode are detected automatically.

100Mbps Full Duplex: Connects via 100BASE-TX in full duplex mode.

100Mbps Half Duplex: Connects via 100BASE-TX in half duplex mode.

10Mbps Full Duplex: Connects via 10BASE-T in full duplex mode.

10Mbps Half Duplex: Connects via 10BASE-T in half duplex mode.

LAN **Basic Setup:**

LAN1: IPv6

Note

When “Internet Protocol” is set to “IPv4/IPv6” in the Administrator setup menu, the setup screen for IPv6 appears. In such cases, configure the LAN mode in the IPv6 setup screen.

DHCP Mode

Allows you to select whether the Dynamic Host Configuration Protocol (DHCP) server is enabled.

Auto: The IP address, network mask, gateway address and DNS address are automatically assigned.

Off: Disables the DHCP server. In this case, enter an IP address, network mask, gateway address and DNS address.

Prefix Length

Configure the prefix length of the IPv6 address within the range of 0 to 128.

IP Address

Enter the IP address.

Gateway Address

Enter the default gateway address.

Primary DNS

Enter a primary DNS address.

Secondary DNS

Enter a secondary DNS address.

LAN Mode

Allows you to select the interface type and the communication mode of the LAN connection.

Auto: The interface type and the communication mode are detected automatically.

100Mbps Full Duplex: Connects via 100BASE-TX in full duplex mode.

100Mbps Half Duplex: Connects via 100BASE-TX in half duplex mode.

10Mbps Full Duplex: Connects via 10BASE-T in full duplex mode.

10Mbps Half Duplex: Connects via 10BASE-T in half duplex mode.

LAN **PPPoE**

PPPoE

Allows you to select whether to use PPPoE for LAN connection.

When using PPPoE, you can use the B FLET’S* or FLET’S ADSL service without connecting a router.

Off: Does not use PPPoE.

On: Uses PPPoE for LAN connection using the  (LAN) connector.

Notes

- Operations of PPPoE for LAN connection are presently verified only for the Japanese NTT B FLET’S and FLET’S ADSL services.
- The PPPoE registration status appears at the bottom of the screen for each page.

* “FLET’S” is a trademark of NTT East and NTT West Corporations in Japan.

User Alias

Enter a user name when you use PPPoE for LAN connection.

Password

Enter a password when you use PPPoE for LAN connection.

Fixed IP for PPPoE

Select whether to make a PPPoE connection using a fixed IP address.

Off: Does not use a fixed IP address for a PPPoE connection.

On: Uses a fixed IP address for a PPPoE connection.

Fixed IP Address for PPPoE

Enter an IP address when “Fixed IP for PPPoE” is set to “On”.

DNS

Allows you to select whether to obtain DNS server addresses automatically or to specify them manually when connecting to a LAN using PPPoE.

Obtain automatically: Assigns DNS server addresses automatically.

Specify: Allows you to specify DNS server addresses.

Primary DNS

Enter a primary DNS address.

Secondary DNS

Enter a secondary DNS address.



LAN

NAT Setup

NAT Mode

Allows you to select whether you connect the system to a local network using Network Address Translation (NAT), which allows one IP address to be shared by several computers on the same LAN.

Auto: Enables or disables the NAT mode by automatically detecting the use of NAT.

This option is effective only when you use the UPnP router.

On: Enables NAT mode.

Off: Disables NAT mode.

WAN IP Address

Enter the IP address for the Wide Area Network (WAN).



LAN

Gatekeeper

Note

When “Internet Protocol” is set to “IPv4/IPv6” in the Administrator setup menu, configure the settings in the “Gatekeeper: IPv6” screen.

Gatekeeper Mode

Allows you to select whether to use the gatekeeper to control access to a LAN. Using the gatekeeper allows you to dial using the user name or user number as well as dialing using the IP address.

Auto: Automatically detects the gatekeeper and uses it.

On: Enables the gatekeeper.

Off: Disables the gatekeeper.

Gatekeeper Address

Enter the address of the gatekeeper used when “Gatekeeper Mode” is set to “On”.

User Alias

Enter the user name (H.323 alias) registered in the gatekeeper.

User Number

Enter the user number (E.164 number) registered in the gatekeeper.

H.460

Allows you to select whether to use H.460 to traverse firewalls and connect to the terminals on other networks.

On: Enables connection that traverses H.460 standard firewalls.

Off: Disables connection that traverses firewalls.



LAN

Gatekeeper: IPv6

Note

This appears when “Internet Protocol” is set to “IPv4/IPv6” in the Administrator setup menu.

Gatekeeper Mode

Allows you to select whether to use the gatekeeper to control access to a LAN. Using the gatekeeper allows you to dial using the user name or user number as well as dialing using the IP address.

Auto: Automatically detects the gatekeeper and uses it.

On: Enables the gatekeeper.

Off: Disables the gatekeeper.

Gatekeeper Address

Enter the address of the gatekeeper used when “Gatekeeper Mode” is set to “On”.

User Alias

Enter the user name (H.323 alias) registered in the gatekeeper.

User Number

Enter the user number (E.164 number) registered in the gatekeeper.

LAN **Used Port Number, RTP/RTCP Setup**

Q.931

Enter the Q.931 port number.

H.245

Enter the H.245 port number.

RTP/RTCP

Enter the RTP/RTCP port number.

MTU Size

Enter the MTU size.

LAN **SNMP**

SNMP Mode

Allows you to select whether the Simple Network Management Protocol (SNMP) agent is enabled.

On: Enables the SNMP agent.

Off: Disables the SNMP agent.

Trap Destination

Enter the address of the trap destination SNMP manager.

Community

Enter the community name managed by the SNMP manager (up to 24 characters). By default, “public” is entered.

Description

Enter the description of this terminal. By default, “Videoconference Device” is entered and can not be changed.

Location

Enter the location where this terminal is installed (up to 30 characters).

Contact

Enter information about the terminal administrator (up to 30 characters).

QoS Setup Menu

Specifies the functions for providing optimum consistent communication.

Notes

- When “Lip Sync” is set to “Off” in the Audio setup menu, you cannot change the setting for “Adaptive Rate Control (ARC)”, “Packet Resend Request (ARQ)” or “Forward Error Correction (FEC)”.
- When “Adaptive Rate Control (ARC)”, “Packet Resend Request (ARQ)” or “Forward Error Correction (FEC)” is set to “On”, you cannot set “Lip Sync” to “Off” in the Audio setup menu.

QoS1

Basic Setup

Adaptive Rate Control (ARC)

Allows you to select whether to always optimize the LAN bandwidth.

On: Always optimizes the LAN bandwidth.

Off: Does not optimize the LAN bandwidth.

Auto Bandwidth Detection

Allows you to select whether you use the Auto Bandwidth Detection feature.

On: Enables the Auto Bandwidth Detection feature.

Off: Disables the Auto Bandwidth Detection feature.

TCP Port Number

Enter the fixed TCP port number.

UDP Port Number

Enter the fixed UDP port number.

For details on the port numbers used on the system, see “List of Port Numbers Used on the PCS-XL55” on page 241.

Packet Resend Request (ARQ)

Allows you to select whether to request packet to be resent when packet losses occur during communication.

On: Requests packets to be resent.

Off: Does not request packets to be resent.

ARQ Buffering Time

Set the buffering time used for “Packet Resend Request”.

You can select from among “300ms”, “150ms”, “80ms”, “Auto” and “Custom”.

When “Custom” is selected, you can specify any buffering time.

ARQ Buffering Time

Enter the buffering time (50 ms to 999 ms) when you select “Custom” in “ARQ Buffering Time”.

Forward Error Correction (FEC)

Allows you to select whether received packets are identified with an error correction mark.

On: Identifies with an error correction mark.

Off: Not identify with an error correction mark.

FEC Redundancy

Allows you to set redundancy of the packet used for the Forward Error Correction (FEC).

You can select from among “8”, “4”, “2” and “Auto”. When you select “8”, “4” and “2”, the communication bit rate may be different from the specified value.

Audio Duplex Transmission

Allows you to select whether to automatically transmit audio in double when audio communication is interrupted depending on a network status.

On: Enables the Audio Duplex Transmission feature.

Off: Disables the Audio Duplex Transmission feature.

QoS QoS2

Re-Order/Shaping

Re-Order

Allows you to select whether to correct re-order that may cause packet loss (invalid order of arrival in the packet). Correcting re-order enables smoother picture and sound.

On: Corrects re-order.

Off: Does not correct re-order.

Re-Order Buffer

Allows you to select re-order buffer.

You can select from among “Auto”, “1”, “2” and “Custom”.

Re-Order Buffer Rate

Enter the re-order buffer rate. You can enter the value between 1 and 5.

Shaping

Allows you to select whether to use shaping, which adjusts the IP packet transfer rate.

On: Uses shaping.

Off: Does not use shaping.

TOS Setup Menu

TOS TOS

TOS

TOS Data Type

Allows you to select the type of data for which you configure the TOS (Type of Service) field.

Video: Configure the TOS field for video data.

Audio: Configure the TOS field for audio data.

Data: Configure the TOS field for camera control signals, etc.

Presentation: Configure the TOS field for the RGB presentation data.

TOS

Allows you to select how to define the TOS (Type of Service) field of the data selected in “TOS Data Type”.

Off: Does not define the TOS field.

IP Precedence: Defines the TOS field as IP Precedence.

DSCP: Defines the TOS field as the Differentiated Services Code Point (DSCP). Enter the value between 0 and 63.

Precedence

Enter the IP Precedence value between 0 and 7.

Low Delay

Allows you to select whether to specify the Low Delay bit of the TOS field.

On: Specifies the Low Delay bit of the TOS field.

Off: Does not specify the Low Delay bit of the TOS field.

High Throughput

Allows you to select whether to specify the High Throughput bit of the TOS field.

On: Specifies the High Throughput bit of the TOS field.

Off: Does not specify the High Throughput bit of the TOS field.

High Reliability

Allows you to select whether to specify the High Reliability bit of the TOS field.

On: Specifies the High Reliability bit of the TOS field.

Off: Does not specify the High Reliability bit of the TOS field.

Minimum Cost

Allows you to select whether to specify the Minimum Cost bit of the TOS field.

On: Specifies the Minimum Cost bit of the TOS field.

Off: Does not specify the Minimum Cost bit of the TOS field.

DSCP

Enter the DSCP value. This item only appears when “TOS” is set to “DSCP”.

SIP Setup Menu

The SIP setup menu is used to connect with an IP phone, etc. using the SIP (Session Initiation Protocol).



Basic Setup

SIP Server Mode

Allows you to select whether you use a SIP server or not.

On: Enables use of the SIP server.

Off: Disables use of the SIP server.

Transport Protocol

Allows you to select the protocol to be used for SIP.

TCP: Uses TCP (Transmission Control Protocol).

UDP: Uses UDP (User Datagram Protocol). This is the factory default setting.

Port Number

Enter the port number to be used for SIP.

SIP Domain

Enter the SIP domain name.

Registered User Name

Enter the user name for the terminal to be registered to the SIP server (up to 39 characters).

Password

Set the password for the terminal to be registered to the SIP server (up to 39 characters).

SIP Server Address

Enter the address of the SIP server.

SIP Server Port

Enter the port number used for communication with the SIP server.

ISDN Setup Menu

The ISDN setup menu is used to set up ISDN lines.



Basic Setup

Country/Region

Allows you to select the country or region where you are using the Communication System.

Protocol

Allows you to select the protocol of the ISDN lines to be used. You can select National ISDN, Japan (NTT), Euro ISDN, Euro ISDN (France), 5ESS (P-P), or DMS-100, depending on the interface that you are using.

For customers in the USA and Canada, see “SPID Settings for Customers in the USA and Canada” on page 72.

ISDN2

Telephone

Number

Enter the area code and local number in the text boxes corresponding to the port numbers on the ISDN unit.

The text boxes correspond to the port numbers on the ISDN unit in the following way.

A1: Port 1 on the ISDN unit.

A2: Port 1 on the ISDN unit.

B1: Port 2 on the ISDN unit.

B2: Port 2 on the ISDN unit.

C1: Port 3 on the ISDN unit.

C2: Port 3 on the ISDN unit.

Area Code

Enter the area code of the ISDN line to be used. Do not enter the first 0 of the area code.

Local Number

Enter the line number (local number) of the ISDN line to be used.

Notes

- When you select an empty field and then press the ENTER button of the Remote Commander, the setting of the previous field is copied into the selected field.
- When using the PCSA-B768S ISDN Unit, selecting the ISDN3 button displays the D1 to F2 text boxes. Fill in the D1 to F2 text boxes according to the lines that you are using.

ISDN4

Sub Address

The A1 to C2 (or A1 to F2) fields appear.

Sub Address

Enter sub-addresses when registering them. Sub-addresses can only be composed of numbers.

ISDN5

SPID

The SPID (Service Profile Identifier) pages are used only for customers in the USA and Canada.

For details, see “SPID Settings for Customers in the USA and Canada” on page 72.

SPID

The A1 to C2 (or A1 to F2) fields appear. Enter SPID (Service Profile Identifier).

Auto SPID

When you select “Auto SPID”, you can automatically set up the Area Code and Local Number on the Telephone Number page and SPID items.

SPID Settings for Customers in the USA and Canada

If you connect to an ISDN switch type, configuration of SPID (Service Profile Identifier) is required.

If “Auto SPID” is not available in your area, set up SPID manually using the ISDN setup menu.

- 1 Open the Basic Setup page of the ISDN setup menu.
- 2 Enter the country code in the Country/Region Code text box depending on the network switch type you are using.

AT&T 5ESS (National ISDN), NTI DMS-100 (National ISDN): Enter “1”.

AT&T 5ESS (Point-to-Point Custom ISDN): Enter “1*12”.

NTI DMS-100 (Custom ISDN): Enter “1*11”.

- 3** Open the Telephone Number page to enter the LDN (Local Directory Number) in the Local Number text boxes.

When you use the AT&T 5ESS (Point-to-Point Custom ISDN) switch type

Enter the same LDNs in the A1 and A2 (B1 and B2, C1 and C2, depending on the number of lines you use) text boxes.

When you use the NTI DMS-100 (National ISDN) or NTI DMS-100 (Custom ISDN) switch type

Enter the different LDNs in the A1 and A2 (B1 and B2, C1 and C2, depending on the number of lines you use) text boxes. These switch types are given a separate number for each channel.

When you use the AT&T 5ESS (National ISDN) switch type

You may enter the same or different numbers in two channels.

- 4** Open the SPID page (ID page) to enter the SPID.

The SPID is generally comprised of 12 digits, including a 7 digit LDN (Local Directory Number). Be sure to enter the different SPID number in each of the A1 and A2 (B1 and B2, C1 and C2, depending on the number of lines you use) text boxes if you have entered the separate LDNs in the Local Number text boxes for each channel in step 3.

For the AT&T 5ESS (National ISDN) switch type

Enter the SPID in the A1 text box only.

For the NTI DMS-100 (National ISDN), NTI DMS-100 (Custom ISDN), AT&T 5ESS (National ISDN) switch type

Enter the different SPID numbers in the A1 and A2 text boxes.

For the AT&T 5ESS (Point-to-Point Custom ISDN) switch type

You do not need to set up the SPID, then no entry in the A1 and A2 (B1 and B2, C1 and C2, depending on the number of lines you use) is required.

- 5** After the settings are completed, select “Save”, then press the ENTER button.

Annotation Setup Menu

The Annotation setup menu is used for the annotation function allowing you to write letters or graphics on the screen using a pen tablet.



Enable

Allows you to select whether the annotation function is enabled.

On: Enables the annotation function.

Off: Disables the annotation function.

Color

Allows you to select the color of the letters or graphics written on the screen with a pen tablet.

You can select from among “Black”, “Red”, “Blue”, “Green”, “Yellow”, “Orange”, “Purple” and “White”.

Line Density

Allows you to select the density of the line written on the screen with a pen tablet.

You can select from among “Thick”, “Medium” and “Thin”.

Camera Setup Menu



Camera

Camera

General Setup Menu



General1

Device Setup

Terminal Name

Input the local terminal name transmitted to a remote party (up to 30 characters).

Standby Mode

Allows you to select whether the Communication System enters standby mode if it is idle for a specified period of time.

On: Allows the System to go on standby.

Off: Does not allow the System to go on standby.

Standby Time

Specify the time the system must remain idle before entering the standby mode. This time can be set between 1 and 99 minutes.

For details on the standby mode, see “Standby Mode Function” on page 36.

Last Number Registration

Allows you to select whether to register the remote party in the Phone Book after the communication ends.

Off: The registration of the remote party does not take place.

On: If the remote party is not registered in the Phone Book, the message “Register this participant in the list?” appears on the monitor screen when communication ends. When you select “OK”, the List Edit menu opens.

Control by Far End

When “Far End Camera Control” is set to “On” in the Communication setup menu, you can temporarily reject the camera control command transmitted by the remote party.

On: Accepts the camera control command.

Off: Rejects the camera control command.

Language

Allows you to select the menu and display language used by the system. You can select from the following languages: English, French, German, Japanese, Spanish, Italian, Simplified Chinese, Portuguese, Traditional Chinese, Korean, Dutch, Danish, Swedish, Finnish, Polish, Russian, Arabic, Thai, Norwegian, Turkish, Welsh, Czech and Hungarian.

Note

Menu displays may be in English for some languages.



General2

Clock Set

NTP

Allows you to select whether to obtain clock information from the server with NTP.

On: Obtains clock information from the server.

Off: Does not obtain clock information from the server.

Primary NTP Server

Enter the address of the primary NTP server from which the clock information is obtained.

Secondary NTP Server

Enter the address of the secondary NTP server from which the clock information is obtained.

Time Zone

Allows you to select the country or region where you are using the Communication System.

Clock Display Pattern

Allows you to select the display pattern of the clock.

You can select from among “Year/Month/Day”, “Month/Day/Year”, “Day/Month/Year”, “Year-Month-Day” and “Day.Month.Year”.

Date

Enter the current date (year/month/day).

Time

Set the current clock.

Time Update

Selecting “Execute” and pressing the ENTER button on the Remote Commander updates the clock setting when “NTP” is set to “On”.



General3

Menu Screens

Allows you to select whether to display the items of the Tools and Setup menus.

Display Time in Communication

Off: Displays neither the elapsed nor current time during communication.

Time Display: Displays the elapsed time during communication.

Current Time: Displays the current time during communication.

Display Terminal Name

Off: Does not display the connected terminal names.

Always show: Always displays the connected terminal names.

Show temporarily: Displays the connected terminal names for a brief moment.

Guide

On: Displays the instruction that guides the operation.

Off: Does not display the instructions.

Display Indicator

On: Displays the indicators such as “Memory Stick” and tablet.

Off: Does not display the indicators.

Communication Mode Display

On: Displays the communication mode when the system is connected to the remote site.

Off: Does not display the communication mode when the system is connected to the remote site.

Display On-Screen Keyboard

On: Displays the on-screen keyboard.

Off: Does not display the on-screen keyboard.

For details on the on-screen keyboard, see “Entering Characters Using the On-Screen Keyboard” on page 52.

Menu Transparency

Allows you to select the degree of transparency of the superimposed menu display over the background picture. You can select from among “High”, “Medium” and “Low”.



General4

Function Keys in Communication

Allows you to switch the picture with one press of a button on the Remote Commander.

You can set the function to be assigned to each of the F1 to F4 (function) buttons.

Note

You cannot set “Function Keys in Communication” during communication. Set this item before starting communication.

F1

Allows you to select the video input switched by pressing the F1 button on the Remote Commander. You can select from among “Far/Near”, “Camera”, “RGB”, and “No Operation”.

This item is preset to “Far/Near” at the factory. This setting allows you to switch the cameras to be controlled between the local and remote sites during communication by pressing the F1 button on the Remote Commander.

Note

Even if “F1” is set to any option other than “Far/Near”, “F1” is fixed to “Far/Near” while the Video Input or Layout menu is displayed on the screen. In some other cases, the function of the F1 to F4 buttons may be fixed regardless of the setting for practical convenience, in which case the functions of the button are shown in the instruction display.

F2

Allows you to select the video input switched by pressing the F2 button on the Remote Commander. You can select from among “Camera”, “RGB”, and “No Operation”.

F3

Allows you to select the video input switched by pressing the F3 button on the Remote Commander. You can select from among “Camera”, “RGB”, “Zoom (RGB)” and “No Operation”.
When “Zoom (RGB)” is selected, a 4:3 aspect ratio picture will be enlarged.

F4

Allows you to select the video input switched by pressing the F4 button on the Remote Commander. You can select from among “Camera”, “RGB”, and “No Operation”.

Home Menu Setup Menu**Home Menu1**

Allows you to select the items that show or hide in/from the Home menu.

Note

Some items may not be set during communication.

Clock Display

On: Allows display of the current time in the Home menu.

Off: Does not display the current time.

Local Terminal Name

On: Displays the local terminal name in the Home menu.

Off: Does not display the local terminal name.

Number Display

Allows you to select the identification of the local system, such as the IP address and user name, to be displayed in the Home menu.

SIP:User Name: Displays the user name registered in the SIP server.

SIP:Address: Displays the SIP address.

GK:User Alias: Displays the user name registered in the gatekeeper when you use the gatekeeper.

GK:User Number: Displays the user number registered in the gatekeeper when you use the gatekeeper.

NAT:Address: Displays the NAT address when you connect the system to a network using NAT.

IP: Address: Displays the IP address.

No display: Does not display any identification, such as the IP and user name, for the system.

Terminal Status

On: Displays the local terminal status in the Home menu.

Off: Does not display the local terminal status.

Warning Messages

On: Displays a warning message in the Home menu when an abnormality occurs.

Off: Does not display a warning message.

**Home Menu2**

Allows you to select whether to display the menu buttons in the Home menu.

Connect Button Display

Select the buttons for connection to be displayed in the Home menu.

Simple: Displays “Connect” button only.

Individual: Selects whether to display “Phone Book”, “History” or “Detailed Dial” depending on the setting of each button.

Off: Does not display the buttons for connection.

Phone Book Button

On: Displays “Phone Book”.

Off: Does not display “Phone Book”.

History Button

On: Displays “History”.

Off: Does not display “History”.

Detailed Dial Button

On: Displays “Detailed Dial”.

Off: Does not display “Detailed Dial”.

Camera Button

On: Displays “Camera”.

Off: Does not display “Camera”.

Tools Button

Off: Does not display “Tools”.

On: Displays “Tools”.

One-Touch Dial

On: Displays the one-touch dial buttons.

Off: Does not display the one-touch dial buttons.

Direct Dial

Off: Does not display “Dial” and the text box for direct dialing.

On: Displays “Dial” and the text box for direct dialing.

Home Menu3 Home Menu3

Allows you to select whether to display the indicators (status information) in the Home menu.

Video Input Display

On: Displays the current video input name.

Off: Does not display the current video input name.

Audio Input Display

On: Displays the current audio input.

Off: Does not display the current audio input.

Audio Level Meter

On: Displays the current audio input level.

Off: Does not display the current audio input level.

Volume

On: Displays the volume meter for a certain duration when the volume is adjusted.

Off: Does not display the volume meter.

LAN Status

On: Displays the current status of LAN connection.

Off: Does not display the current status of LAN connection.

ISDN Status

On: Displays the currently used ISDN unit port.

Off: Does not display the currently used ISDN unit port.

Administrator Setup Menu

The Administrator setup menu is used for the system administrators.

Administrator1 Password

By registering the password in this menu, you can restrict user access from the system or the Web page to the setup menus and Phone Books, and prevent their modification.

Note

If a password is not enabled, anyone will be able to access the system using the respective user name. Be sure to configure all of the passwords to prevent unauthorized third parties on the network from accessing the system.

For details on when each password is used for authorization in the Web page, see “Chapter 8: Web Control Function”.

Administrator Password

Use up to 8 alphanumeric characters and symbols to register the password used by the system administrator.

When you register an Administrator Password, a password prompt will appear when you access the Administrator setup menu. In addition, the Administrator Password can be used as the main password

if multiple passwords are registered. For example, if the Phone Book Modification Password, Save Settings Password, and Administrator Password are registered, the Administrator Password can be used to modify Phone Books and settings.

Notes

- After you enter the Administrator Password to modify settings or Phone Books, unless you switch to a different screen from the setup menu or Phone Book screen, modification will be enabled without password reentry. In addition, modification will be enabled without password reentry for about 2 minutes after returning to the Home menu from the setup menu or Phone Book. The same applies when you access the Administrator setup menu.
- Registering only the Administrator Password will not enable password protection for settings and Phone Book modification. Always register the Phone Book Modification Password and the Save Settings Password in addition to the Administrator Password.
- Be aware that registering other passwords but leaving the Administrator Password blank allows for modification and connection from the Web page without password input.
- Make sure to write down the Administrator Password. If you should forget the Administrator Password, consult your Sony dealer. In this case, the memory of the Communication System is initialized before repair, and the data in the Phone Book and History lists, as well as various setting data, are erased.

Phone Book Modification Password

Use up to 8 alphanumeric characters and symbols to register the password used for Phone Book modifications.

Note

After you enter the Phone Book Modification Password to modify Phone Books, unless you switch to a different screen from the Phone Book, modification will be enabled without password reentry. In addition, modification will be enabled without password reentry for about 2 minutes after returning to the Home menu from the Phone Book.

Save Settings Password

Use up to 8 alphanumeric characters and symbols to register the password used for saving settings.

Note

After you enter the Save Settings Password to modify settings, unless you switch to a different screen from the setup menu, modification will be enabled without password reentry. In addition, modification will be enabled without password reentry for about 2 minutes after returning to the Home menu from the setup menu.

Remote Access Password

Use up to 8 alphanumeric characters and symbols to register the password used for accessing the Web page.

Streaming Broadcast Password

Use up to 8 alphanumeric characters and symbols to register the password used when receiving and viewing video and audio streams from PCS terminals on the Web page.

Administrator2

Setup Password1

Allows you to select whether to require “Save Settings Password” when saving each setting.

Line Interface

Enabled: Requires “Save Settings Password” when saving the Line Interface settings.

Disabled: Does not require the password when saving the Line Interface settings.

Dial

Enabled: Requires “Save Settings Password” when saving the Dial setup settings.

Disabled: Does not require the password when saving the Dial setup settings.

Answer

Enabled: Requires “Save Settings Password” when saving the Answer setup settings.

Disabled: Does not require the password when saving the Answer setup settings.

Multipoint

Enabled: Requires “Save Settings Password” when saving the Multipoint settings.

Disabled: Does not require the password when saving the Multipoint settings.

IP Mode

Enabled: Requires “Save Settings Password” when saving the IP Mode settings.

Disabled: Does not require the password when saving the IP Mode settings.

SIP Mode

Enabled: Requires “Save Settings Password” when saving the SIP Mode settings.

Disabled: Does not require the password when saving the SIP Mode settings.

ISDN Mode

Enabled: Requires “Save Settings Password” when saving the ISDN Mode settings.

Disabled: Does not require the password when saving the ISDN Mode settings.

Administrator3 Setup Password2

Audio

Enabled: Requires “Save Settings Password” when saving the Audio setup settings.

Disabled: Does not require the password when saving the Audio setup settings.

Video

Enabled: Requires “Save Settings Password” when saving the Video setup settings.

Disabled: Does not require the password when saving the Video setup settings.

LAN

Enabled: Requires “Save Settings Password” when saving the LAN setup settings.

Disabled: Does not require the password when saving the LAN setup settings.

QoS

Enabled: Requires “Save Settings Password” when saving the QoS setup settings.

Disabled: Does not require the password when saving the QoS setup settings.

TOS

Enabled: Requires “Save Settings Password” when saving the TOS setup settings.

Disabled: Does not require the password when saving the TOS setup settings.

SIP

Enabled: Requires “Save Settings Password” when saving the SIP setup settings.

Disabled: Does not require the password when saving the SIP setup settings.

ISDN

Enabled: Requires “Save Settings Password” when saving the ISDN setup settings.

Disabled: Does not require the password when saving the ISDN setup settings.

Administrator4 Setup Password3

General

Enabled: Requires “Save Settings Password” when saving the General setup settings.

Disabled: Does not require the password when saving the General setup settings.

Home Menu

Enabled: Requires “Save Settings Password” when saving the Home Menu setup settings.

Disabled: Does not require the password when saving the Home Menu setup settings.

Administrator

Enabled: Requires “Save Settings Password” when saving the Administrator setup settings.

Disabled: Does not require the password when saving the Administrator setup settings.

Annotation

Enabled: Requires “Save Settings Password” when saving the Annotation setup settings.

Disabled: Does not require the password when saving the Annotation setup settings.

Camera

Enabled: Requires “Save Settings Password” when saving the Camera setup settings.

Disabled: Does not require the password when saving the Camera setup settings.

Encryption

Enabled: Requires “Save Settings Password” when saving the Encryption setup settings.

Disabled: Does not require the password when saving the Encryption setup settings.

Shared Phone Book

Enabled: Requires “Save Settings Password” when saving the Shared Phone Book settings.

Disabled: Does not require the password when saving the Shared Phone Book settings.

 Administrator5

Streaming/

Recording

Streaming

Select whether to enable the streaming broadcast.

Enabled: Permits the streaming broadcast.

Disabled: Does not permit the streaming broadcast of a videoconference.

Recording

Select whether to enable the recording of video and audio to a “Memory Stick.”

Enabled: Permits the recording.

Disabled: Does not permit the recording.

Video

Select a bit rate for streaming and recording video.

Off: Disables the streaming and recording of video.

64Kbps: Streams and records video at 64 Kbps.

128Kbps: Streams and records video at 128 Kbps.

384Kbps: Streams and records video at 384 Kbps.

512Kbps: Streams and records video at 512 Kbps.

Note

When “Off” is selected, only audio can be streamed and recorded.

Multicast Address

Enter the multicast address for streaming broadcasts.

Note

You can enter the unicast address in this menu. If you set the unicast address, enter two or more different numbers in “Audio Port Number” and “Video Port Number” for streaming broadcasts.

Audio Port Number

Enter the audio port number for streaming broadcasts.

Video Port Number

Enter the video port number for streaming broadcasts.

HOP

Enter a number from 0 to 255 as the HOP for streaming broadcasts.

 Administrator6

Access Permit

Note

Depending on the operating environment, unauthorized third parties on the network may be able to access the system. When you set “Web Monitor”, “Web Access”, “Telnet Access”, or “SSH Access” to “On” or “Enabled”, the following confirmation screen will appear.

When the functions that allow external access to the unit are enabled, the unit may be accessed by unauthorized third parties on the network. Therefore, be sure to configure all of the passwords in the Password page of the Administrator setup menu in such cases.

Accept

Cancel

To confirm the change in the setting, select “Accept” and configure all of the passwords on the Password page (page 77) of the Administrator setup menu. The setting will not be changed if you select “Cancel”.

Web Monitor

Allows you to permit the monitoring communication status through a Web browser (automatic update of JPEG images).

On: Permits monitoring with a Web browser.

Off: Does not permit monitoring with a Web browser.

Web Access

Select whether to permit access to the Communication System via a Web browser.

Enabled: Permits access via a Web browser.

Disabled: Prohibits access via a Web browser.

Telnet Access

Select whether to permit access to the Communication System via Telnet.

Enabled: Permits access via Telnet.

Disabled: Prohibits access via Telnet.

SSH Access

Allows you to select whether to permit access to the Communication System via SSH (Secure Shell).

Enabled: Permits access via SSH.

Disabled: Prohibits access via SSH

Administrator7 Other

Use History

Select whether to display the history lists in order to use for dialing, etc.

On: Displays the history lists.

Off: Does not display the history lists.

Save Setup

Saves the data for each setting to a “Memory Stick”. The data for each setting saved on the “Memory Stick” is overwritten.

Note

Phone Book and History data are not saved.

Load Setup

Loads the data for each setting from a “Memory Stick”. The data for each setting saved on the System is overwritten.

Note

When saving and loading settings, make sure that the version of the system from which the data was originally saved is the same as the version of the local system. If the versions differ, the data may not be properly recognized.

AMX Device Discovery

Select whether to export AMX Device Discovery information onto the network.

Off: Disables this function.

On: Enables this function.

When the AMX system is connected to the Communication System via serial connection, AMX Device Discovery information is output via that serial connection.

AMX systems are external control devices that can be used to control the Communication System. When the AMX system receives Device Discovery

information from the Communication System, the System automatically falls under the control of the AMX system.

HOP

Enter a number from 0 to 255 as the HOP Display Terminal Name.

Auto Restore

Allows you to select whether to automatically turn on the Communication System if an power interruption occurs and is then restored.

On: Enables the Auto Restore function.

Off: Disables the Auto Restore function.

Internet Protocol

IPv4: Uses the internet protocol version 4 (IPv4) that is commonly used.

IPv6: Uses the next-generation internet protocol version 6 (IPv6).

IPv4/IPv6: Uses both IPv4 and IPv6.

Note

When “Internet Protocol” is set to “IPv6” or “IPv4/IPv6”, some of the functions of this system are restricted, and some of the Administrator setup menus are not displayed.

For details, see “Restrictions on the Use of IPv6” on page 87.

Administrator8 Phone Book

Save Phone Book

Allows you to save the data in the Phone Book on a “Memory Stick”. The data already stored on the “Memory Stick” is overwritten.

Load Phone Book

Allows you to load the data in the Phone Book from a “Memory Stick.” The data already stored in the Phone Book is overwritten.

Note

When loading Phone Book data, make sure that the version of the system from which the data was originally saved is the same as the version of the local system. If the versions differ, the data may not be properly recognized.

Clear Phone Book

Allows you to delete a Phone Book on the system.

Auto Dialing

Allows you to select whether to automatically dial a specified remote party in the Private Phone Book created in a “Memory Stick”, when the “Memory Stick” is inserted.

On: Enables the Auto Dialing function.

Off: Disables the Auto Dialing function.

For details, see “To dial a specified remote party in a Private Phone Book automatically” on page 120.

Create Private Phone Book

Allows you to create an empty folder and file for a Private Phone Book on a “Memory Stick” inserted into the system.

For details, see “Creating a Private Phone Book” on page 119.

Delete Private Phone Book

Allows you to delete the Private Phone Book on a “Memory Stick” inserted into the system.

Copy to Private Phone Book

Allows you to copy the entire contents of the Phone Book to a Private Phone Book on a “Memory Stick” inserted into the system.

Encryption Setup Menu

The Encryption setup menu is used to connect to a remote party using the encryption function.

The encryption function allows you to hold a strictly confidential connection.

For details on an encrypted connection, see Chapter 5.

Encryption

Encryption

Encryption Mode

Select whether you use the encryption feature.

Off: Disables use of the encryption feature.

Connect Priority: Connects with the encryption feature to a remote party with standard encrypted connection enabled. Connects without the encryption feature to a remote party with standard encrypted connection disabled or with the encryption feature set to off.

Encrypt Priority: Connects only to a remote party with standard encrypted connection enabled.

Shared Phone Book Setup Menu

This menu is used to configure the settings when using the Shared Phone Book located on the server.

For details on the Shared Phone Book, see “Using the Shared Phone Book” on page 121.

Shared Phone Book

Shared Phone Book

Book

SPB Mode

Selects whether to use the server managing the Shared Phone Book.

On: Enables use of the server managing the Shared Phone Book.

Off: Disables use of the server managing the Shared Phone Book.

SPB Server Address

Enter the IP address for the server managing the Shared Phone Book.

SPB Server Password

Enter the password for the server managing the Shared Phone Book.

Displaying the Machine Status

The Machine Status menu allows display of the versions, communication mode, line connection quality, etc. of the Communication System and the connected equipment.

Displaying the Machine Status Menu

- 1 Press the TOOLS button on the Remote Commander or use the **↑**, **↓**, **←** or **→** button to select “Tools”, then press the ENTER button.

The Tools menu appears,

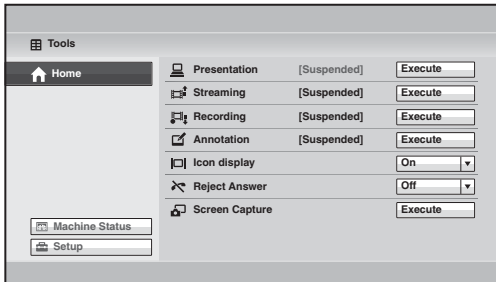

- 2 Use the **↑**, **↓**, **←** or **→** button on the Remote Commander to select “Machine Status”, then press the ENTER button.

The Machine Status menu appears.

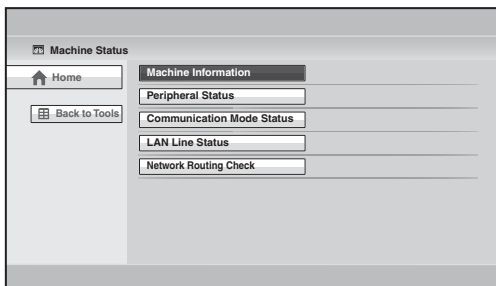

Information screens enabled for display by the Machine Status menu

Machine Information (see page 85)

Peripheral Status (see page 85)

Communication Mode Status (see page 85)

LAN Line Status (see page 86)

Network Routing Check (see page 86)

- 3 Use the **↑**, **↓**, **←** or **→** button on the Remote Commander to select the information to be displayed, then press the ENTER button.
The selected display appears.

Machine Information

The Machine Information menu shows the versions of the HD Visual Communication System and the connected equipment for exclusive use, installed software versions, etc.

Host Version

Displays the software version of the HD Visual Communication System.

Software Option

Displays the optional software installed.

None: No software is installed.

Presentation: The PCSA-DSG80 HD Data Solution software is installed.

Multipoint: The Communication System is equipped with the HD MCU software preinstalled.

Option I/F

Displays the optional connected equipment.

None: No optional equipment is connected.

ISDN (B768): The PCSA-B768S ISDN Unit is connected.

ISDN (B384): The PCSA-B384S ISDN Unit is connected.

Tablet: Pen tablet (Bamboo small CTH-470/K0 manufactured by Wacom Co., Ltd.) is connected.

Host Name

Displays the host name.

IP Address

Displays the IP address for LAN.

Note

When “Internet Protocol” is set to “IPv4/IPv6” in the Administrator setup menu, both IPv4 and IPv6 IP addresses are displayed.

MAC Address

Displays the MAC address for LAN.

Serial Number

Displays the serial number.

Machine version

Selecting “Next” in the Machine Information menu shows the codec version, etc.

Peripheral Status

Video Input

Displays the input video name.

Audio Input (MIC)

Displays microphone input name.

Audio Input (AUX)

Displays the external audio input name.

Video Output

Displays the video output size and the 50 Hz/60 Hz setting of “Frequency”.

Audio Output

Displays the audio output equipped with this system.

LAN Mode

Displays the LAN Mode for LAN.

Gatekeeper

Displays the status of registration to gatekeeper with the following messages: Gatekeeper Requested, Gatekeeper Confirmed, Gatekeeper Reject, Registration Requested, Registration Confirmed, Registration Failed, Registration Rejected, Registration Timeout, Unregistration Requested and Unregistration Confirmed.

Communication Mode Status

The Communication Mode Status menu shows the status of current communication when communication is in progress, and the status of previous communications when communication is not in progress. The ISDN Line Status, LAN Line Status or LAN Connection Status will also be displayed depending on the line interface used.

Communication Mode Status

The current communication status will be displayed. When two points are connected to the system, selecting “Next” in the lower part of the page displays the next page. For the items described with both “(Encode)” and “(Decode)”, the descriptions under “(Encode)” show the setting status of the local system and those under “(Decode)” show the status of the receiving.

Far End Terminal Name

Displays the terminal name of a remote party.

Remote Address

Displays the address of a remote party.

Audio Mode

Displays the current audio encoding format.

Video Mode

Displays the current video encoding format. “H.264 HP” appears during H.264 High Profile communication, and “H.264” appears during H.264 Baseline Profile communication. However, these do not appear in 1080 Mode.

Note

The audio encoding and video encoding formats used for communication with a remote party may differ from the settings in this menu, depending on the status of the system on the remote site.

Frame Rate

Displays the maximum frame rate of motion pictures.

Rate

Displays in real time the number of connected lines and their transfer rates.

Line I/F

Displays the line interface being used.

Camera Control

Displays whether the unit is ready to operate both cameras.

H239

Displays whether the unit is ready to use the H.239 presentation mode.

Check Code

Displays the encryption check code.

LAN Line Status

The LAN line status will be displayed on one page for each point connected to the system. The connected point is shown at the upper left corner of each page. Selecting “Next” in the lower part of the page displays the next page.

Bit rate - Encode

Displays by category (audio, video and H.239 (presentation)) the transfer rates for sending data.

Bit rate - Decode

Displays by category (audio, video and H.239 (presentation)) the transfer rates for receiving data.

Number of lost packets

Displays by category (audio, video and H.239 (presentation)) the number of packets lost during transfer on the network.

Number of recovered packets

Displays by category (audio, video and H.239 (presentation)) the number of lost packets that were recovered with the system’s QoS function.

Number of received packets

Displays by category (audio, video and H.239 (presentation)) the number of packets received during communication.

Network Routing Check

The Network Routing Check menu is used to check the network routing, and it shows the checking results.

You can start the network routing check by selecting “Start Measurement” in the lower part of the menu.



For details, see “About the Network Routing Check” on page 96.

IP address of remote site

Enter the IP address of the remote terminal you want to check.

Line I/F

LAN: Select to perform the routing check for the network connected to the  connector.

Gateway

Displays the results of check for the default gateway.

ping

Displays the results of check for reachability, packet loss, RTT (Round-Trip Time) and H.323 (H.323 communication availability).

traceroute

Displays the results of check for HOP (number of routers passed through to reach the remote site) and total RTT.

Start Measurement

Select this button to start a network routing check.

Previous

Select this button to restore the Machine Status menu.

Restrictions on the Use of IPv6

The functions of the system are restricted as follows when using the IPv6 Internet Protocol or both the IPv4 and IPv6 Internet Protocols.

Unusable functions with IPv6

- SNMP Mode*
- NTP
- Shared Phone Book*
- TOS*
- Network Routing Check*
- AMX Device Discovery*
- PPPoE
- Streaming
- NAT
- SIP

* Usable with IPv4 when using both IPv4 and IPv6.

Setting Up the Network Configurations

This section describes how to set up the network configurations for use with various networks.

For details on the LAN setup menu, see “LAN Setup Menu” (page 66).

For details on configurations, consult with the system administrator.

LAN Connection via DHCP

Configuration example

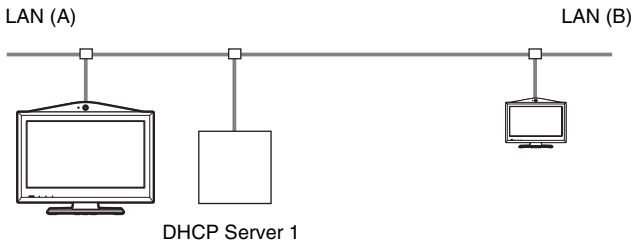

Set “DHCP Mode” to “Auto” under the Basic Setup page in the LAN setup menu.

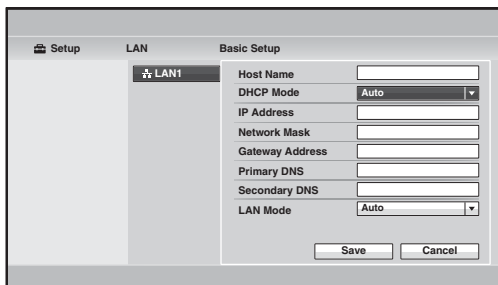

The setting has been configured properly if the IP address appears in the Home menu.

To connect to a remote party

Select “IP” under “Line I/F”, enter the remote party’s IP address, and dial.

LAN Connection through a Router

Configuration example

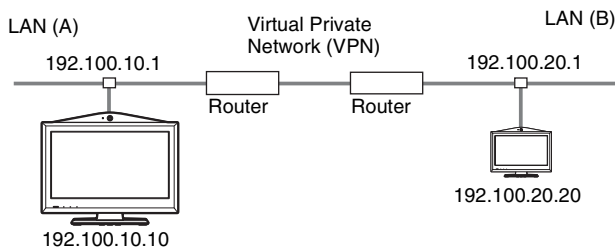

Enter a name in “Host Name” under the Basic Setup page in the LAN setup menu, and enter the appropriate values for “IP Address”, “Network Mask”, and “Gateway Address”.

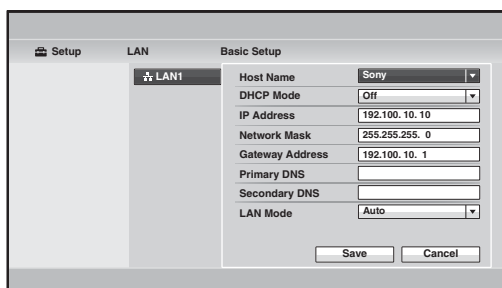

The setting has been configured properly if the correct IP address appears in the Home menu.

To connect to a remote party

Select “IP” under “Line I/F”, enter the remote party’s IP address, and dial.

LAN Connection through a Gatekeeper

Configuration example

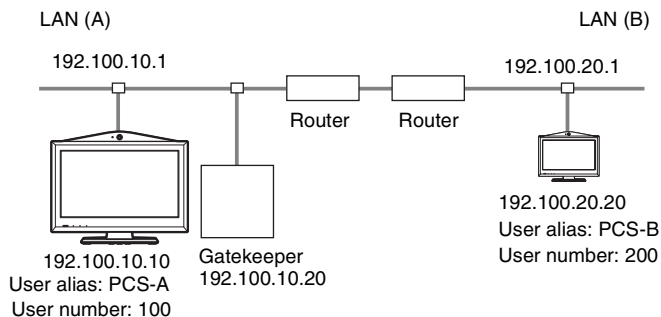

- 1 Enter a name in “Host Name” under the Basic Setup page in the LAN setup menu, and enter the appropriate values for “IP Address”, “Network Mask”, and “Gateway Address”.

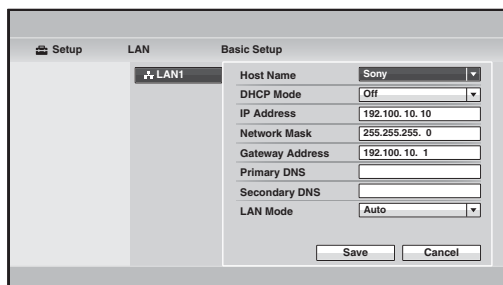

- 2 Set “Gatekeeper Mode” to “On” under the Gatekeeper page of the LAN setup menu, and enter the appropriate values for “Gatekeeper Address”, “User Alias”, and “User Number”.

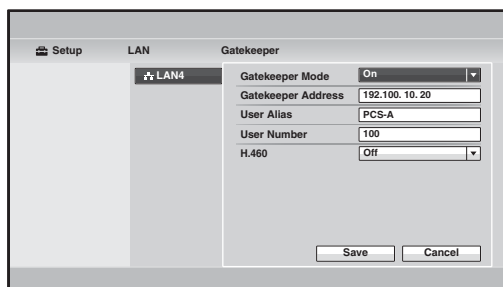

The IP address registered in the Home menu.



To connect to a remote party

Select “IP” under “Line I/F”, enter the user name or user number set by the remote party, and dial.

LAN Connection through NAT

Connection using NAT allows one IP address to be shared by several computers on the same LAN. This section describes how to set up visual communication in NAT and global IP environments.

Configuration example

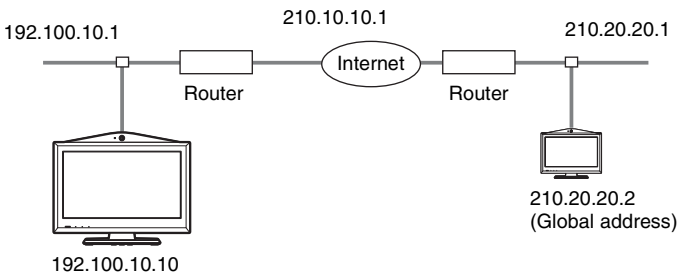

- 1 Enter a name in “Host Name” under the Basic Setup page in the LAN setup menu, and enter the appropriate values for “IP Address”, “Network Mask”, and “Gateway Address”.

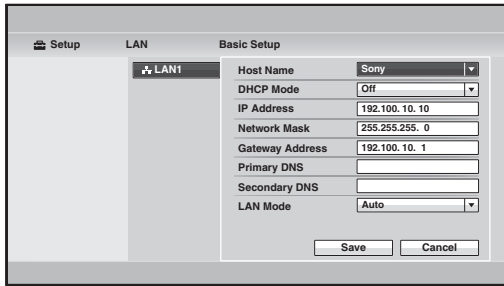

- 2 Set “NAT Mode” to “On” in the NAT Setup page of the LAN setup menu, and enter the appropriate IP address in “WAN IP Address”.

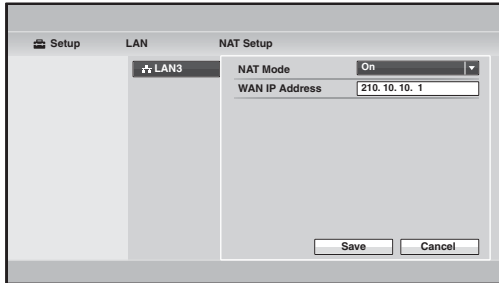

The setting has been configured properly if the correct WAN IP address appears in the Home menu.

To display the NAT address in the Home menu, you must set “Number Display” to “NAT:Address” in the Home Menu 1 page of the Home Menu setup menu (page 76).

- 3 Remote parties must configure the Basic Setup page in the LAN setup menu in the same way.

Note

Remote parties do not need to configure the settings in the NAT Setup page of the LAN setup menu as they are not in a NAT environment.

To connect to a remote party

Select “IP” under “Line I/F”, enter the remote party’s IP address, and dial.

Note

When using the terminal in the NAT environment, you can connect to a remote party (global IP), but for a remote party to connect to you, you must configure your router settings. For details on router settings, consult with the system administrator.

LAN Connection with H.460 Firewall Traversal

You can use H.460 to traverse firewalls and connect with the terminals on other networks.

Configuration example

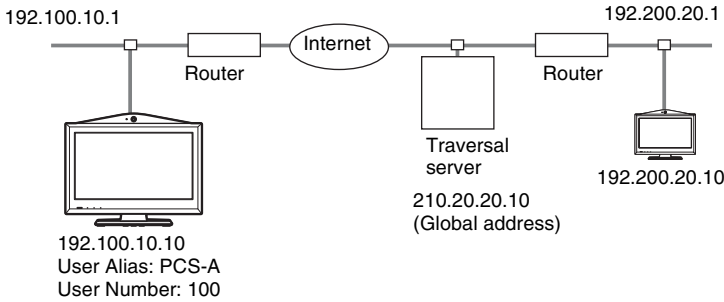

- 1 Enter a name in “Host Name” under the Basic Setup page in the LAN setup menu, and enter the appropriate values for “IP Address”, “Network Mask”, and “Gateway Address”.

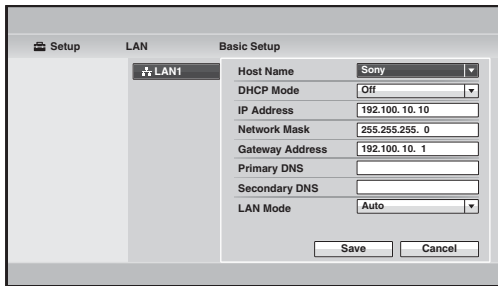

- 2 Set “H.460” to “On” under the Gatekeeper page of the LAN setup menu. Set “Gatekeeper Mode” to “On” and enter the appropriate value for “Gatekeeper Address”.

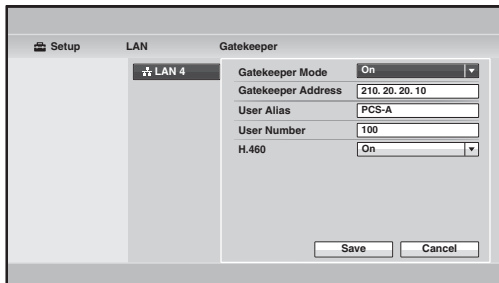

The IP address registered is displayed in the Home menu.

To conduct a video conference

Select “IP” under “Line I/F”, enter the remote party’s IP address, and dial.

LAN Connection Using PPPoE

When using PPPoE, you can connect via LAN without a router. A modem (using bridge mode) is required when using FLET'S ADSL.

Configuration example

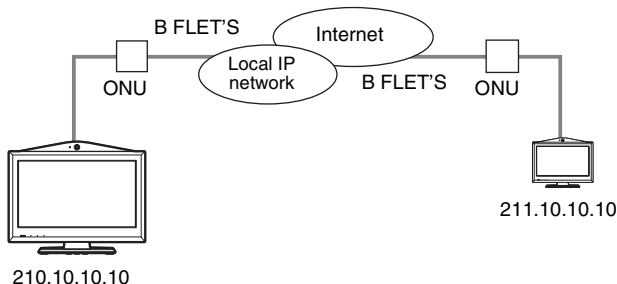

- 1 Set “PPPoE” to “On” under the PPPoE page in the LAN setup menu, and enter the PPPoE user name and PPPoE password given to you by the provider.

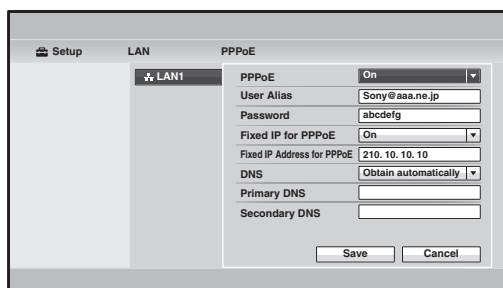

- 2 If you have a fixed IP from the provider, set “Fixed IP for PPPoE” to “On”, and enter your fixed IP address for PPPoE in “Fixed IP Address for PPPoE” under the PPPoE page in the LAN setup menu.

The setting has been configured properly if the correct IP address appears in the Home menu.

Note

If the fixed DNS server address is specified by the provider, set “DNS” to “Specify”, and enter the specific addresses in “Primary DNS” and “Secondary DNS”.

- 3 Remote parties must configure in the same way.

To connect to a remote party

Select “IP” under “Line I/F”, enter the remote party’s IP address, and dial.

ISDN Connections

- 1 Enter the appropriate numbers for “Area Code” and “Local Number” in the Telephone Number page of the ISDN setup menu.

Note

Do not enter the first 0 of the area code.

For details on the ISDN setup menu, see “ISDN Setup Menu” (page 71).

For details on configurations, consult with the system administrator.

The screenshot shows a web-based configuration interface for ISDN. The main menu on the left includes 'Setup', 'ISDN', and 'Number'. The 'ISDN' menu is expanded to show 'ISDN2'. The 'Number' configuration page is active, featuring two columns: 'Area Code' and 'Local Number'. Each column contains input fields for A1, A2, B3, B2, C1, and C2. Below these fields is an 'Auto SPID' checkbox and an 'Execute' button. At the bottom of the page are 'Save' and 'Cancel' buttons.

The setting has been configured properly if the correct line number appears in the Home menu.

- 2 Remote parties must configure in the same way.

Note

When connecting to the ISDN unit, use the ports in ascending order.

Yes: 1, 2, 3...

No: 1, 6, 5...

To connect to a remote party

Select “ISDN” under “Line I/F”, enter the remote party’s line number, and dial.

For details on how to start a visual communication, see “Starting a Connection by Calling a Remote Party” (page 97).

About the Network Routing Check

Before connecting a remote system, you can check the network routing to assure smooth connection with the system.

For the network routing check, knowledge of network is required. Consult your network administrator or Sony dealer.

If you have any questions about the checked result, consult your network administrator or Sony dealer.

To start the network routing check

Open the Network Routing Check menu of the Machine Status menu on the local system that performs the routing check, then set the necessary items on the menu.

Select “Start Measurement” to start the network routing check.

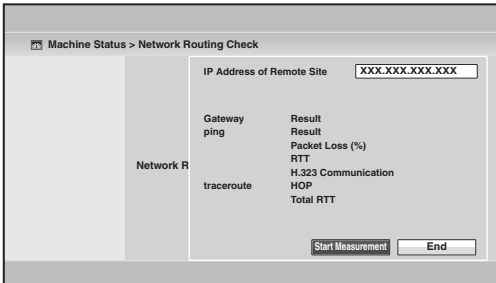

For the procedure how to open the Network Routing Check menu, see “Displaying the Machine Status” on page 83.

Note

While the network routing check is being performed, you cannot use any other functions including communication. When the routing check is complete, the checked results are displayed on the Network Routing Check menu.

Chapter 3: Basic Connection

This chapter describes how to connect to a remote party after the administrator has completed various registrations and settings for the system.

The chapter explains a point-to-point communication via a LAN connection, ISDN connection using the optional PCSA-B384S or PCSA-B768S ISDN Unit or SIP.

For use of optional equipment, see Chapter 4.

To conduct an encrypted communication, see Chapter 5.

To conduct a multipoint communication, see Chapter 6.

Starting a Connection by Calling a Remote Party

You can start a communication with a remote party by dialing. Once you have made a connection to the remote party, you can begin talking just as with a normal phone call and start communication.

You can call a remote party using the various methods described below. Use any one depending on the settings in the Home menu or connecting status.

- To call a remote party by using the Connect menu (page 99)
- To call a remote party by entering their address or number directly (Direct Dial) (page 100)
- To call a remote party by using the one-touch dial buttons (page 101)
- To call a remote party by using the history list (page 102)
- To call a remote party registered in the Phone Book (page 103)
- To call a remote party not registered in the Phone Book by setting the necessary items in the Detailed Dial menu (page 105)

Turning On the Power

- 1** Turn on any external equipment that will be used.
- 2** Press the I/⏻ (power) switch on the Communication System to turn it on.

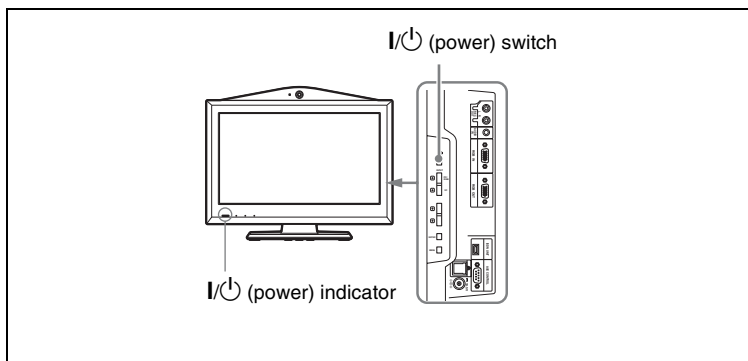

The I (power) indicator on the Communication System flashes. “Starting” appears on the bottom right of the monitor, and then the IPELA logo appears.

When the system has finished starting up, the indicator remains steadily lit in green.

The Home menu appears on the monitor screen and the picture shot by the local camera also appears.

- 3** Check that the lens cover for the camera is open. If it is closed, open it by sliding the lever for the lens cover at the top of the system to the right.

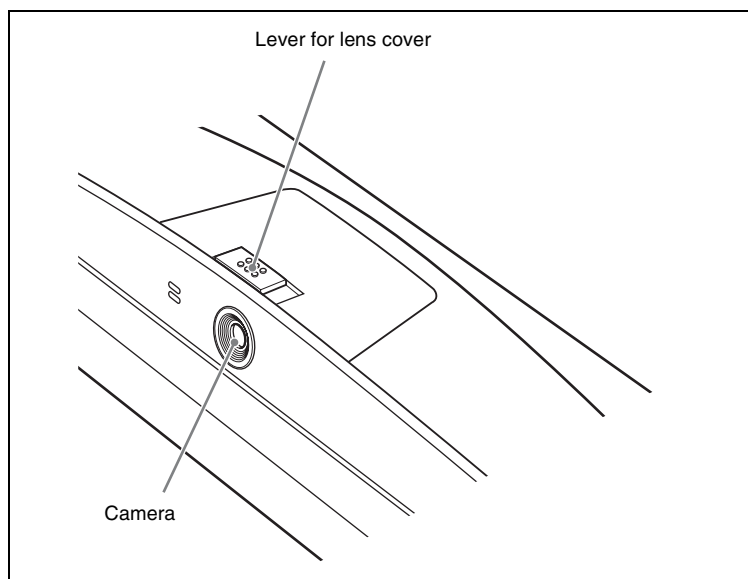

Calling a Remote Party by Using the Connect Menu

This method is available when the Connect button is displayed in the Home menu.

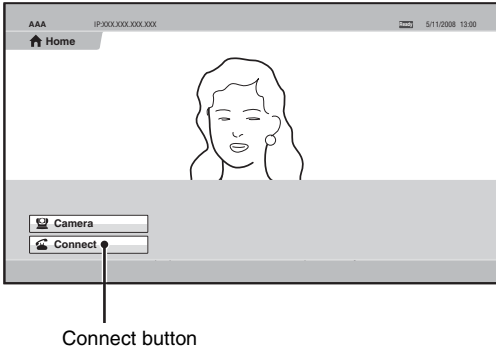

- 1 Use the **↑**, **↓**, **←** or **→** button on the Remote Commander to select “Connect” in the Home menu, then press the ENTER button. The Connect menu appears.

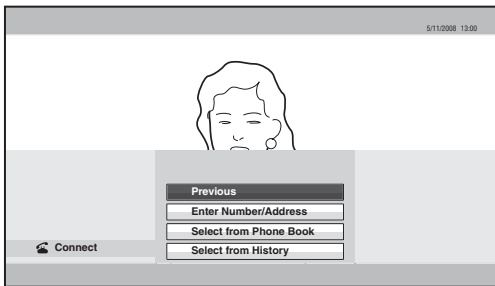

- 2 Use the **↑**, **↓**, **←** or **→** button on the Remote Commander to select how to call a remote party, then press the ENTER button. The menu screen will change according to the item you select.

Enter Number/Address: The Detailed Dial menu appears on the screen.
For the procedure to be followed, see “Calling a Remote Party Not Registered in the Phone Book” on page 105.

Select from Phone Book: The Phone Book appears on the screen.
For the procedure to be followed, see “Calling a Remote Party Registered in the Phone Book” on page 103.

Select from History: The history list appears on the screen.
For the procedure to be followed, see “Calling a Remote Party by Selecting Them in the History List” on page 102.

Calling a Remote Party by Entering Their Address or Number Directly (Direct Dial)

When “Direct Dial” is set to “On” in the Home Menu setup menu, the number input box, Dial button, etc. are displayed in the Home menu, allowing you to use the direct dial function.

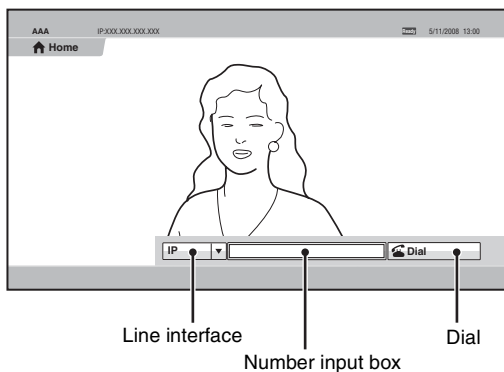

- 1 Use the **↑**, **↓**, **←** or **→** button on the Remote Commander to select “Line I/F” in the Home menu, then press the ENTER button.
- 2 Use the **↑**, **↓**, **←** or **→** button on the Remote Commander to select the line interface to be used, then press the ENTER button.
IP: Connects to the system on the remote site via a LAN connected to the  (LAN) connector.
ISDN: Connects to the system on the remote site via an ISDN line.
TEL: Connects to a phone on the remote site via an ISDN line for a voice meeting.

Note





When a checkmark is put to “SIP” under “Line Interface” of the Line Interface setup menu, you can select “SIP” from the line interface select box.

- 3 Use the **↑**, **↓**, **←** or **→** button on the Remote Commander to select the number input box, then press the ENTER button.
- 4 Enter the remote party’s IP address or line number with the number buttons on the Remote Commander, then press the ENTER button.

Note

The format of the address for a SIP connection is the following:

- 4000 (number assigned by the SIP server)
- 4000@sip.com
- 192.168.1.1 (when the IP address and SIP server are not used)

- 5 Press the CONNECT () button on the Remote Commander. Or use the , ,  or  button on the Remote Commander to select “Dial”, then press the ENTER button.

The system begins dialing the IP address or telephone number entered in step 4. “Dialing” appears on the monitor screen.

When the system connects to the remote system, the message “Session Connected.” appears on the screen and the picture on the remote site is displayed. Now you can start communication with the remote party.

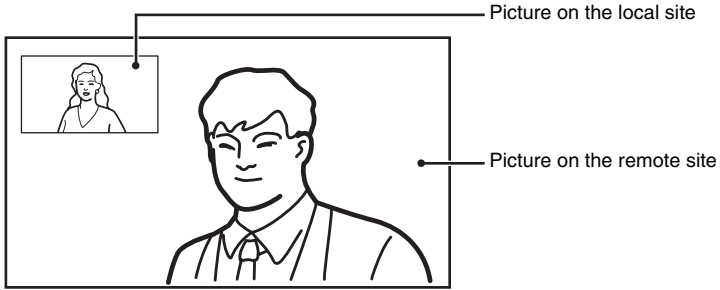









To cancel dialing before connecting with the remote party

While “Dialing” is displayed on the monitor screen, press the DISCONNECT () button or the ENTER button on the Remote Commander.

Calling a Remote Party Using the One-Touch Dial Buttons

When “One-Touch Dial” is set to “On” in the Home Menu setup menu, the one-touch dial buttons are displayed in the Home menu, allowing you to use the one-touch dial function.

For registration of the one-touch dial buttons, see “Registering a Remote Party – Phone Book” on page 112.

- 1 Open the Home menu.
- 2 Select the one-touch dial button for which the remote party you want to call is registered with one of the F1 to F4 buttons on the Remote Commander. Or select the one-touch dial button you want to call in the Home menu by pressing the , ,  or  button on the Remote Commander, then press the ENTER button. Select “Connect” from the displayed submenu with the , ,  or  button, and press the ENTER button.

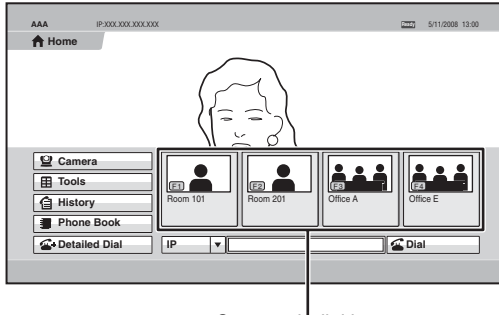

One-touch dial buttons

The system begins dialing the selected remote party. “Dialing” appears on the monitor screen. When the system connects to the remote system, “Session Connected.” appears on the screen and the picture on the remote site is displayed. Now you can start communication with the remote party.

To cancel dialing before connecting with the remote party

While “Dialing” is displayed on the monitor screen, press the DISCONNECT () button or the ENTER button on the Remote Commander.

Calling a Remote Party by Selecting Them in the History List

- 1 Use the **↑**, **↓**, **←** or **→** button on the Remote Commander to select “History” in the Home menu, then press the ENTER button. Or select “Connect” in the Home menu with the **↑**, **↓**, **←** or **→** button and the ENTER button to display the Connect menu, then select “Select from History”. The History menu appears.

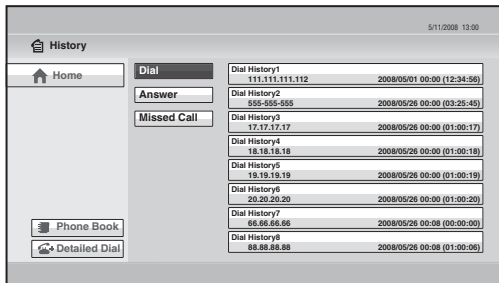

Note

You can display the History menu by selecting “History” from the Phone Book or Detailed Dial menu.

- 2 Use the **↑**, **↓**, **←** or **→** button on the Remote Commander to select “Dial (outgoing call history)”, “Answer (incoming call history)” or “Missed Call (incoming call history in absence)”, then press the ENTER button or **→** button.

The selected history list appears.

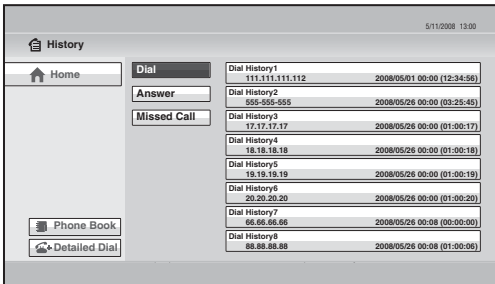

- 3 Use the **↑**, **↓**, **←** or **→** button on the Remote Commander to select the remote party you want to call.

- 4 Press the CONNECT () button on the Remote Commander. Or press the ENTER button to display the submenu, select “Connect” with the **↑**, **↓**, **←** or **→** button, and press the ENTER button.

The system begins dialing the selected party. “Dialing” appears on the monitor screen. When the system connects to the remote system, “Session Connected.” appears on the screen and the picture on the remote site is displayed. Now you can start communication with the remote party.

To cancel dialing before connecting with the remote party

While “Dialing” is displayed on the monitor screen, press the DISCONNECT () button or the ENTER button on the Remote Commander.

Note

You can select the items below from the submenu:

- “**Cancel**”: Cancels selection from the history list.
- “**Edit**”: Displays the List Edit menu for registration in the Phone Book.
- “**Delete**”: Deletes the selected call from the history list.

Calling a Remote Party Registered in the Phone Book

For the registration in the Phone Book, see “Registering a Remote Party – Phone Book” on page 112.

- 1 Use the **↑**, **↓**, **←** or **→** button on the Remote Commander to select “Phone Book” in the Home menu, then press the ENTER button. Or select “Connect” in the Home menu with the **↑**, **↓**, **←** or **→** button and the ENTER button to display the Connect menu, then select “Select from Phone Book”. The Phone Book appears on the monitor screen.

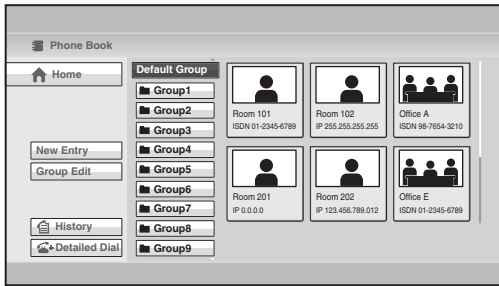

- 2 Use the **↑**, **↓**, **←** or **→** button on the Remote Commander to select the Group in which the remote party you want to call is registered, then press the ENTER button.
- 3 Use the **↑**, **↓**, **←** or **→** button on the Remote Commander to select the remote party you want to call.
- 4 Press the CONNECT () button on the Remote Commander. Or press the ENTER button to display the submenu, select “Connect” with the **↑**, **↓**, **←** or **→** button, and press the ENTER button.

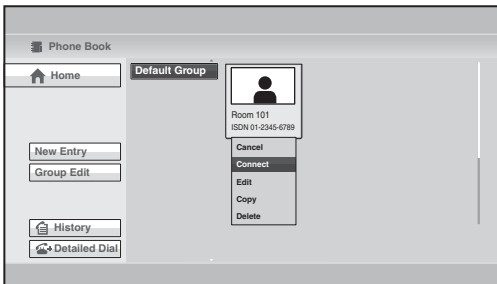

The system begins dialing the selected party. “Dialing” appears on the monitor screen. When the system connects to the system on the remote site, the message “Session Connected.” appears on the screen, and the picture on the remote site is displayed.

Now you can start communication with the remote party.

To cancel dialing before connecting

While “Dialing” is displayed on the monitor screen, press the DISCONNECT () button or the ENTER button on the Remote Commander.

To switch the display in the Phone Book between the list and the thumbnails

Each time the F1 button on the Remote Commander is pressed, the display changes between the list and the thumbnails.

To change the order of display

Each time the F2 button on the Remote Commander is pressed, the display changes between the list of remote parties' names in ascending alphabetical order and that list in descending alphabetical order.

To display the Phone Book during communication

Press the # button on the Remote Commander during communication.

To call a remote party registered in the Private Phone Book

- 1 Insert the “Memory Stick” that contains the Private Phone Book into the Memory Stick slot on the Communication System.
The Phone Book changes to the Private Phone Book.
- 2 Select “Private Phone Book” in the Home menu, and press the ENTER button.
- 3 Use the **↑**, **↓**, **←** or **→** button on the Remote Commander to select a remote party you want to call from the Private Phone Book.
- 4 Press the CONNECT () button on the Remote Commander. Or press the ENTER button to display the submenu, select “Connect” with the **↑**, **↓**, **←** or **→** button, and press the ENTER button.

Note

If the auto dialing feature of the Private Phone Book is activated, the system begins dialing when the “Memory Stick” is inserted.

Calling a Remote Party Not Registered in the Phone Book

- 1 Use the **↑**, **↓**, **←** or **→** button on the Remote Commander to select “Detailed Dial” in the Home menu, then press the ENTER button. Or select “Connect” in the Home menu with the **↑**, **↓**, **←** or **→** button and the ENTER button to display the Connect menu, then select “Enter Number/Address”. The Detailed Dial menu appears on the screen.

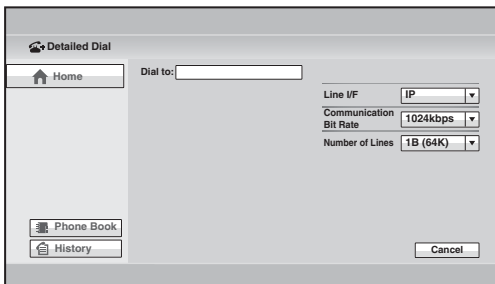

2 Select the line interface to be used for connection.

Use the **▲**, **▼**, **◀** or **▶** button to select “Line I/F”, then press the ENTER button. The setting items appear. Press the **▲**, **▼**, **◀** or **▶** button to select the line interface to be used to connect to the remote party, then press the ENTER button.

IP: Connects to a remote party via a LAN connected to the **LAN** (LAN) connector.

ISDN: Connects to a remote party via an ISDN.

ISDN (2B): Connects to the H.221-format system via 2B channels of the ISDN connection.

TEL: Connects to the phone of a remote party to conduct a voice meeting via the ISDN connection.

Note

When a checkmark is put to “SIP” under “Line Interface” of the Line Interface setup menu, you can select “SIP” from “Line I/F”.

3 Configure the LAN or ISDN line to be used for connection.

When using the LAN

① Enter the IP address of a remote party to connect in the IP text box.

Use the **▲**, **▼**, **◀** or **▶** button on the Remote Commander to select the IP text box, then press the ENTER button. Next, enter the IP address with the number buttons on the Remote Commander or the on-screen keyboard, and press the ENTER button.

Enter the host name and domain name (ex. host.domain) when using the DNS server, or enter the party’s user name and user number registered in the LAN setup menu on the remote party’s system when using the gatekeeper, then press the ENTER button.

Notes

- When “Internet Protocol” is set to “IPv4” in the Administrator setup menu, you can enter a dot (.) with the **▶** or DOT button.
- When “Internet Protocol” is set to “IPv6” or “IPv4/IPv6” in the Administrator setup menu, you can enter a colon (:) with the **▶** or DOT button.
When “IPv4/IPv6” is specified, only colons can be entered with the **▶** button. When “IPv4/IPv6” is specified and you are calling using IPv4, press the DOT button twice to enter a dot.
- To delete the last entered character, use the BACK SPACE button on the Remote Commander or “Back Space” on the on-screen keyboard.
- To delete the entered IP address, use the RETURN button on the Remote Commander or “Cancel” on the on-screen keyboard.

② Select the communication bit rate.

Use the **▲**, **▼**, **◀** or **▶** button to select “Communication Bit Rate”, then press the ENTER button. Press the **▲**, **▼**, **◀** or **▶** button to select the communication bit rate from the displayed submenu, then press the ENTER button.

When using the ISDN

- ① Enter the telephone number of a remote party to connect in the A text box.

Use the **▲**, **▼**, **◀** or **▶** button on the Remote Commander to select the A text box, then press the ENTER button. Next, enter the telephone number with the number buttons on the Remote Commander or on-screen keyboard, and press the ENTER button.

Notes

- Do not enter the prefix number in the telephone number text box, when the prefix setting is on. For details on prefix settings, see “Dial Setup Menu” on page 57.
- Even when you connect multiple ISDN lines (2B (128K) or more number of lines), entering one telephone number of the remote party enables you to connect all the lines used automatically.
- When you select ISDN (2B (128K)), the A1 and A2 text boxes appear. You can enter a separate ISDN line number in each text box. Pressing the ENTER button on the Remote Commander while the A2 text box is selected copies the number entered in the A1 text box to the A2 text box.
- To delete the last entered character, use the BACK SPACE button on the Remote Commander or “Back Space” on the on-screen keyboard.
- To delete the entered ISDN telephone number, use the RETURN button on the Remote Commander or “Cancel” on the on-screen keyboard.

- ② Select the number of ISDN lines to use during the call.

Use the **▲**, **▼**, **◀** or **▶** button on the Remote Commander to select “Number of Lines”, then press the ENTER button. Press the **▲**, **▼**, **◀** or **▶** button to select the number of channels to be used when calling a remote party from the displayed items, then press the ENTER button.

Note

To connect to the remote party by entering all the telephone numbers for the ISDN lines used

If the system of the remote party is not equipped with the bonding function, entering one remote party’s telephone number does not allow automatic connection of multiple ISDN lines used to connect to the remote party. To connect to the remote party by entering all the telephone numbers, register the remote party’s telephone numbers for the ISDN lines to be used referring to “Registering a Remote Party – Phone Book”(page 112), then connect to the remote party according to the procedure described in “Calling a Remote Party Registered in the Phone Book” (page 103).

- 4 Press the CONNECT () button on the Remote Commander, or use the **▲**, **▼**, **◀** or **▶** button to select “Connect” in the lower part of the menu, then press the ENTER button on the Remote Commander.

The system begins dialing the IP address or ISDN telephone number entered in step 3. “Dialing” appears on the monitor screen.





When the system connects to the remote system, the message “Session Connected.” appears on the screen, and the picture on the remote site is displayed. Now you can start communication with the remote party.

To cancel dialing before connecting

While “Dialing” is displayed on the monitor screen, press the DISCONNECT () button or the ENTER button on the Remote Commander.

To save the entered IP address or ISDN telephone number in the Phone Book

When you enter the IP address or ISDN telephone number, the Save button appears at the lower part of the menu.

Select “Save” with the , ,  or  button, then press the ENTER button on the Remote Commander. The List Edit menu is displayed. Save the address or number you entered into the Phone Book.

For details on the List Edit menu, see “Registering a Remote Party – Phone Book” on page 112.

Redial function

Once you have input the IP address or ISDN telephone number using the Detailed Dial menu, it will be entered in the text box of the Detailed Dial menu the next time you open the menu.

Note

The redial function is not available:

- Once you have turned off the power of the system or set it to standby mode.
- When you cancel dialing the entered IP address or ISDN telephone number.

Receiving a Call from a Remote Party

Operations for answering a call differ depending on the setting of the answer mode.

Note

The unit is set to manual answer mode under factory default settings.

Answering Calls (Manual/Auto Answer Mode)

Manual answer mode

When there is an incoming call, the Communication System rings. You need to connect the call manually.

You can start connecting when you are ready.

Auto answer mode

The system automatically receives a call from a remote party and you can start connecting. Although no operation is necessary to start, the picture on the local site will be displayed on the remote site screen even if you are not ready to begin.

Note

You cannot answer the call unless the power switch on the Communication System is on.

For setting of the answer mode, see “Auto Answer” in the Answer setup menu on page 58.

Answering a Call from a Remote Party

To receive a call in manual answer mode

When you receive a call, the Communication System rings and the message “Incoming call. Answer?” appears on the monitor screen.

Press **▲**, **▼**, **◀** or **▶** to select “OK”, then press the ENTER button. The system is then connected. Once the connection is made, the picture of the remote party is displayed on the local monitor screen and the sound is heard. The picture and sound on the local site will be enabled on the remote site at the same time. The message “Session Connected.” appears on the monitor screen. You are now ready to start a communication.

Note

See pages 123 to 131 to adjust the sound and picture during communication.

When you do not want to answer the call

Press **↑**, **↓**, **←** or **→** to select “Cancel”, then press the ENTER button. Ringing stops, and the connection is canceled.

To answer a call in auto answer mode

When you receive a call, the Communication System rings and the message “Answering...” appears on the monitor screen. The system is automatically connected and the picture of the remote party is displayed on the local monitor screen and the sound is heard. The picture and sound on the local site will be enabled on the remote site at the same time.

The message “Session Connected.” appears on the monitor screen.

You are now ready to start communication.

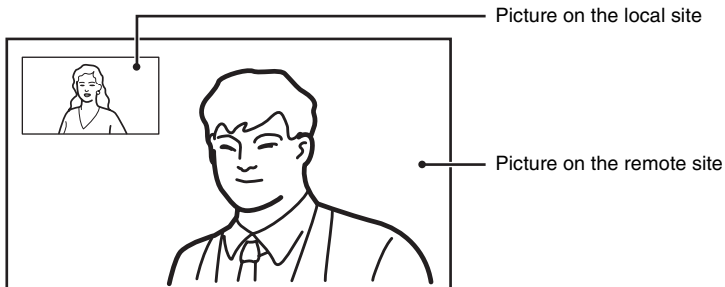

Note







See pages 123 to 131 to adjust the sound and picture during communication.

When the system fails to make an ISDN connection

If the system fails to connect to the remote party, the message “Cannot complete connection. (an ISDN cause code and a message are displayed here)” appears on the monitor screen.

For details on ISDN cause codes and messages, see “On-Screen Messages” on page 222.





Ending the Connection

- 1 Press the DISCONNECT () button on the Remote Commander.
The message “Disconnect?” appears on the monitor screen.
- 2 Press the DISCONNECT () button on the Remote Commander again, or press the , ,  or  button on the Remote Commander to select “OK”, then press the ENTER button.
The system is disconnected.

Note

The power of the Communication System remains on even if the system is disconnected.

To cancel disconnection of the system

Select “Cancel” with the , ,  or  button on the Remote Commander, then press the ENTER button.

To register the connected remote party in the Phone Book

You can easily register the remote party who has just disconnected. If you set “Last Number Registration” to “On” on the Device Setup page of the General setup menu, the message “Register this participant in the list?” appears after a communication with an unregistered remote party is finished. When you select “OK”, the List Edit menu appears.

Note

If the “Last Number Registration” is set to “Off”, the message does not appear.

For “Last Number Registration” setting, see “General Setup Menu” on page 74.

Registering a Remote Party – Phone Book

You can register the telephone number or IP address of a remote party in the Phone Book, allowing you to dial the party very easily.

Up to 1000 remote parties can be registered in the Phone Book. You can also store a still image such as a participant’s portrait in the index list.

You can also create a Private Phone Book on a “Memory Stick” separately from the Phone Book in the Communication System.

Registering a New Remote Party

- 1 Use the **↑**, **↓**, **←** or **→** button on the Remote Commander to select “Phone Book” in the Home menu, then press the ENTER button. Or select “Connect” in the Home menu with the **↑**, **↓**, **←** or **→** button and the ENTER button to display the Connect menu, then select “Select from Phone Book”. The Phone Book opens.

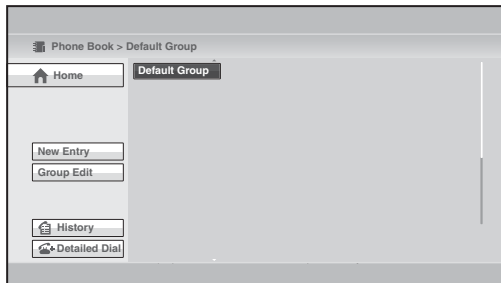

Note

The Phone Book can be displayed by selecting “Phone Book” in the History or Detailed Dial menu.

- 2 Use the **↑**, **↓**, **←** or **→** button on the Remote Commander to select “New Entry”, then press the ENTER button. The List Edit menu appears.

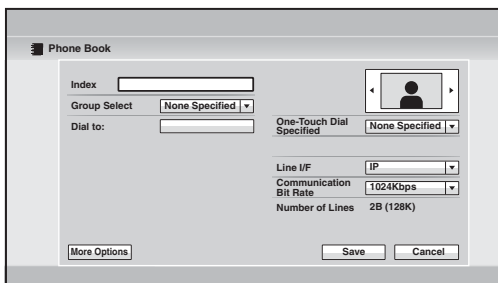

3 Set the items in the List Edit menu.

Use the **↑**, **↓**, **←** or **→** button and the ENTER button on the Remote Commander to select the setup item.

To enter the characters, use the number buttons on the Remote Commander or the displayed on-screen keyboard, and press the ENTER button. To select the item, use the **↑**, **↓**, **←** or **→** button and press the ENTER button.

Index

Enter the name of a remote party in the Index text box. You can use up to 39 letter and number characters.

Group Select

Select the group set in the Phone Book.

Dial to:

Enter the IP address or line number of a remote party depending on the line interface you select.

When you select “IP” from “Line I/F”: Enter the remote party’s IP address. Enter the host name and domain name (ex. host.domain) when using the DNS server, or enter the party’s user name and user number when using the gatekeeper (page 68).

When you select “ISDN” from “Line I/F”: Enter the remote party’s line number. If you register the sub-address in the Phone Book, enter an asterisk between the line number and sub-address. The sub-address can only be composed of numbers.

When “More Options Enable” is set to “On” in the Dial setup menu (page 57), six line input text boxes, A1, A2, B1, B2, C1 and C2, are displayed. Be sure to enter the remote party’s number to the A1 text box.

When you select “TEL” from “Line I/F”: Enter the telephone number of a remote party. (ex. 0390123456)

When you select “SIP” from “Line I/F”: Enter the address of a remote party or the number assigned by the SIP server.

The format of the address is the following:

- 4000 (number assigned by the SIP server)
- 4000@sip.com
- 192.168.1.1 (when the IP address and SIP server are not used)

Icon/Image

Select the icon or a still image stored on a “Memory Stick” to be displayed on the Phone Book.

Note

You cannot select a still image unless a “Memory Stick” in which still images are stored is inserted.

One-Touch Dial Specified

Select whether to display the one-touch dial buttons in the Home menu. Assign the F1, F2, F3 or F4 function button on the Remote Commander to each one-touch dial button.

Line I/F

Select the line interface you are using to connect to a remote party. Select from among IP, ISDN, TEL and SIP. Selecting any interface switches the setting items in the List Edit menu.

Note

When a checkmark is put to “SIP” under “Line Interface” of the Line Interface setup menu, you can select “SIP” from “Line I/F”.

Communication Bit Rate

Select the communication bit rate when you select “IP” or “SIP” with “Line I/F”.

Number of Lines

Select the number of ISDN channels to be used when you select “ISDN” with “Line I/F”.

Auto Dial

Set this item only for the Private Phone Book (page 119). Setting “Auto Dial” to “On” allows you to automatically dial one of the lists in the Private Phone Book simply by inserting the “Memory Stick” in which the Private Phone Book is registered.

- 4 Use the **↑**, **↓**, **←** or **→** on the Remote Commander to select “Save”, then press the ENTER button.
The settings are registered in the Phone Book.

Note

When a connection with a remote party not registered in the Phone Book is terminated, you can register this remote party to the Phone Book. In this case, the IP address or line number is shown in “Index” as the name of the remote party. Modify it if necessary.

To connect to the remote party without using bonding

If the system of the remote party is not equipped with the bonding function, entering one telephone number does not allow you to connect all the line numbers used to connect to the remote party. To connect to the remote party by entering all the ISDN line numbers used, you can set the connection without using the bonding function of this system.

When you set “More Options Enable” to “On” in the Dial setup menu (page 57), the A1, A2, B1, B2, C1 and C2 text boxes appear in the List Edit menu. Enter all the telephone numbers for the ISDN lines selected by “Number of Lines”.

Note

When you set “Number of Lines” to “2B”, you can connect to the remote party by selecting “ISDN (2B)” from “Line I/F” in the Detailed Dial menu.

To set up more detailed options

When “More Options Enable” is set to “On” in the Dial setup menu, the More Options button is shown at the lower part of the List Edit menu. Select the More Options button with the **▲**, **▼**, **◀** or **▶** button on the Remote Commander and press the ENTER button to open a menu for more detailed dial settings. You can change the settings of the desired items.

Note

The contents set with the More Options button have priority over those set in the Dial setup menu.

Editing the Contents of the Phone Book

You can edit the telephone number, IP address, name or setting registered in the Phone Book.

- 1 Open the Phone Book.
- 2 Use the **▲**, **▼**, **◀** or **▶** button on the Remote Commander to select the remote party to be modified, then press the ENTER button.
The submenu appears.

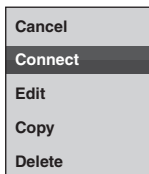

- 3 Press the **▲**, **▼**, **◀** or **▶** button on the Remote Commander to select “Edit”, then press the ENTER button.
The List Edit menu appears.

- 4 Modify the telephone number, IP address, name or setting.
- 5 Use the **▲**, **▼**, **◀** or **▶** button on the Remote Commander to select “Save”, then press the ENTER button.
The modification is completed.

Copying a Registered Party in the Phone Book

- 1 Open the Phone Book.
- 2 Use the **▲**, **▼**, **◀** or **▶** button on the Remote Commander to select the remote party to be copied, then press the ENTER button.
The submenu appears.
- 3 Press the **▲**, **▼**, **◀** or **▶** button on the Remote Commander to select “Copy”, then press the ENTER button.
The items for the selected party are copied, and the name is followed by “-2”. You can use the setting after modifying the necessary items.

Deleting the Registered Remote Party

- 1 Open the Phone Book.
- 2 Use the **▲**, **▼**, **◀** or **▶** button on the Remote Commander to select the remote party to be deleted from the Phone Book, then press the ENTER button.
The submenu appears.
- 3 Press the **▲**, **▼**, **◀** or **▶** button on the Remote Commander to select “Delete”, then press the ENTER button.
The message “Delete Entry?” appears.
- 4 Use the **▲**, **▼**, **◀** or **▶** button on the Remote Commander to select “OK”, then press the ENTER button.
The selected party is deleted.

To cancel deleting

Select “Cancel” in step 4, then press the ENTER button.

Creating a Group in the Phone Book (Group Edit)

You can create groups into which the registered remote parties are grouped.

To register a new group

- 1 Open the Phone Book.

- 2 Use the **↑**, **↓**, **←** or **→** button on the Remote Commander to select “Group Edit”, then press the ENTER button.

The Phone Book > Group Edit menu appears.

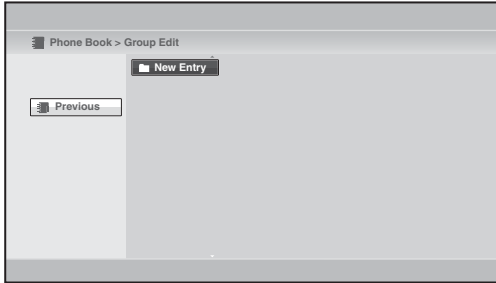

- 3 Use the **↑**, **↓**, **←** or **→** button on the Remote Commander to select “New Entry”, then press the ENTER button.

The group name input menu appears.

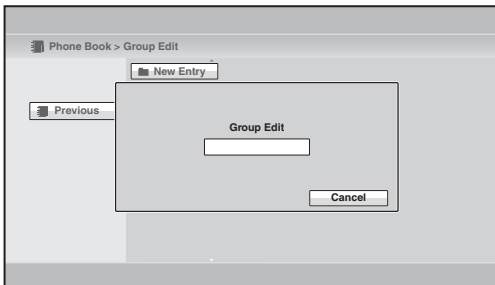

- 4 Enter the group name using the number buttons on the Remote Commander and the on-screen keyboard, then press the ENTER buttons. You can use the alphabetical letters, numbers and symbols.

- 5 Use the **↑**, **↓**, **←** or **→** button on the Remote Commander to select “Save”, then press the ENTER button.

The registered group button is displayed.



- 6 Use the **↑**, **↓**, **←** or **→** button on the Remote Commander to select “Previous”, then press the ENTER button.
The Phone Book is restored.

To modify the group name

- 1 Open the Phone Book > Group Edit menu, select the group button you want to modify using the **↑**, **↓**, **←** or **→** button on the Remote Commander, and press the ENTER button.
The submenu appears.

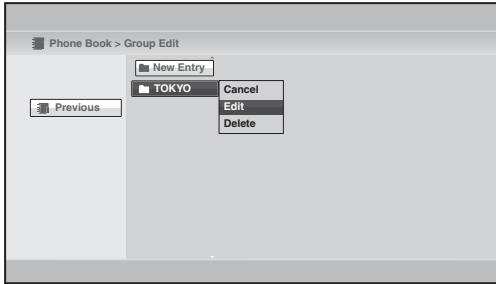

- 2 Use the **↑**, **↓**, **←** or **→** button on the Remote Commander to select “Edit”, then press the ENTER button.
The group name input menu appears.
- 3 Modify the group name using the number buttons on the Remote Commander and the on-screen keyboard, then press the ENTER buttons.
- 4 Use the **↑**, **↓**, **←** or **→** button on the Remote Commander to select “Save”, then press the ENTER button.
The modified group button is displayed in the Phone Book > Group Edit menu.

Notes

- You can operate the following with a submenu in the Group Edit menu.
 - “**Cancel**”: Cancels selection of the group button.
 - “**Delete**”: Deletes a group in which no party is registered.
- You cannot delete a group button for which any remote parties are registered.

Creating a Private Phone Book

You can create your own Phone Book (Private Phone Book) on a “Memory Stick”. Once the Private Phone Book is registered, inserting the “Memory Stick” into the Communication System changes the Phone Book to the Private Phone Book. You can also activate the Auto Dial feature, allowing you to automatically start dialing one of the remote parties registered in the Private Phone Book simply by inserting the “Memory Stick”.

To register a new remote party in a Private Phone Book

- 1 Insert a “Memory Stick” in which you want to register a remote party into the Memory Stick slot on the Communication System.
Insert the “Memory Stick” in the direction of the arrow with the mark facing upward.

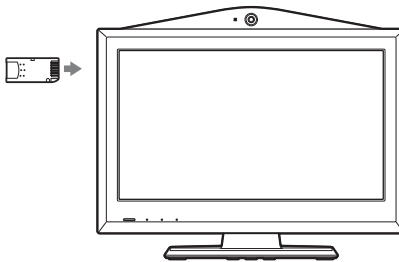

- 2 Open the Phone Book page in the Administrator setup menu.

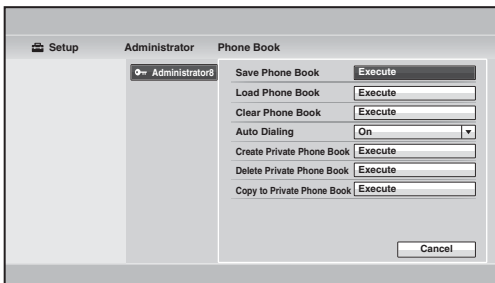

For how to open the menu, see “Registering Local Information” on page 54.

- 3 Select “Create Private Phone Book”.
An empty folder and file for a Private Phone Book are created in the “Memory Stick”.

- 4 Register a new remote party.
The procedure is the same as that for registering in the Phone Book. Proceed with steps 2 to 4 in “Registering a New Remote Party” on page 112.

The procedures for how to edit the contents of the Private Phone Book, how to delete the registered remote party, or how to copy one of the registered parties in the Private Phone Book are the same as those for the Phone Book. Open the Private Phone Book and proceed with the steps described on pages 115 to 116.

To copy all the contents of the Phone Book to the Private Phone Book

Insert the “Memory Stick” in which you want to store the Private Phone Book into the Memory Stick slot on the Communication System, then select “Copy to Private Phone Book” in the Administrator setup menu. All the data registered in the Phone Book are copied to the inserted “Memory Stick”.

To delete the Private Phone Book from the “Memory Stick”

Insert the “Memory Stick” from which you want to delete the registered Private Phone Book into the Memory Stick slot on the Communication System, then select “Delete Private Phone Book” on the Phone Book page in the Administrator setup menu. All the data are deleted from the inserted “Memory Stick”.

To dial a specified remote party in a Private Phone Book automatically

If you set “Auto Dialing” in the Administrator setup menu to “On”, you can automatically dial one of the registered remote parties in the Private Phone Book simply by inserting the “Memory Stick” in which the Private Phone Book is registered.

- 1 Open the Private Phone Book.
- 2 Use the **▲**, **▼**, **◀** or **▶** button on the Remote Commander to select the remote party to dial automatically, then press the ENTER button.
- 3 Press the **▲**, **▼**, **◀** or **▶** button on the Remote Commander to select “Edit”, then press the ENTER button.
The List Edit menu appears.
- 4 Use the **▲**, **▼**, **◀** or **▶** button on the Remote Commander to select “Auto Dialing”, then press the ENTER button.
The setting is registered and “AUTO” appears in the Private Phone Book.

Using the Shared Phone Book

Using the Shared Phone Book function enables multiple Sony Visual Communication Systems to access a Phone Book located on a server.

For detailed configuration, consult your network administrator.

Notes

- You can dial a remote party registered in the Shared Phone Book in the same manner as with the Phone Book. However, you cannot dial a remote party registered in a multipoint connection list.
- You cannot register a new party, delete a registered party, attach an image, or edit the Shared Phone Book. In addition, you cannot copy the remote parties registered in the Shared Phone Book to the Private Phone Book.

System configuration example

In this system configuration, sharing of a Phone Book using H.350 is enabled.

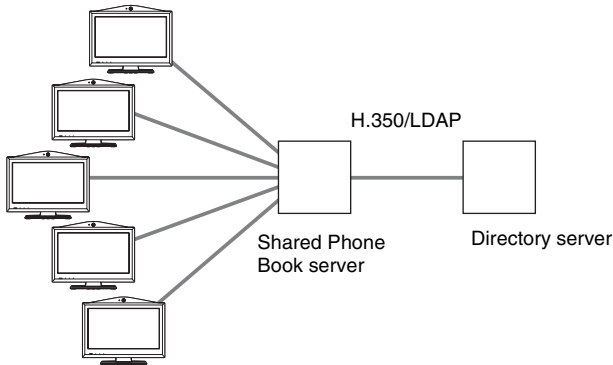

Using the Shared Phone Book

Check that “SPB Mode” is set to “On” in the Shared Phone Book setup menu, and enter appropriate values for “SPB Server Address” and “SPB Server Password”.

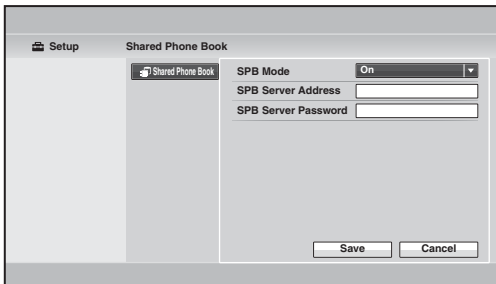

When “SPB Mode” is set to “On”, the Shared Phone Book menu button appears on the screen.

To display the Shared Phone Book

Select “Shared Phone Book” in the Phone Book, and press the ENTER button. The display switches to the Shared Phone Book.

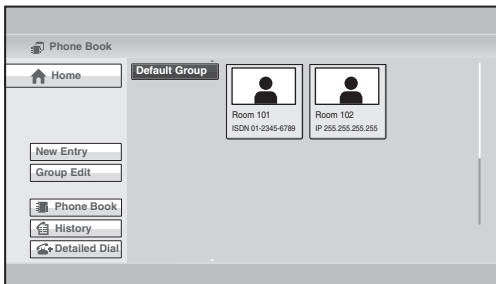

To restore the Phone Book, select “Phone Book” in the menu, and press the ENTER button.

The procedure for dialing the registered remote party in the Shared Phone Book is the same as that for the Phone Book.

For details on dialing, see “Calling a Remote Party Registered in the Phone Book” on page 103.

Adjusting the Sound

Adjusting the Volume of the Received Sound

You can adjust the volume of the sound to be received from a remote party. Press the VOLUME + button on the Remote Commander to increase the volume, VOLUME – button to decrease it. The volume level indicator appears on the monitor screen. The indicator will automatically disappear if you do not operate the buttons for a certain time.



Note

If feedback or distortion caused by increasing the volume occurs, decrease the volume.

Turning Off the Sound Momentarily – Muting Function

You can momentarily turn off the sound to be sent to the remote party during communication.



Press the MIC ON/OFF button on the Remote Commander.

The sound of the local party is not heard by the remote party. The  NEAR indicator appears on the monitor screen of the local site.

The  FAR indicator appears on the monitor screen of the remote site, indicating that the sound of the local party is not transmitted.

To restore the sound

Press the MIC ON/OFF button again.

The  NEAR indicator on the local site and the  FAR indicator on the remote site disappear and the sound is heard by the remote party.

Turning Off the Sound on Answering – Mic on Answer Function

You can turn off the sound to be sent to a remote party when you have answered a call from the remote party.

If you set “Mic on Answer” to “Off” in the Answer setup menu, only the picture on the local party will be sent to the remote party when answering a call. The  NEAR indicator appears on the monitor screen.

For the setting, see “Mic on Answer” in the Answer setup menu on page 58.

To send the sound to the remote party

Press the MIC ON/OFF button on the Remote Commander.

The  NEAR indicator disappears and the sound is heard by the remote party.

Synchronizing Audio and Video – Lip Sync Function

During the communication a time lag may occur between the sound and picture to be sent to the remote party, which prevents smooth communication. Using the Lip Sync function adjusts to synchronize audio and video. However, this may delay transmission of audio synchronized with video.

The Lip Sync function is enabled if you set “Lip Sync” to “Auto” on the Basic Setup1 page in the Audio setup menu.

For the setting, see “Lip Sync” in the Audio setup menu on page 63.

Note

To enable the Lip Sync function of the remote party, you have to ask them to do so.

Reducing Echo – Echo Canceller

The Communication System is equipped with the echo canceller function, allowing the echo that occurs during audio transmission to be reduced. Setting “Echo Canceller” to “On” on the Basic Setup1 page in the Audio setup menu activates the built-in echo canceller.

Adjusting the Camera

You can adjust the image shot by the local camera that is sent to the remote party to obtain the desired angle and size.

During communication you can also control the camera on the remote site to adjust the image shot by the remote camera.

Adjusting the Camera Zoom

Determine the size of the picture to be displayed on the monitor screen by adjusting the zoom.

- 1 Press the CAMERA button on the Remote Commander, or press the **▲**, **▼**, **◀** or **▶** button to select “Camera” in the Home menu and press the ENTER button.

The Camera menu appears.

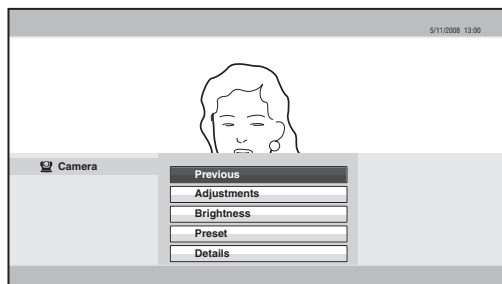

- 2 Select the camera to be adjusted.
During communication pressing the F1 button on the Remote Commander switches between the camera on the local site and that on the remote site.
- 3 Use the **▲**, **▼**, **◀** or **▶** button on the Remote Commander to select “Adjustments”, then press the ENTER button.
The Adjustments menu appears.

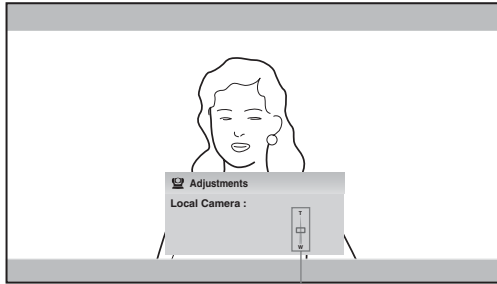

Zoom indicator

- Use the ZOOM button on the Remote Commander to zoom in or out. Press the T (Telephoto) button to zoom in and the W (Wide angle) button to zoom out.

To control the remote camera

- To control the remote camera, set “Far End Camera Control” (page 61) to “On” in the Communication setup menu for both the local and remote sites. If this setting is not configured properly, you will not be able to control the remote camera.
- You cannot control the remote camera during a session if the remote control format of the remote camera is not H.281. If you cannot control the remote camera, ask the remote party about the remote control format of his camera.
- If the local and remote parties try to control the same camera at the same time, the camera may not operate correctly.

Adjusting the Brightness

To adjust the brightness manually

- Press the CAMERA button on the Remote Commander, or press the **▲**, **▼**, **◀** or **▶** button to select “Camera” in the Home menu and press the ENTER button.
The Camera menu appears.

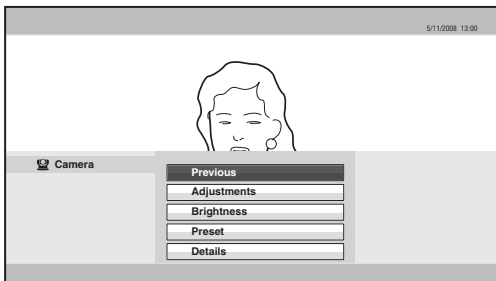

- 2 Select the camera to be adjusted.
During communication pressing the F1 button on the Remote Commander switches between the camera on the local site and that on the remote site.
- 3 Use the **↑**, **↓**, **←** or **→** button on the Remote Commander to select “Brightness”, then press the ENTER button.
The Brightness adjustment menu appears.
- 4 Use the **↑**, **↓**, **←** or **→** button on the Remote Commander to select the brightness adjustment bar, then press the ENTER button.

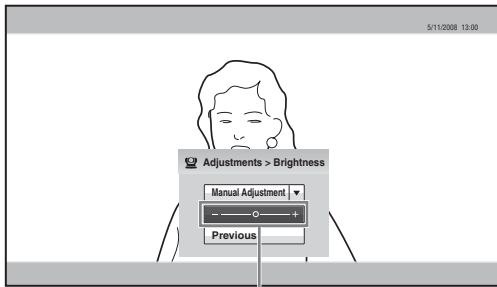

Brightness adjustment bar

- 5 Use the **↑**, **↓**, **←** or **→** button on the Remote Commander to adjust the brightness of the screen.
Pressing the **→** button increases the brightness, and pressing the **←** button decreases it.

Using the Preset Function

The settings for local or remote camera zoom can be registered in the preset memory. Once you have stored the settings, you can easily recall them to move the camera.

Up to 100 settings can be registered for the local camera and up to 6 settings for the remote camera.

To register the preset setting

- 1 Press the CAMERA button on the Remote Commander, or press the **↑**, **↓**, **←** or **→** button to select “Camera” in the Home menu and press the ENTER button.
The Camera menu appears.

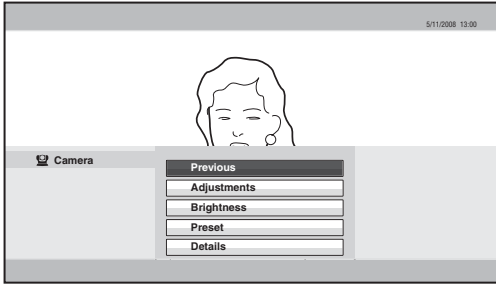

- 2** Select the camera whose zoom setting you want to preset.
During communication pressing the F1 button on the Remote Commander switches between the camera on the local site and that on the remote site.
- 3** Use the **↑**, **↓**, **←** or **→** button on the Remote Commander to select “Preset”, then press the ENTER button.
The Preset Setting List appears.

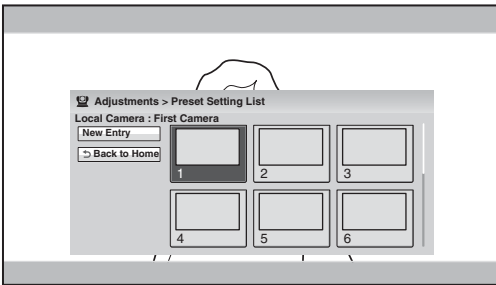

- 4** Use the **↑**, **↓**, **←** or **→** on the Remote Commander to select “New Entry”, then press the ENTER button.
The Preset Save menu appears.

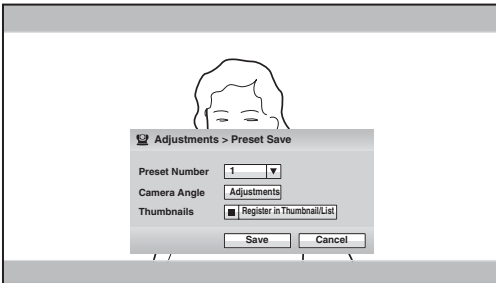

- 5** Use the **↑**, **↓**, **←** or **→** button on the Remote Commander to select “Preset Number”, then select the number to which the setting is stored.
Only the numbers that have not been used for presetting are selectable.

- 6 Use the **↑**, **↓**, **←** or **→** button on the Remote Commander to select “Adjustments” under “Camera Angle”, then press the ENTER button, if you want to adjust the camera zoom.
The Adjustments menu is displayed and you can adjust the zoom.
For the adjustment procedures, see “Adjusting the Camera Zoom” on page 125.
- 7 After the adjustment is finished, press the RETURN button or the ENTER button on the Remote Commander.
The Preset Save menu is restored.
- 8 When you want to register a thumbnail, use the **↑**, **↓**, **←** or **→** button on the Remote Commander to select “Thumbnails” and press the ENTER button to check the checkmark for “Register in Thumbnail/List”.
- 9 Use the **↑**, **↓**, **←** or **→** button on the Remote Commander to select “Save”, then press the ENTER button.
The angle and zoom settings are stored in the selected number, and the preset number is listed in the Preset Setting List.

To move the camera to the preset position

- 1 Press the CAMERA button on the Remote Commander, or press the **↑**, **↓**, **←** or **→** button to select “Camera” in the Home menu and press the ENTER button.
The Camera menu appears.
- 2 Use the **↑**, **↓**, **←** or **→** button on the Remote Commander to select “Preset” in the Camera menu, then press the ENTER button.
The Preset Setting List appears.

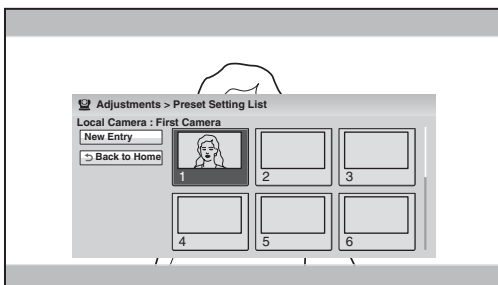

- 3 Use the **↑**, **↓**, **←** or **→** button on the Remote Commander to select the preset number you want to recall, then press the ENTER button.
You can also recall the preset numbers 1 to 6 by pressing the number buttons 1 to 6 on the Remote Commander.
The submenu appears.

- 4 Press the **↑**, **↓**, **←** or **→** button on the Remote Commander to select “Load”, then press the ENTER button.

The camera moves to the selected preset position.

Note

You can select the items below from the submenu:

“**Cancel**”:
Cancels selection of the preset position.

“**Edit**”:
Changes the selected preset position.

“**Delete**”:
Deletes the selected preset position.

Adjusting the Camera in the Detailed Setup Menu

When you select “Details” in the Camera menu, the more detailed setup menu opens. You can adjust various items for camera adjustment.

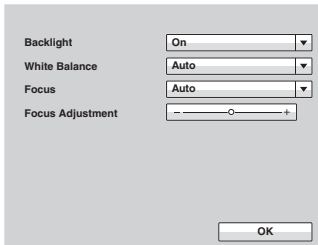

To use backlight compensation function

When the subject is shot with a bright background, set “Backlight” to “On”. The backlight compensation is activated and you can obtain a bright picture.

To adjust the white balance

Set the white balance depending on the shooting location.

Auto: Adjusts the white balance automatically.

Indoor: Select when shooting the subject indoors.

Outdoor: Select when shooting the subject outdoors.

ONE PUSH: Select when adjusting the white balance by shooting a white object in the center of the screen.

To adjust the focus automatically

Select “Auto” in the Focus drop-down list and press the ENTER button. The focus is automatically adjusted.

Note

Depending on your operating environment, the focus may not be fixed.

To adjust the focus manually

- 1** Select “Manual” in the Focus drop-down list.
- 2** Select “Focus Adjustment” and press the ENTER button.
- 3** Adjust the focus using the **▲**, **▼**, **◀** or **▶** button on the Remote Commander.
To focus on a distant subject, press the **▶** button.
To focus on a near subject, press the **◀** button.



Selecting the Input Picture and Sound

You can switch the picture displayed on the monitor screen, and switch between the input picture and audio.

Switching the Displayed Picture between the Local and Remote Pictures

When the displayed picture on the monitor can be switched during communication, pressing the LAYOUT button on the Remote Commander displays the indication “F1: Switches the monitored picture between the remote and local sites.” at the bottom of the monitor.

Each press of the F1 button on the Remote Commander switches the displayed picture between those on the local and remote sites.

Selecting the Input Picture

- 1 Press the VIDEO INPUT button on the Remote Commander. The Video Input > Near menu appears.

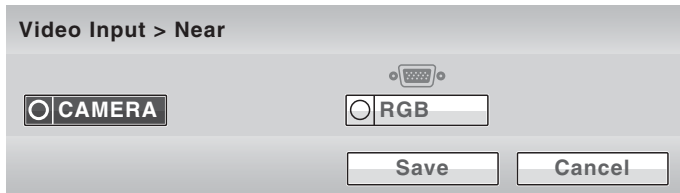

- 2 Use the **↑**, **↓**, **←** or **→** button on the Remote Commander to select the video input on the local site, then press the ENTER button. The picture input from the selected equipment is displayed on the monitor screen.

CAMERA: Selects the camera picture from the built-in camera.

RGB: Selects the picture from the equipment connected to the RGB IN connector.

- 3 To store the selected input in the memory of the system, use the **↑**, **↓**, **←** or **→** button on the Remote Commander to select “Save”, then press the ENTER button. The Video Input menu disappears. The stored video input is not deleted even after the system is turned off, and is selected when the power is turned on again.

To change the video input name displayed in the Video Input menu

You can label the desired name for each video input on the Custom Input Label page in the Video setup menu. When you switch the video input in step 2 above, the name you set is displayed in the Video Input menu. For example, you can label: Camera, None, etc.

For details, see “Custom Input Label” in the Video setup menu on page 65.

Selecting the Video Input Using the F1 to F4 (Function) Buttons on the Remote Commander

If you assign the video input (Camera or RGB) to any of the F1 to F4 buttons on the Remote Commander in “Function Keys in Communication” of the General setup menu, you can quickly switch the video input only by pressing one of the F1 to F4 buttons.

For details, see “Function Keys in Communication” in the General setup menu on page 75.

Switching the Sound to Be Sent to the Remote Party

You can switch the sound sent to the remote party between the sound from the microphone and that from the connected equipment. Use “Audio Input” in the Audio setup menu.

For details, see “Audio Input” in the Audio setup menu on page 62.

Switching Video and Audio at the Same Time

Set “Link to Audio Input” to “On” on the Link to Mic page of the Video setup menu. When you switch the video input, the audio input automatically switches to the one which has been set to link to the switched video input.

For details, see “Link to Audio Input” in the Video setup menu on page 65.



Switching the Picture from the Remote System

You can switch the picture output from the remote system during communication.

Press the VIDEO INPUT button, then F1 button on the Remote Commander. The Video Input > Far menu appears.

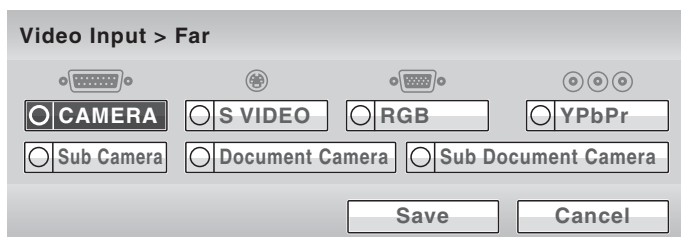

Use the **↑**, **↓**, **←** or **→** button on the Remote Commander to select the picture output from the equipment connected to the remote system, then press the ENTER button. The selected picture is input to the local system and is displayed on the monitor screen.

Note

You can only select the picture that can be output from the remote system.

Switching the Picture Displayed on the Monitor Screen

You can display the pictures on the local and remote sites on the monitor screen at the same time. This enables you to check how your own party is monitored on the remote site.

- 1 Press the LAYOUT button on the Remote Commander.
The Layout menu appears.

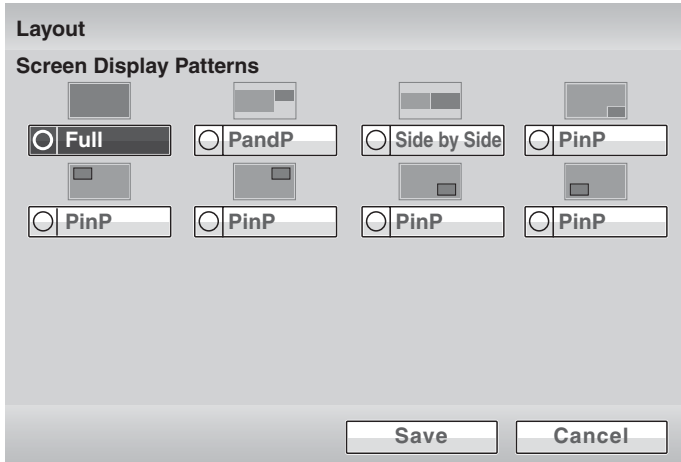

- 2 Use the **↑**, **↓**, **←** or **→** button on the Remote Commander to select one of the screen display patterns, then press the ENTER button.
You can select from among the following eight patterns:
Full: Displays the remote picture in full screen.
PandP: Displays the remote picture on the left of the screen in large size and the local picture on the right in small size.
Side by Side: Displays the remote and local pictures side by side.
PinP: Displays the local window picture in the remote full picture.
 You can select the location of the window picture from among five patterns.
- 3 To store the selected screen display pattern in the memory of the system, use the **↑**, **↓**, **←** or **→** button on the Remote Commander to select "Save", then press the ENTER button.
The Layout menu disappears.

To swap the location of the remote and local pictures

When the displayed picture can be switched during communication, pressing the LAYOUT button on the Remote Commander displays the indication “F1: Switches the monitored picture between the remote and local sites.” at the bottom of the monitor.

Each press of the F1 button on the Remote Commander swaps the location of both pictures.

To switch the display to the remote picture while receiving RGB pictures

When receiving an RGB computer picture from a remote party, pressing the LAYOUT button on the Remote Commander displays the indication “F2: Restores the previous monitor screen.” at the bottom of the monitor. Press the F2 button on the Remote Commander to switch to the remote picture. To return to the RGB picture, press the F2 button again.

Note

When you connect an external monitor and set “Monitor Output” to “Dual” in the Video setup menu, you cannot switch to RGB picture by pressing the F2 button.

Capturing the Screen

You can capture the image displayed on the screen by using “Screen Capture” in the Tools menu and display the captured image on the Phone Book. The captured image is stored in the “Memory Stick”.

To capture the local image

- 1 Insert a “Memory Stick” in which you want to save the capturing image into the Memory Stick slot on the Communication System.
- 2 Display the image you want to capture on the monitor screen.
For details on adjusting the camera, see “Adjusting the Camera” on page 125.
- 3 Press the TOOLS button on the Remote Commander, or press the **↑**, **↓**, **←** or **→** button to select “Tools” in the Home menu and press the ENTER button.
The Tools menu appears.
- 4 Press the **→** button on the Remote Commander, and select “Execute” for “Screen Capture” with the **↑**, **↓**, **←** or **→** button then press the ENTER button.

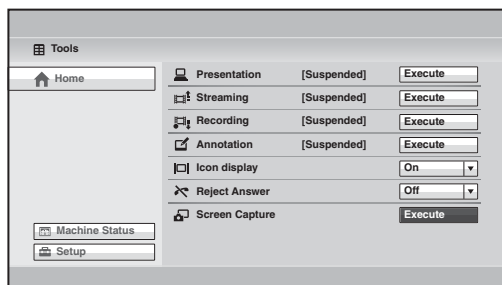

The image displayed on the monitor is captured and stored in the “Memory Stick”.

For the procedure how to display the captured image on the Phone Book, see “Registering a New Remote Party” on page 112.

To capture the remote image

- 1 Display the image of the remote site you want to capture on the monitor screen during communication.

For details on adjusting the remote camera, see “Adjusting the Camera” on page 125.

- 2** Press the TOOLS button on the Remote Commander to display the Tools menu.
- 3** Use the **↑**, **↓**, **←** or **→** button on the Remote Commander to select “Execute” for “Screen Capture”, then press the ENTER button.
The remote picture is captured and is stored in the “Memory Stick”.

Chapter 4: Connection with Optional Equipment

This chapter describes the various connections using the optional equipment in addition to the components contained in the PCS-XL55 HD Visual Communication System.

To make a multipoint connection, see Chapter 6.

Using a Tools Menu

Pressing the TOOLS button on the Remote Commander opens the Tools menu on the monitor screen.

The Tools menu allows you to perform operations often used simply by selecting the item in the menu.

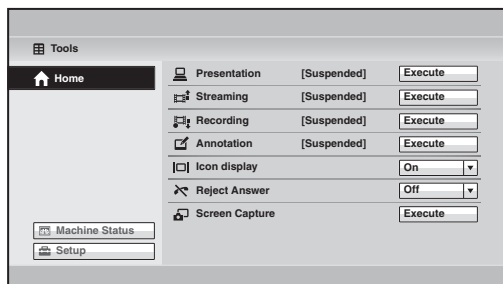

Pressing the **▶** button on the Remote Commander, selecting each item with the **▲**, **▼**, **◀** or **▶** button and pressing the ENTER button enable the following operations:

Note

“Presentation” is displayed only when the PCSA-DSG80 HD Data Solution software (not supplied) is installed in the Communication System.

Presentation

Pressing the ENTER button on the Remote Commander allows you to transmit an RGB picture input from a connected computer to a remote party. During

transmission, the message “Executing” appears and the selectable item changes to “Stop”. To stop transmitting the RGB picture, select “Stop” and press the ENTER button.

For details on presentation, see “Using the Computer Picture for Presentation” on page 141.

Streaming

Pressing the ENTER button on the Remote Commander allows you to broadcast live stream of the visual communication, and people who do not participate in the communication can watch it over the Web. During broadcasting, the message “Executing” appears and the selectable menu item changes “Stop”. To stop broadcasting a live stream, select “Stop” and press the ENTER button.

For details, see “Streaming a Communication” on page 144.

Recording

Pressing the ENTER button on the Remote Commander allows you to save the video and audio of the visual communication in progress in a “Memory Stick”. While the recording is being saved, the message “Executing” appears and the selectable menu item changes to “Stop”. Selecting “Stop” and pressing the ENTER button stops recording.

For details on recording, see “Recording a Visual Communication” on page 146.

Annotation

Pressing the ENTER button displays the Annotation Start menu. You can transmit the picture with letters and graphics overwritten with a commercially available pen tablet or display a pointer on the screen (Annotation function). While the annotation function is being executed, the message “Executing” appears and the selectable menu item changes to “Stop”. Selecting “Stop” and pressing the ENTER button ends annotation.

For details on annotation, see “Using the Annotation Function” on page 148.

Icon Display

Pressing the ENTER button on the Remote Commander and selecting “On” with the **▲**, **▼**, **◀** or **▶** button display the indicators on the screen. Selecting “Off” hides the indicators.

Reject Answer

Pressing the ENTER button and selecting “On” with the **▲**, **▼**, **◀** or **▶** button enables you to reject incoming calls from other terminals during communication. Selecting “Off” results in accepting the incoming calls.

Screen Capture

Pressing the ENTER button on the Remote Commander allows you to save the picture displayed on the screen in a “Memory Stick” as a still image.

For details on screen capture, see “Capturing the Screen” on page 137.

Using the Computer Picture for Presentation

If you install the optional PCSA-DSG80 HD Data Solution software in your system, you can transmit an RGB picture input from a computer, etc. with the local picture simultaneously to a remote party.

Notes

- You can receive a computer picture transmitted from the remote party even if the PCSA-DSG80 HD Data Solution software is not installed.
- The acceptable RGB signals differ depending on whether they are transmitted during presentation mode or computer display mode.

For details on acceptable RGB signals, see “PCS-XL55 HD Visual Communication System (RGB IN)” on page 231.

Installing the HD Data Solution Software

- 1 Turn off the Communication System.
- 2 Insert the Key Module of the HD Data Solution software into the TABLET connector.

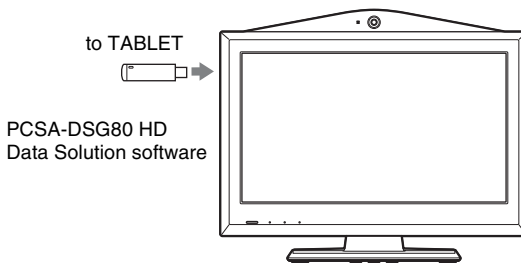

- 3 Press the I/⏻ (power) switch on the Communication System to turn it on. The PCSA-DSG80 HD Data Solution software is installed in the System.
- 4 Turn off the Communication System.
- 5 Remove the Key Module of the HD Data Solution software from the TABLET connector.
- 6 Press the I/⏻ (power) switch on the Communication System to turn it on. The installed software will appear under “Software Option” on the Machine Information page of the Machine Status menu.

Connecting a Computer

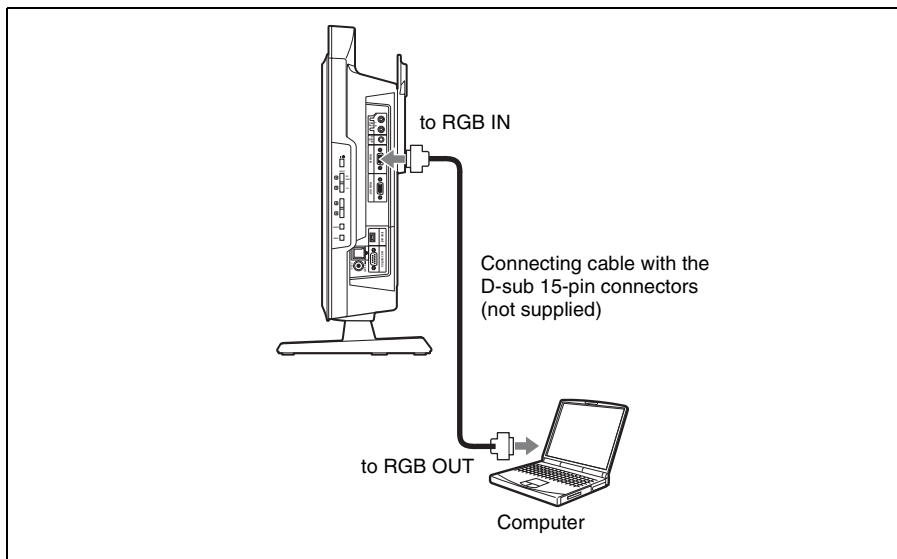

Making a Presentation

To configure the presentation mode

When you transmit an RGB picture from a computer, etc. and a camera picture simultaneously to a remote party, the remote party can view both pictures simultaneously. This function is called “to make a presentation using the presentation mode complying with H.239”. Using this function allows smooth reproduction of both camera and computer pictures. To make a presentation using the presentation mode complying with H.239, it is necessary to turn on the presentation mode on both the local and remote systems. If the presentation mode on either of the systems is turned off, a presentation complying with H.239 cannot be made.

To configure the presentation mode, set “H.239” to “On” on the IP: Mode page (page 59) or on the ISDN: Mode page (page 61) of the Communication setup menu.

To start a presentation

- 1** Press the TOOLS button on the Remote Commander to open the Tools menu.
- 2** Press the **▶** button on the Remote Commander and press the **▲**, **▼**, **◀** or **▶** button to select “Execute” for “Presentation”.

The RGB picture from the computer is transmitted to the remote party. While presentation is being executed, the message “Executing” appears on the screen.

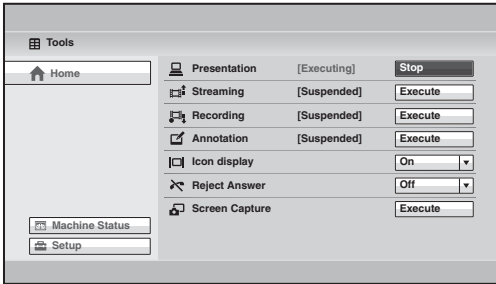

Note

You can also transmit the computer picture to the remote party by pressing the PRESENTATION button on the Remote Commander instead of performing steps 1 and 2 above.

To change the display pattern of the presentation when the H.239 function is disabled

Select the display pattern for the presentation with “Presentation Screen” on the Basic Setup page of the Video setup menu (page 65) before starting a presentation.

Full Screen: The computer picture to be transmitted from the local system is displayed in full screen.

PandP: The computer picture to be transmitted from the local system and the selected input picture (local camera picture, etc.) are displayed in PandP mode.

Side by Side: The computer picture to be transmitted from the local system and the selected input picture (local camera picture, etc.) are displayed in Side by Side mode.

Note

If the remote system does not support H.239, you cannot transmit the input picture (camera picture, etc.) and the computer picture as two streams, even if “H.239” is set to “On” on your system.

To stop the presentation

Select “Stop” for “Presentation” in the Tools menu and press the ENTER button on the Remote Commander. Transmission of the computer picture stops.

You can also stop the presentation by pressing the PRESENTATION button on the Remote Commander.

Streaming a Communication

By broadcasting a stream of a visual communication, people who cannot attend the communication can watch the proceedings over the Web using a computer.

Before broadcasting a live stream, be sure to configure the live stream permission setting.

For details on viewing a streamed communication, see “Chapter 8: Web Control Function”.

For details on the streaming settings, see “Streaming” on the Streaming/Recording page of the Administrator setup menu on page 80.

Starting a streaming broadcast

- 1 Press the TOOLS button on the Remote Commander to open the Tools menu.
- 2 Press the **▶** button on the Remote Commander and press the **▲**, **▼**, **◀** or **▶** button to select “Execute” for “Streaming”, then press the ENTER button. The streaming broadcast starts, and the communication in progress can be watched from a computer over the Web. While the streaming broadcast is running, the message “Streaming [Executing]” is displayed in the Tools menu and the menu item changes to “Stop”.

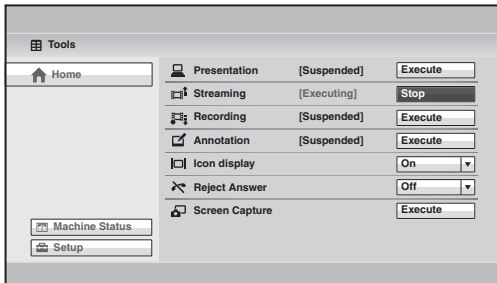

Notes

- If you start streaming before a communication begins, the broadcast will continue streaming after the communication begins.
- Depending on Web access limitations, about 10 terminals can view a streaming broadcast simultaneously. The actual number of terminals that can view the broadcast simultaneously depends on your system’s operating environment.

To stop a streaming broadcast

Selecting “Stop” for “Streaming” in the Tools menu and pressing the ENTER button stop the streaming broadcast.

Notes

- Even if the Communication System is turned off while the streaming broadcast is being executed, the streaming broadcast continues.
- The streaming broadcast cannot be executed during encrypted connection.

Recording a Visual Communication

The video and audio of a visual communication can be saved in a “Memory Stick” in MPEG4 format. The saved data can then be viewed on a computer.

For details on the recording settings, see “Recording” on the “Streaming/Recording” page of the Administrator setup menu on page 80.

To start recording

- 1 Insert a “Memory Stick” into the Memory Stick slot.

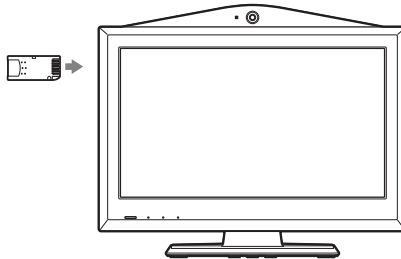

- 2 Press the TOOLS button on the Remote Commander to open the Tools menu.
- 3 Press the **▶** button on the Remote Commander and press the **▲**, **▼**, **◀** or **▶** button to select “Execute” for “Recording”, then press the ENTER button. The message “Start recording?” appears.
- 4 Use the **▲**, **▼**, **◀** or **▶** button on the Remote Commander to select “OK”, then press the ENTER button.

Recording in the “Memory Stick” starts.
During recording, the message “Recording [Executing]” is displayed in the Tools menu and the menu item changes to “Stop”.

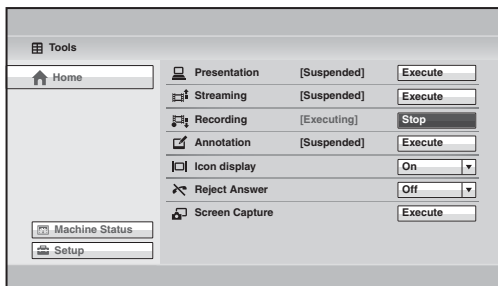

To stop recording

- 1 Select “Stop” for “Recording” in the Tools menu, then press the ENTER button on the Remote Commander.
The message “Stop recording?” appears.
- 2 Use the **↑**, **↓**, **←** or **→** button on the Remote Commander to select “OK”, then press the ENTER button.
Recording in the “Memory Stick” stops.

Notes

- If the remaining capacity of the “Memory Stick” is no longer enough for storage during recording, the recording stops automatically and a notification message appears.
- Although the recorded MPEG4 files have the same file type name as the MPEG4 files that can be played on the PSP or other devices that support the “Memory Stick” video format, you cannot play the files on these devices even after the files are recognized and moved to the file directories of these devices.
- Recording cannot be executed during encrypted connection.

Using the Annotation Function

During communication you can transmit or receive letters and graphics written on the screen with a pen tablet as they are written. You can also point the camera picture or computer picture with a pointer. This function is called “Annotation”.

The annotation function supports the Bamboo small CTH-470/K0* pen tablet from Wacom Co., Ltd.

* Wacom and the Wacom logo are registered trademarks of Wacom Co., Ltd. Bamboo is a trademark.

For details on the Bamboo small CTH-470/K0, consult with a Sony dealer.

Note

The communication using a pen tablet is only available for communication between the PCS-XG80/XG80S/XG55/XG55S/XA80/XA55/XL55/G60/G60D/G60DP Communication Systems. A pen tablet cannot be used for communication with other Sony communication systems.

Connecting a Pen Tablet

- 1 Turn off the Communication System.
- 2 Connect the pen tablet to the TABLET connector on the left side of the Communication System.

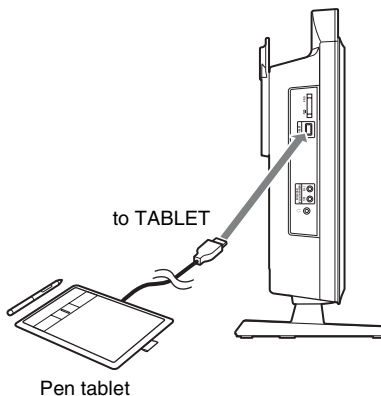

- 3 Press the I/O (power) switch on the Communication System to turn it on.

Using the Annotation Function while in Communication

To start annotation

- 1 Start communication.
- 2 Press the TOOLS button on the Remote Commander to open the Tools menu.
- 3 Press the \rightarrow button on the Remote Commander and press the \uparrow , \downarrow , \leftarrow or \rightarrow button to select “Execute” for “Annotation”, then press the ENTER button.

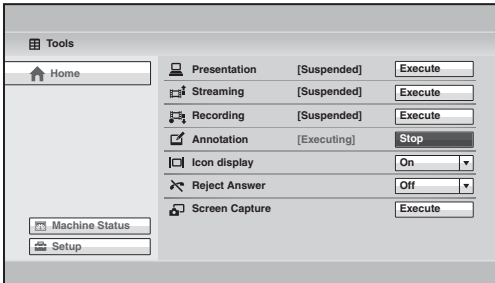

The Annotation Start menu appears.

- 4 Use the \uparrow , \downarrow , \leftarrow or \rightarrow button on the Remote Commander to select “Background Screen” for executing the annotation function and press the ENTER button.

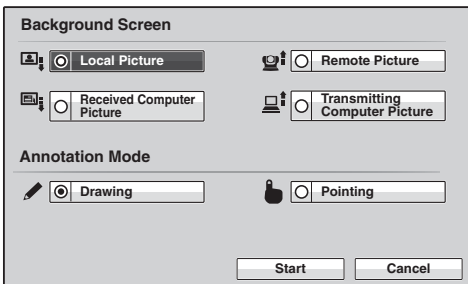

Remote Picture: Selects the picture on the remote site as the background

Local Picture: Selects the picture on the local site as the background

Received Computer Picture: Selects the computer picture received from the remote site as the background

Transmitting Computer Picture: Selects the computer picture on the local site as the background

Notes

- “Received Computer Picture” can be selected only when the computer picture is being received from the remote site.
- “Transmitting Computer Picture” can be selected only when the computer picture is being transmitted from the local site.



5 Use the **↑**, **↓**, **←** or **→** button on the Remote Commander to select “Annotation Mode” and press the ENTER button.

Drawing: Allows you to write letters or graphics on the screen.

Pointing: Allows display of a pointer on the screen.

6 Use the **↑**, **↓**, **←** or **→** button on the Remote Commander to select “Start” and press the ENTER button.

The **NEAR** indicator indicating that the local party uses annotation appears.

When the Drawing mode is selected,  (pen) indicator appears on the monitor screen and  (pointer) appears when the Pointing mode is selected.



7 Write letters or graphics on the screen using a pen supplied with the pen tablet or your finger, or move the pointer on the screen.

The written data is displayed on the screen in live.

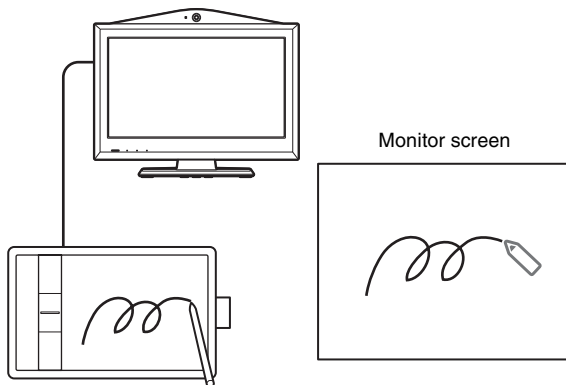

For details on how to use the pen tablet, refer to the instruction manual supplied with the pen tablet.

Operations during pointing

You can point to any desired portion on the monitor screen with a pointer. You cannot write letters and graphics in pointing mode.

Operations during drawing

Operate using the function keys on the tablet and the buttons on the pen.

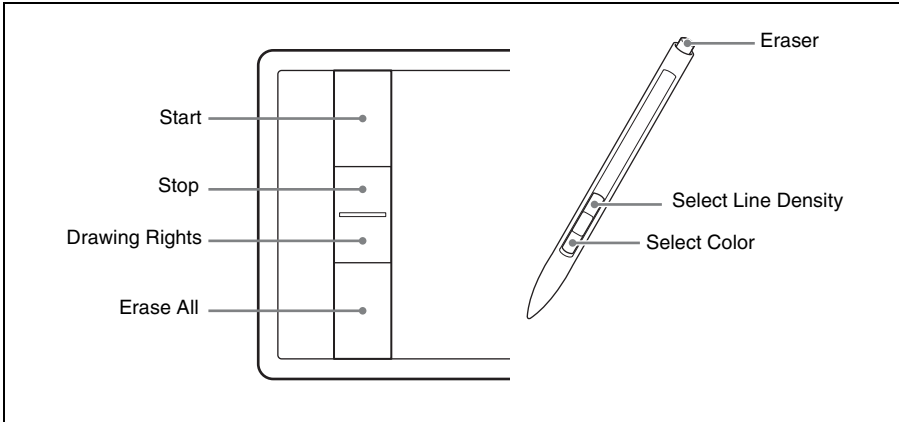

To start drawing

Press the topmost key on the tablet.

To stop drawing

Press the second key from the top on the tablet.

To change the color

Press the lower pen button. Each press changes the color. You can select from among black, red, blue, green, yellow, orange, purple and white.

To perform this using touch operations, place one finger on the tablet screen, and tap to the right of that position with a second finger.

To change the line density

Press the upper pen button. Each press changes the line density. You can select from three different line densities.

To perform this using touch operations, place one finger on the tablet screen, and tap to the left of that position with a second finger.

To erase with the eraser

Touch the tail switch (eraser) of the pen onto the tablet and move it on the letters or graphics you want to erase.

To perform this using touch operations, touch the tablet screen with two fingers, and perform the operation using the balls of your fingers.

To erase all written letters and graphics

Press the bottommost key on the tablet.

To obtain the drawing rights





Normally, the drawing rights belong to the party who starts annotation. In the case that the remote party starts annotation, the Obtain Drawing Rights button appears and the  indicator (Drawing executed by the remote party) on the monitor screen on the local site.

If you want to obtain the drawing rights, press the second key from the bottom on the tablet. The  indicator (Drawing executed by the local party) appears on the monitor screen, and you are allowed to write letters and graphics on the screen.

To save the drawings written using annotation

- 1** Insert a “Memory Stick” in which you want to save the drawings using annotation into the Communication System.
- 2** Press the TOOLS button on the Remote Commander to open the Tools menu.
- 3** Select “Execute” for “Screen Capture” in the Tools menu.
The drawing using annotation on the screen is saved in the “Memory Stick” as a still image.

To end the annotation mode

- 1** Press the TOOLS button on the Remote Commander to open the Tools menu.
- 2** Use the , ,  or  button on the Remote Commander to select “Stop” for “Annotation”, then press the ENTER button.
The annotation mode ends.
The letters and graphics written using the annotation function are deleted when the communication ends.

Using External Microphones and Headphones

The built-in microphone is intended for personal use. The PCS-A1 (not supplied) and PCSA-A3 (not supplied) microphones can also be connected. You can input the stereo sound from two PCS-A1 (not supplied) or PCSA-A3 (not supplied) microphones to the system. You can also connect headphones or headsets to the system.

To connect the microphones and headphones

Connect the optional microphones to the MIC (A1/A3) 1 (R) and 2 (L) jacks and the headphones to the  (headphone) jack on the Communication System. Power is supplied to the microphones from the system.

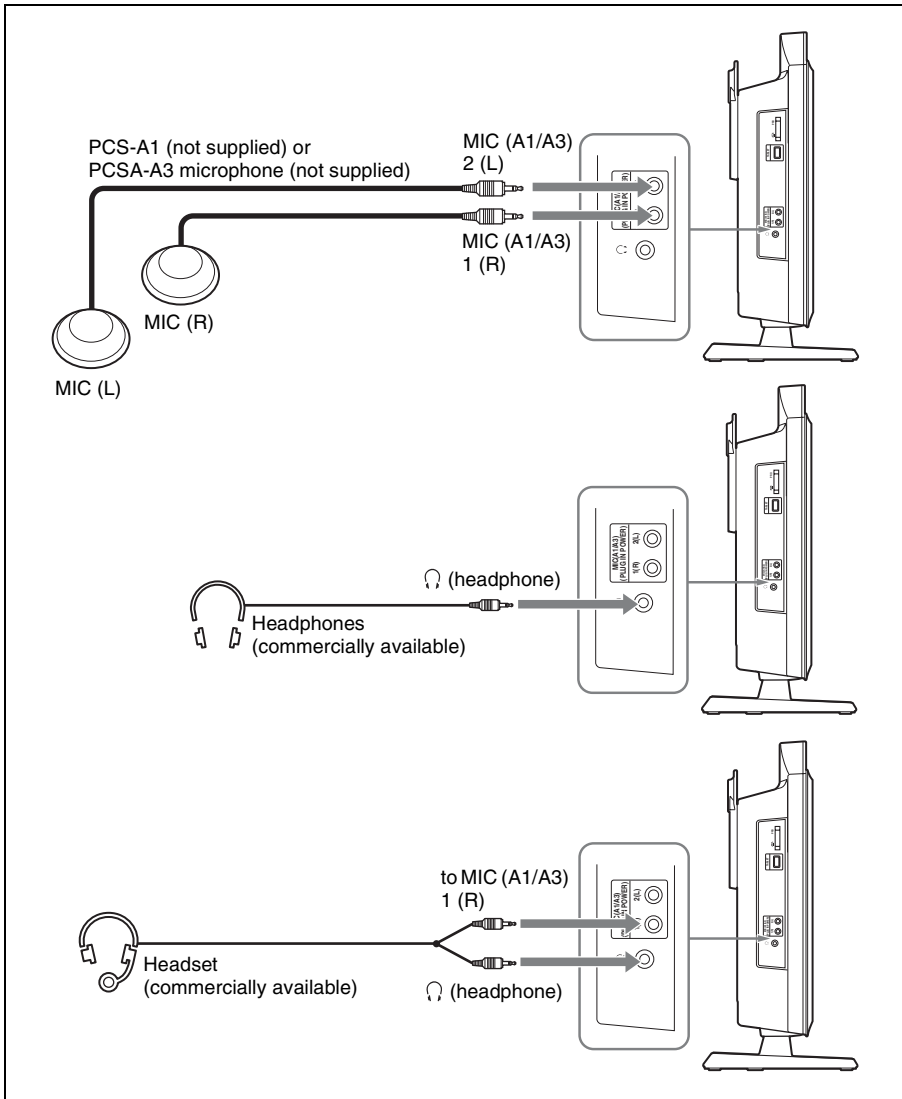

To use the connected microphones

Set “Audio Input” to “MIC” on the Basic Setup1 page of the Audio setup menu, and set “Input Select (MIC)” to “MIC (A1/A3)” (page 62). To input the stereo sound from two microphones, set “Input Mode” to “Stereo” (page 63). Set it to “Monaural” to input monaural sound from two microphones.

Notes on installation of the microphones

- Install microphone about 50 cm (1.6 ft) away from the participants.
- Place the microphone in a quiet, echo-free location.
- Install microphones away from equipment that may cause noise.
- Avoid covering the microphones, with paper for example, or carrying the microphones and moving them. If you do either, extreme noise and echo may be heard temporarily by the remote party. In this case, wait until the echo disappears.
- When stereo sound is input, locate the microphone connected to the MIC (A1/A3) 1 (R) jack on the right of the camera and the microphone connected to the MIC (A1/A3) 2 (L) jack on the left.

Microphone layout examples

PCS-A1 microphones

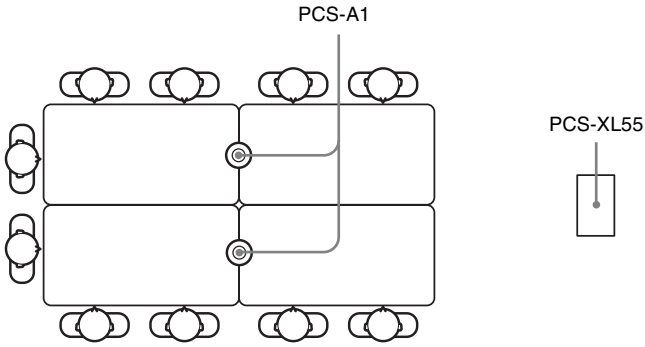

PCSA-A3 microphones

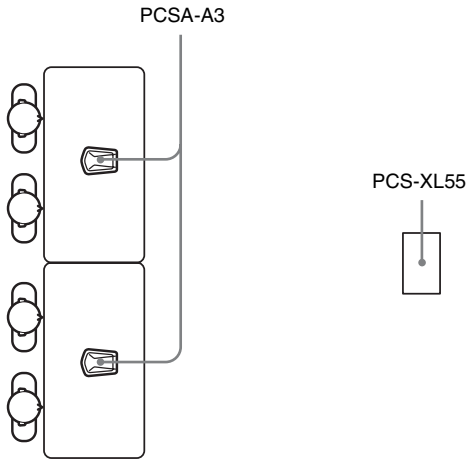

Recording during a Communication

You can record the voices of participants on both the remote and local sites during a communication if you connect an audio recorder to the REC OUT jack on the Communication System.

This is convenient for taking minutes of the communication.

To connect an audio recorder

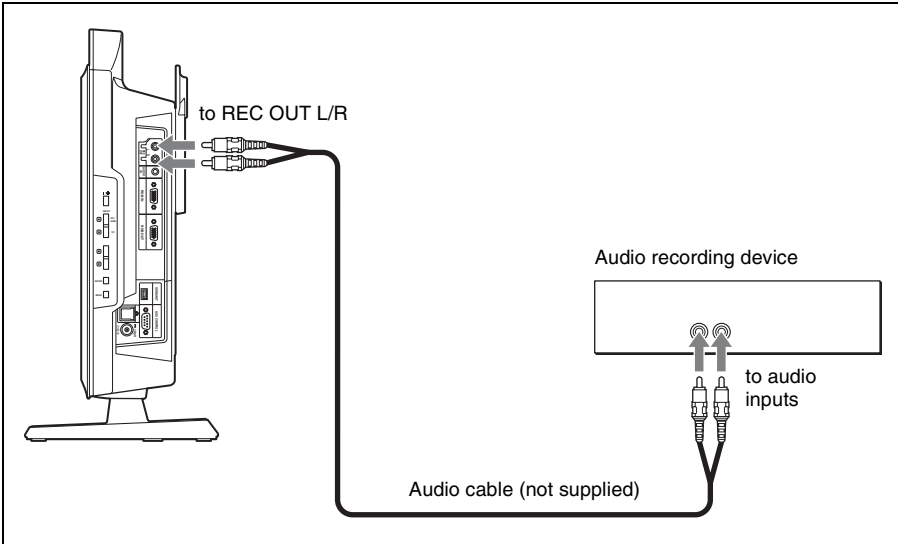

When recording with an audio recorder

When an audio recorder is connected to both the AUDIO IN and REC OUT jacks, set "Recording Mute" to "On" on the Basic Setup1 page of the Audio setup menu, since the echo may cause and is transmitted to a remote party (page 62).

To record the sound output from the REC OUT L/R jacks in 2-channel monaural, set "REC OUT Mode" to "Monaural 2ch" on the Basic Setup2 page of the Audio setup menu.

Sending Audio/Video from the External Equipment to a Remote Party

The Communication System allows you to send the picture and sound output from a connected computer, for example, to a remote party.

To connect the video equipment for input

The Communication System can be connected to RGB video equipment.

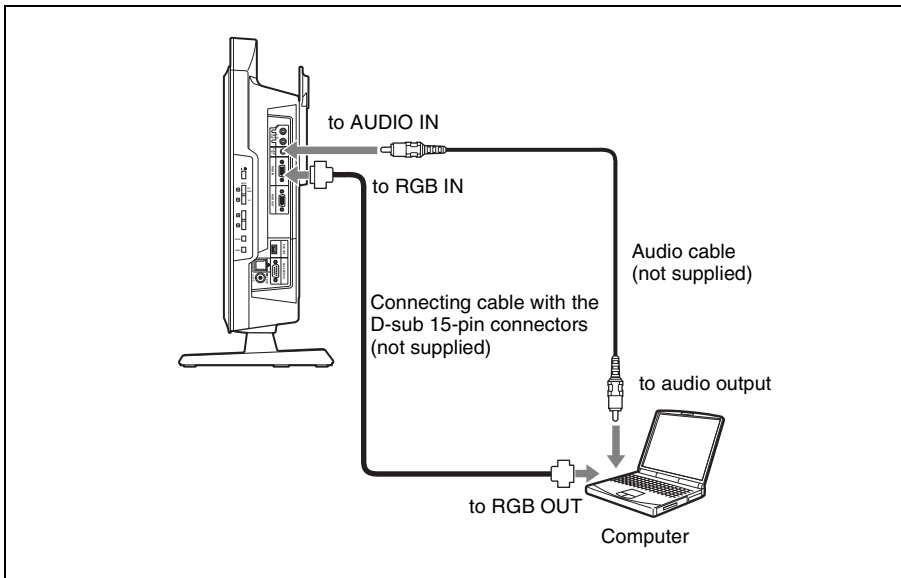

To input audio/video from external equipment

To input video

Press the VIDEO INPUT button on the Remote Commander to open the Video Input >Near menu, then select the video you want to input.



Use the **↑**, **↓**, **←** or **→** button on the Remote Commander to select the external equipment connected to each video input on the Communication System, then press the ENTER button.

The picture from the selected equipment is displayed.

CAMERA: Video from the built-in camera.

RGB: Video of a computer, etc. connected to the RGB IN connector.

To save the selected input, press the **▲**, **▼**, **◀** or **▶** button on the Remote Commander to select “Save”, then press the ENTER button.

To input audio

Set “Audio Input” to “AUX” or “MIC+AUX” on the Basic Setup1 page of the Audio setup menu (page 62).

When set to “AUX”, the sound from the external equipment is input and the sound from a microphone is deactivated. When set to “MIC+AUX”, both sounds are input.

To switch to the sound from the external equipment connected to the AUDIO IN jack, set “Input Select (AUX)” to “AUDIO” on the Basic Setup1 page of the Audio setup menu (page 63).

To switch the input video and audio at the same time

Set “Link to Audio Input” to “On” on the Link to Mic page of the Video setup menu (page 65) so as to link the audio you want to switch at the same time with the video input.

When the video input is switched, the audio input is simultaneously switched to the one linked to the video input.

Viewing the Picture from the System on a Monitor or Projector

When the monitor or projector is connected to the Communication System, you can view the picture from the system.

To connect a monitor or projector

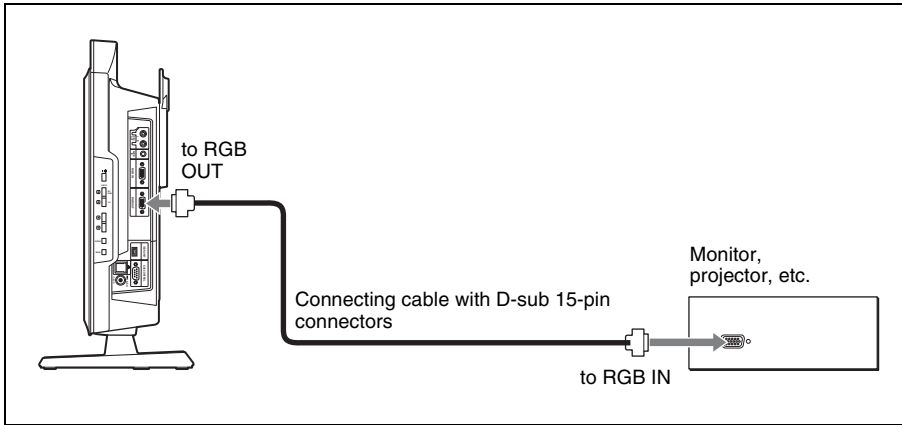

To use the connected display equipment

When outputting the picture both to the monitor of the Communication System and the display equipment connected to the RGB OUT connector, set "Monitor Output" to "Dual" on the Basic Setup page of the Video setup menu (page 65). For RGB output, you can select the video format of the signal output from the RGB OUT connector with "RGB Monitor Output Format". You can select "SXGA", "XGA" or "WXGA" (page 65).

Pictures displayed on the two monitors

During communication, the following images are displayed on the two monitors.

Picture displayed on the monitor of the Communication System

The local or remote picture shot by the camera (moving picture) is monitored on the monitor of the Communication System.

To switch between the local and remote pictures, press the LAYOUT button, then F1 button on the Remote Commander.

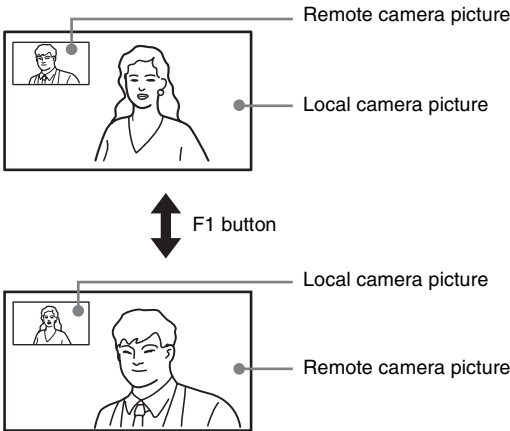

Picture displayed on an external monitor

The picture shot by the local camera or the RGB picture transmitted from the remote party can be displayed on an external monitor connected to the RGB OUT connector.

Communicating without the Picture – Voice Meeting

The Visual Communication System enables a voice only communication using telephones via an ISDN line. (Voice Meeting)

Basic connecting procedures are the same as those for normal communication with audio/video.

Note

If “Lens Cover Mic On/Off Function” is set to “On”, the microphone will turn off when the lens cover is closed.

Conducting a voice meeting with a remote party not registered in the phone book

Set “Line I/F” to “TEL” in the Detailed Dial menu.

During the Voice Meeting, the “Voice Only” indicator is displayed.

For “Line I/F” setting, see “Calling a Remote Party Not Registered in the Phone Book” on page 105.

To register a remote party for a Voice Meeting

Set “Line I/F” to “TEL” in the List Edit menu displayed from the Phone Book.

For registration, see “Registering a Remote Party – Phone Book” on page 112.

To set the audio compression format

Select the audio compression format by setting “Telephone Mode” of the Dial setup menu.

When you initiate the voice meeting, set “Telephone Mode” to “Auto” (page 57). When set to “Auto”, the G.711 μ -law format is automatically selected.

You need not set the audio compression format when receiving a call for a Voice Meeting from the remote party.

Controlling the Remote System with the Tone Signal – DTMF Transmission

The Visual Communication System enables you to control the remote system connected by transmitting the tone signal (DTMF: Dual Tone Multi Frequency) assigned to the numbers for dialing (0-9, #, *).

- 1** Press the TONE (*) button on the Remote Commander during communication.
The DTMF menu appears on the monitor screen.
- 2** Press one of the number buttons (0-9, #, *) on the Remote Commander corresponding to the tone signal you want to transmit to the remote party.
The tone signal will be transmitted when the button is pressed.
- 3** To stop transmitting the tone signal, press the ENTER button on the Remote Commander.
The DTMF menu disappears.

Note

The microphone is automatically turned off while the DTMF menu is displayed.

Accessing the Communication System

The following controls are available to access the Communication System. For details on each control, consult your Sony dealer.

Note

Depending on the operating environment, unauthorized third parties on the network may be able to access the system. When allowing external access, be sure to configure all of the passwords on the Password page (page 77) of the Administrator setup menu.

Using a Web Browser

You can control or set up the Communication System by accessing it from a Web browser.

To access the Communication System from a Web browser, set “Web Monitor” to “On” and “Web Access” to “Enabled” on the Access Permit page of the Administrator setup menu (page 80).

For details on Web operation, see “Chapter 8: Web Control Function”.

Using Telnet

You can control or set up the Communication System by accessing it with Telnet.

To access the Communication System from Telnet, set “Telnet Access” to “Enabled” on the Access Permit page of the Administrator setup menu (page 80).

Using SSH

You can control or set up the Communication System by accessing it with SSH.

To access the Communication System from SSH, set “SSH Access” to “Enabled” on the Access Permit page of the Administrator setup menu (page 81).

Chapter 5: Encrypted Connection

When a strictly confidential communication is required, the communication system enables a connection with encrypted video and audio. A connection conducted using this feature is known as an encrypted connection.

This chapter describes how to conduct an encrypted connection.

The Communication System is equipped with standard encryption, which complies with the H.233, H.234 and H.235 standardized by the ITU-T.

Notes

- Streaming and recording are not available during an encrypted connection.
- The maximum bandwidth for encrypted connections is 6 Mbps.

Preparing for an Encrypted Connection via LAN

To start an encrypted connection, “Encryption Mode” must be set in the Encryption setup menu.

Set “Encryption Mode” to “Connect Priority” or “Encrypt Priority” in the Encryption setup menu.

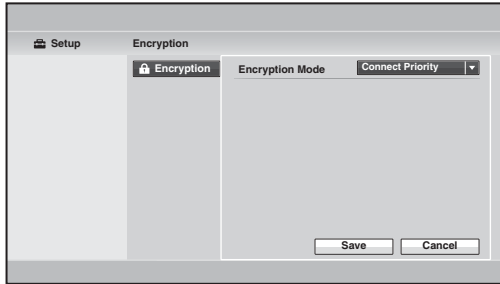

Connect Priority

Connects with encryption to a remote party with standard encrypted connection enabled. Connects without encryption to parties unable to connect with standard encryption or parties with encryption set to off.

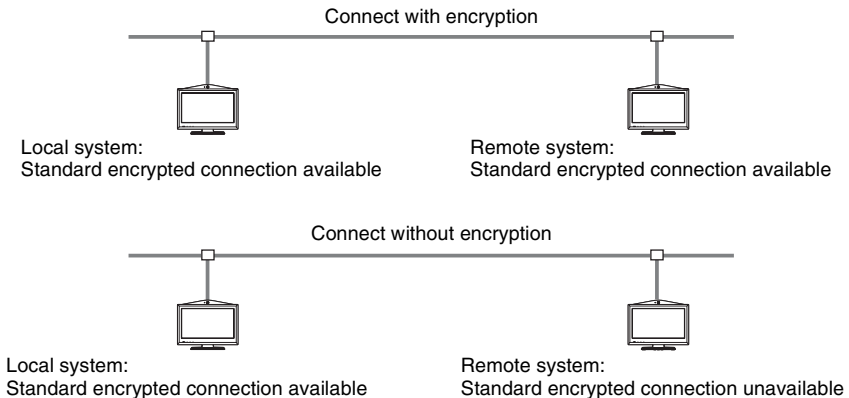

Encrypt Priority

Connects only to remote parties with standard encrypted connection enabled.

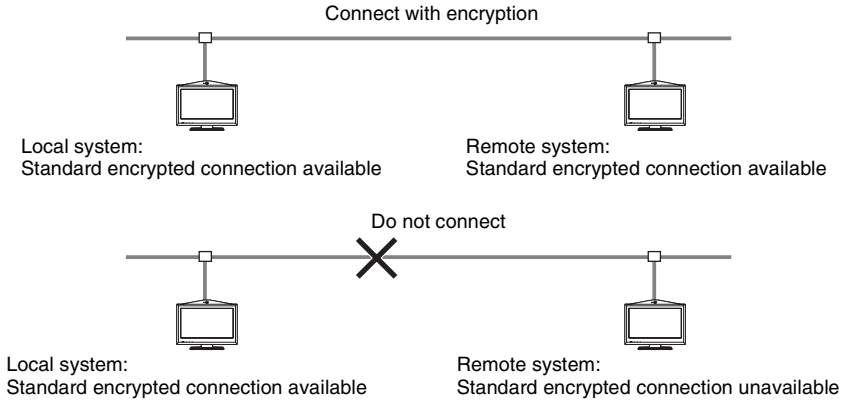

Starting an Encrypted Connection

You can start an encrypted connection by calling a remote party in the same manner as a daily connection.

During an encrypted connection, the encryption icon, , is displayed.



Note

If there is no icon displayed, transmitted and received data are not encrypted. Confirm if an icon is displayed before starting a connection.

When the encrypted connection is disabled

If the following message appears when you call a remote party, an encrypted connection is not available.

Error Messages	Causes
The far-end system is not compatible with the encryption feature.	The remote system is not equipped with an encryption feature.
The encryption feature on a far-end system is disabled.	The encryption feature on a remote system is turned off or the signal encryption method setting on the remote system is different from that on the local system.
The encryption feature on a far-end system is enabled.	The encryption feature on a remote system is turned on.
The conference could not start because the encryption feature at the near-end side was disabled.	“Encryption Mode” is set to “Off” on the local system.
The conference could not start because the encryption feature at the far-end side was disabled.	The encryption feature on the remote system is disabled.
The conference could not start because the signal encryption method at the near-end side differed from that of the far-end side.	The encryption method setting on the remote system is not the same as that on the local system.

Error Messages	Causes
The standard encryption videoconference with SIP connection is not available.	You are connected to the remote system via SIP connection.



Chapter 6: Multipoint Connection

This chapter describes how to connect your system to multiple points. When connecting via a LAN, multipoint connection among up to 3 points including your site is available. When connecting via an ISDN, multipoint connection among up to 3 points including your site is available. A multipoint connection using LAN and ISDN mixed is also available.

Restrictions on the use of the MCU software

- When a multipoint connection is made via LAN, you can set up the total communication bit rate for all the connecting points with “Total Bandwidth” in the Communication setup menu. As the communication bit rate for each point is automatically adjusted so as not to exceed the value selected in “Total Bandwidth”, actual bit rate per point may differ from that selected for that point.
- When a multipoint connection is made via an ISDN, the same number of channels should be used on all the points and the total channels must not exceed 12B.
- The H.264, H.263+ and H.261 video modes are supported. However, H.264 High Profile is not supported. In addition, connection in 1080 Mode is not supported.
- The G.711, G.722, G.728 and MPEG4 AAC audio modes are supported.
- A multipoint connection including a SIP connection is not available.
- Cannot be used as the main terminal in a cascade connection.

Connection Examples of a Multipoint Connection

Using the LAN Connection (Up to 3 Points)

- Multipoint connection for up to 3 points is available.
- If you have already made a point-to-point connection when a third point calls, the system automatically starts multipoint connection.

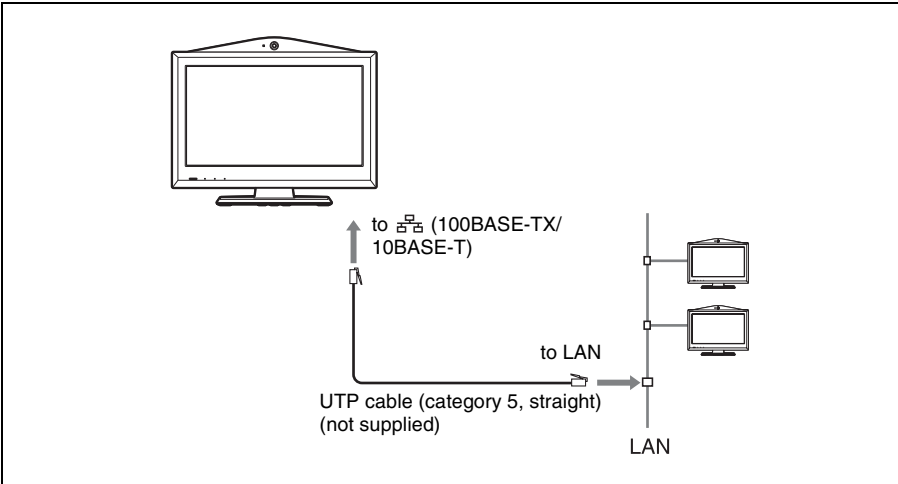

Using the ISDN Connection

Multipoint connection for up to 3 points is available by using the optional PCSA-B384S or PCSA-B768S ISDN Unit.

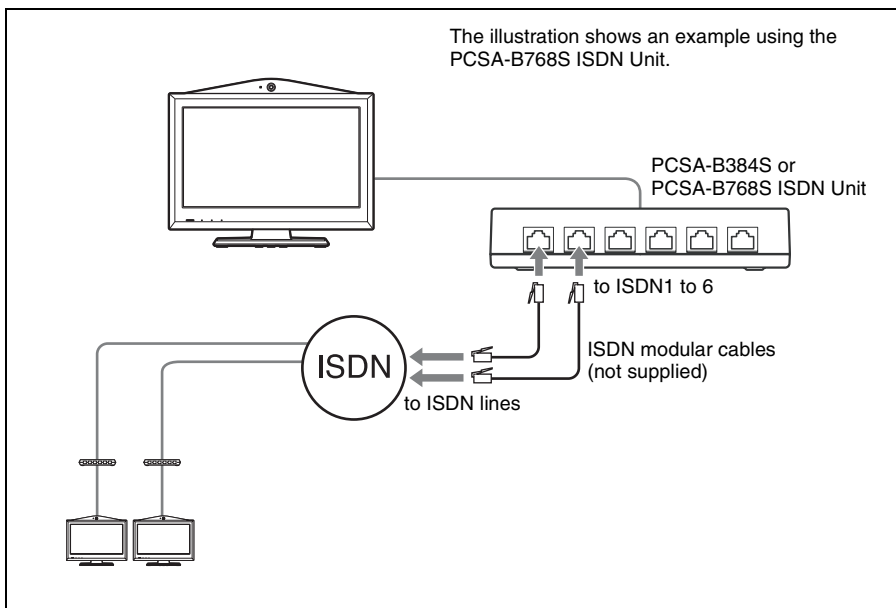

Notes on the number of ISDN lines used and number of remote parties for a multipoint connection

You can select the number of ISDN channels to be used for the remote point connected first using “ISDN Bandwidth” on the ISDN: Mode page of the Communication setup menu (page 61).

However, if the number of remote points connected increases as a result of dialing from the main terminal, some of the channels used for the first point will be cut off and used for newly connected points instead. For example, if you use six ISDN lines (up to 12B channels available), 12B channels will be used for the first remote point only when no other points are connected. When the system connects to a second point, the number of channels for the first point decreases, and 6B channels will be used for both the first and second points.

Even if one of the remote points in a multipoint connection is disconnected, the number of channels used for the remaining points will not increase.

Note

When you are called from a remote party and the remote party has set up a lower number of ISDN channels than that in your terminal, the setting on the remote party’s terminal has priority.

To connect with a normal phone

When you are using an ISDN connection, a normal phone can be connected at up to 3 points.

Only the 1B (64K) connection is available for a normal phone.

Using Both LAN and ISDN

Multipoint connection with terminals connected via a LAN and ISDN is available.

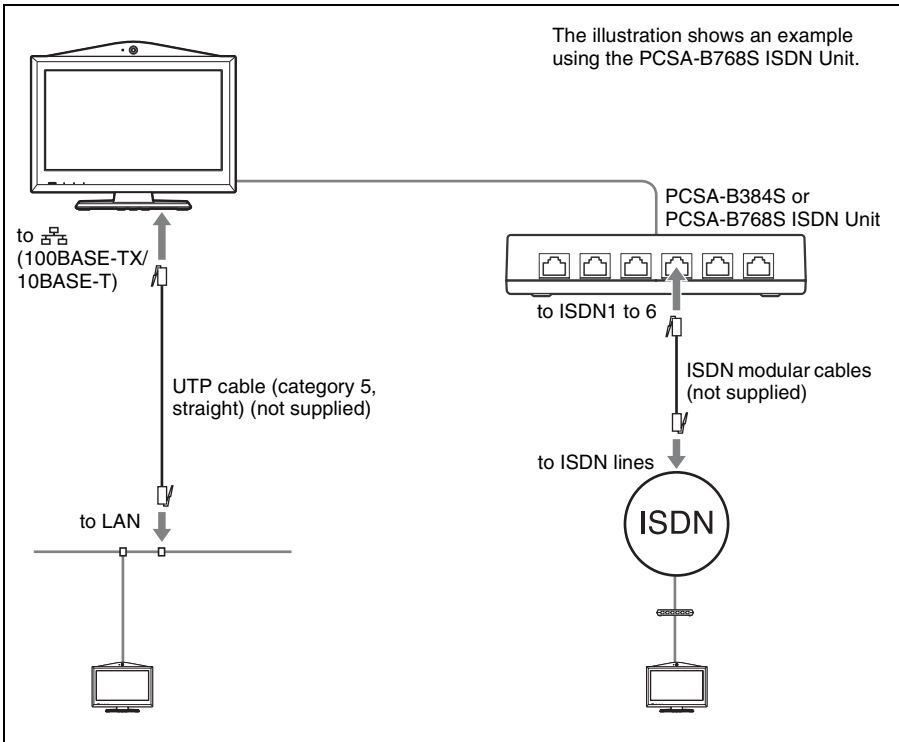

Configuring Multipoint

Setting Up Multipoint

- 1 Open the Multipoint setup menu, set “Multipoint Mode” to “AUTO”, and make the necessary settings.

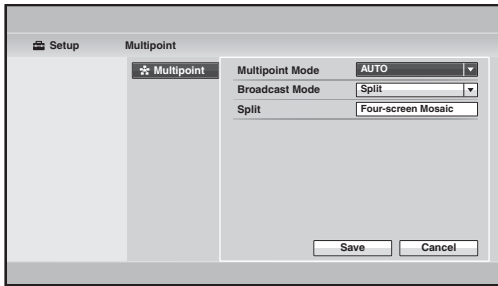

For details on “Broadcast Mode” and “Split”, see “Using the Display Control” on page 183.

- 2 Open the Communication setup menu and make the necessary settings.

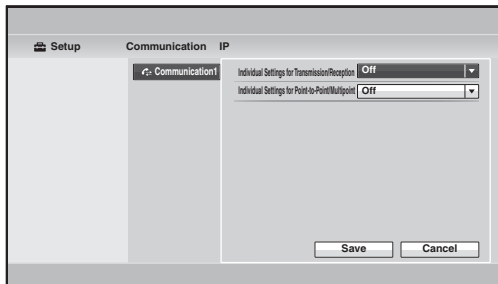

For details, see “Communication Setup Menu” on page 59.

Registering the Remote Parties in the Multipoint Connection List

You can register a multipoint connection list that includes all remote parties for a multipoint connection in the Phone Book. It allows you to dial all the parties simultaneously.

You can enter new remote parties to register in the multipoint connection list or add the parties registered in the Phone Book to the multipoint connection list.

To register a multipoint connection list in the Phone Book

The basic procedure for registration is the same as when registering a remote party for a point-to-point connection. For details on the procedure, see “Registering a New Remote Party” on page 112.

- 1 Select “New Entry” in the Phone Book to display the List Edit menu, then enter the name of the multipoint connection list in the Index text box.

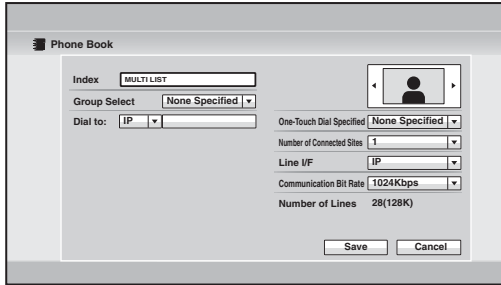

The screenshot shows the 'Phone Book' dialog box. The 'Index' field contains 'MULTI LIST'. The 'Group Select' dropdown is set to 'None Specified'. The 'Dial to:' field has a dropdown menu with 'IP' selected. On the right side, the 'One-Touch Dial Specified' dropdown is 'None Specified', and the 'Number of Connected Sites' dropdown is set to '1'. Other settings include 'Line I/F' (IP), 'Communication Bit Rate' (1024Kbps), and 'Number of Lines' (28(128K)). 'Save' and 'Cancel' buttons are at the bottom.

- 2 Select “Number of Connected Sites” and select the number of sites to which you want to connect.

The “Dial to:” text boxes that correspond to the selected numbers of sites are displayed.

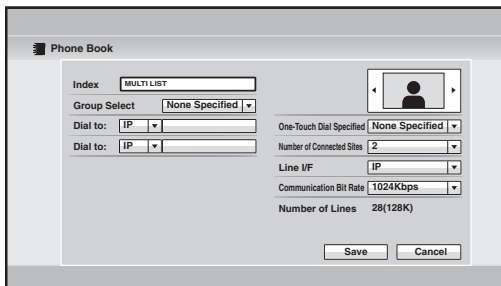

The screenshot shows the 'Phone Book' dialog box. The 'Index' field contains 'MULTI LIST'. The 'Group Select' dropdown is set to 'None Specified'. The 'Dial to:' field has a dropdown menu with 'IP' selected. Below it, a second 'Dial to:' field is now visible, also with 'IP' selected. On the right side, the 'Number of Connected Sites' dropdown is set to '2'. Other settings remain the same: 'One-Touch Dial Specified' (None Specified), 'Line I/F' (IP), 'Communication Bit Rate' (1024Kbps), and 'Number of Lines' (28(128K)). 'Save' and 'Cancel' buttons are at the bottom.

- 3 Select the line interface icon or a still image to be displayed in the Phone Book.

You can select “” as an icon for a multipoint connection list.

- 4 Set up the line interface of the remote parties you want to register in a multipoint connection list in the “Dial to:” text boxes.

Select the line interface from the drop-down list on the left, and enter the number of a remote party in the text box.

For LAN connection: Select “IP” from the drop-down list, and enter the IP address.

For ISDN connection: Select “ISDN” from the drop-down list, and enter the line number.

For ISDN (Telephone) connection: Select “TEL” from the drop-down list, and enter the telephone number. (ex. : 0390123456).

Enter all the parties to which you want to make a multipoint connection.

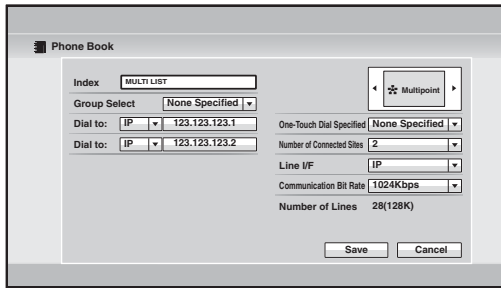

5 Set up other items.

For details on the setup, see step 3 in “Registering a New Remote Party” on page 113.

6 Select “Save”, then press the ENTER button on the Remote Commander. Registration of the multipoint connection list is completed.

To specify a remote party registered in the Phone Book to the multipoint connection list

- 1** Use the **↑**, **↓**, **←** or **→** button on the Remote Commander to select the name you want to register in the multipoint connection list.
- 2** Press the **✳** button on the Remote Commander. Or press the ENTER button on the Remote Commander to display the submenu, press the **↑**, **↓**, **←** or **→** button to select “**✳ On**”, then press the ENTER button.

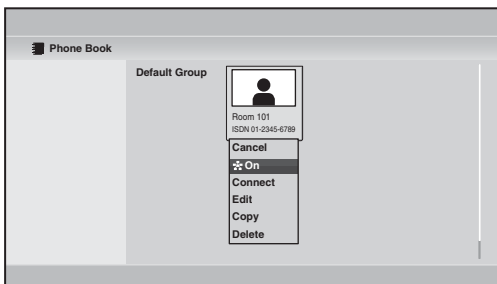





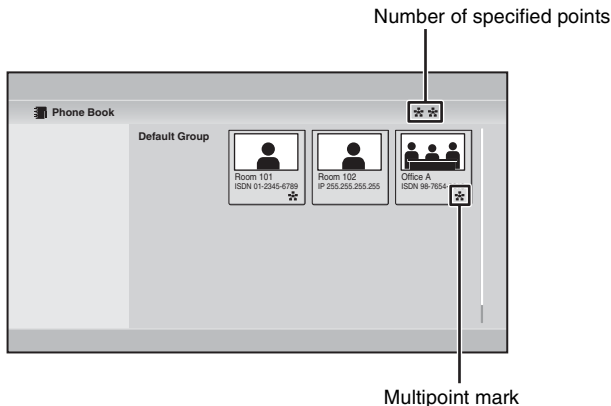







The **✳** (multipoint) mark is added to the lower right of the selected list, and the remote party is registered in the multipoint connection list.

You can add the **✳** marks to up to 2 parties using the same procedure as above. The **✳** marks that correspond to the number of the parties you have registered appear as dark marks on the upper right of the Phone Book.



Note

To delete the  mark from the name list, press the  button on the Remote Commander again, or press the ENTER button on the Remote Commander to display the submenu, press the , ,  or  button to select “ Off”, then press the ENTER button.

- 3 Select one of the remote parties with the  mark, then press the ENTER button.
- 4 Press the , ,  or  button to select “Edit” from the submenu, then press the ENTER button.
The List Edit menu appears. All the IP addresses or telephone numbers of the parties marked with  are entered in the number text boxes.

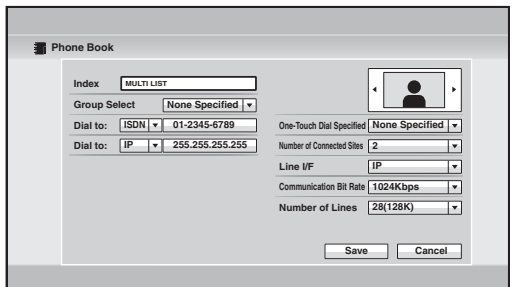





- 5 Enter the name of the multipoint connection list in the Index text box.
- 6 Select “Save”, then press the ENTER button.
The registration of the multipoint connection list is completed.

Starting a Multipoint Connection

Calling Remote Parties





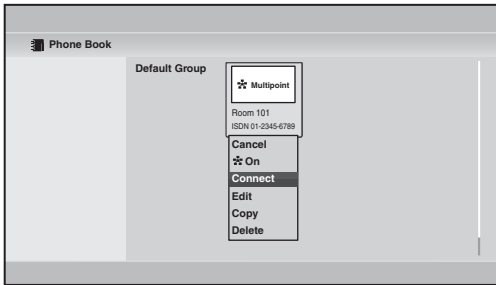

To call remote parties registered in the multipoint connection lists

- 1 Select the multipoint connection list registered in the Phone Book.
- 2 Press the CONNECT () button on the Remote Commander, or press the ENTER button on the Remote Commander to display the submenu, press the , ,  or  button to select “Connect”, then press the ENTER button.





The system begins dialing the remote parties registered in the multipoint connection list. “Dialing” appears on the monitor screen. When the system connects to all the remote points, the message “Session Connected.” appears on the screen, and the pictures of the remote parties are displayed on the screen.

To call remote parties by selecting from the Phone Book

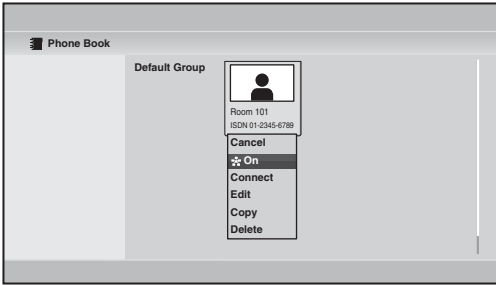
- 1 Select a remote party to which you want to connect for a multipoint connection from the Phone Book.
- 2 Press the  button on the Remote Commander, or press the ENTER button on the Remote Commander to display the submenu, press the , ,  or  button to select “ On”, then press the ENTER button.







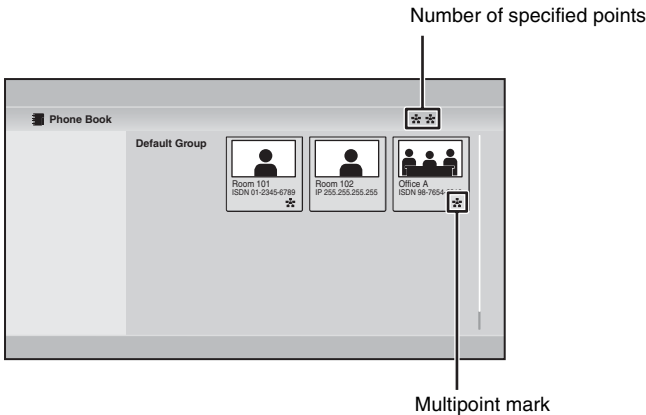









The  (multipoint) mark is added to the lower right of the selected name in the Phone Book list and the remote party is specified to the party for the multipoint connection.

You can add the  marks for up to five parties using the same procedure as above. The  marks that correspond to the number of the parties you have selected appear as dark marks on the upper right of the Phone Book.



Note

To delete the  mark from the name list, press the  button on the Remote Commander again, or press the ENTER button to display the submenu, press the , , , or  button to select “ Off”, then press the ENTER button.

- 3 Select one of the remote parties with the  mark.
- 4 Press the CONNECT () button on the Remote Commander, or press the ENTER button on the Remote Commander to display the submenu, press the , , , or  button to select “Connect”, then press the ENTER button. The system begins dialing the remote parties with the  marks. “Dialing” appears on the monitor screen. When the system connects to all the remote points, the message “Session Connected.” appears on the screen, and the pictures of the remote parties are displayed on the screen.

To call remote parties not registered in the Phone Book

Basic operations are the same as those for a point-to-point connection.

For details, see “Calling a Remote Party Not Registered in the Phone Book” on page 105.

- 1 Select “Detailed Dial” in the Home menu or press the CONNECT () button on the Remote Commander to open the Detailed Dial menu.
- 2 Select “Number of Connected Sites” and select the number of the points to which you want to connect.
The “Dial to:” text boxes that correspond to the selected number of points appear.

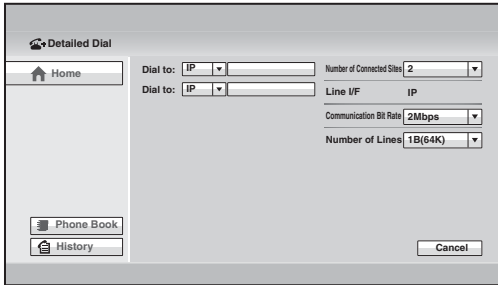

- 3 Set up the line interface of the remote parties in the “Dial to:” text boxes. Select the line interface from the drop-down list on the left, and enter the number of a remote party in the text box.
For LAN connection: Select “IP” from the drop-down list, and enter the IP address.
For ISDN connection: Select “ISDN” from the drop-down list, and enter the line number.
For ISDN (Telephone) connection: Select “TEL” from the drop-down list, and enter the telephone number (ex. : 0390123456).

Enter all the parties with which you want to make a multipoint connection.

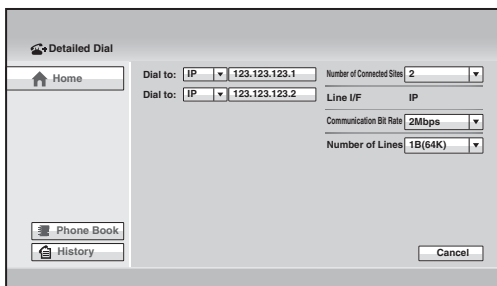

For details on the setup, see “Calling a Remote Party Not Registered in the Phone Book” on page 105.

- 4** Select “Connect”, and press the ENTER button on the Remote Commander, or press the CONNECT () button on the Remote Commander.

The system begins dialing the remote parties selected in step 3. “Dialing” appears on the monitor screen.

When the system connects to all the remote points, the message “Session Connected.” appears on the screen, and the pictures of the remote parties are displayed on the screen.

To call additional remote parties

After starting communication with the first party, press the CONNECT () button on the Remote Commander to display the menu.

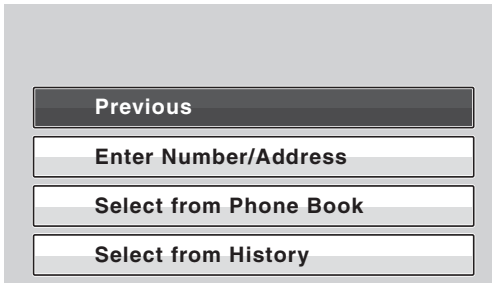

Call the second remote party by using one of the procedures described in “Starting a Connection by Calling a Remote Party” on page 97 depending on the registration status of the party. When you press the CONNECT () button on the Remote Commander after the communication starts with the second remote party, the above menu opens again and you can call the next party.

Notes

- When “Direct Dial” or “One-Touch Dial” is set to “On” in the Home Menu setup menu, selecting “Previous” from the above menu displays the necessary items for direct dialing or the one-touch dial buttons on the monitor screen.
- The Phone Book opens when you press the # button during communication. It is convenient for calling a remote party registered in the Phone Book.

If some points are not connected

The following dialog appears. Only the connected points are shown as dark circles. Select the desired item.

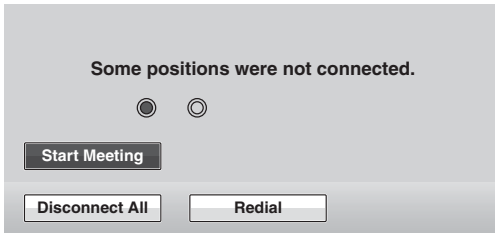

Start Meeting: Starts communication with remote parties connected.

Disconnect All: Cancels all the connections and restores the Home menu.

Redial: Redials the numbers of the points that you failed to connect.

Note on multipoint videoconferences using ISDN

If the number of remote points connected increases as a result of dialing from the main terminal while making a multipoint connection using ISDN, some of the channels that have been used for connection will be cut off and used for the newly connected points instead. For example, if you use six ISDN lines (up to 12B channels available), 12B channels will be used for the first remote point only when no other points are connected. When the system connects to a second point, the number of channels for the first point decreases, and 6B channels will be used for both the first and second points.

Even if one of the remote points in a multipoint connection is disconnected, the number of channels used for the remaining points will not increase.

Receiving a Call from a Remote Party

Operations are the same as those for a point-to-point connection.

For details, see “Receiving a Call from a Remote Party” on page 109.

Using the Display Control

During a multipoint connection you can control the following operations.

Broadcast Mode

There are four broadcast modes, “Split” and “Voice Activate”, and “Split (fixed)” and the broadcast select mode.

You can set up “Split” and “Voice Activate” modes in “Broadcast Mode” of the Multipoint setup menu.

You can select “Split (fixed)” and broadcast select modes in the Layout menu during communication.

Split mode

This mode allows display of the pictures of the connected remote terminals and the picture of the local terminal by splitting the monitor screen.

You can select “Six-screen Mosaic” or “Four-screen Mosaic” in “Split” of the Multipoint setup menu.

The split windows A to B display the pictures of the remote terminals in the connected sequence.

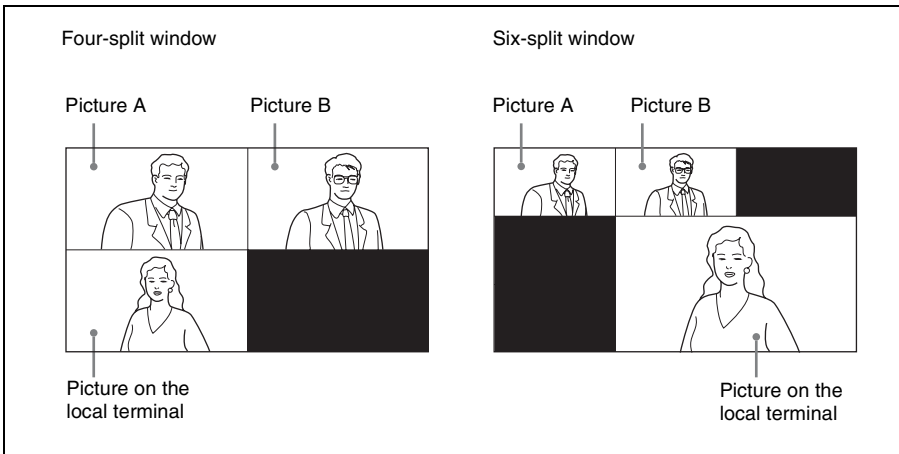

Notes

- When the six-split window is displayed, the system detects the terminal including the loudest voice among all the terminals and displays the picture of that terminal in the lower right window. The picture on the local terminal is then displayed in the window where the picture of the detected terminal was displayed.
- If you switch the broadcast mode from “Split” to “Voice Activate” in which the picture of a specified terminal is displayed in full screen during communication, the location of Pictures A to B will be changed when “Split” mode is restored.

- When there is one terminal, the picture is displayed in full screen regardless of the setting.
- When the six-split window with a terminal specified is displayed, the picture from the specified terminal is always displayed in the lower-right window.
- When “Split” mode is selected, you cannot control the camera on any connected remote terminals.

Voice Activate mode

This mode allows you to detect the terminal with the loudest voice among the connected terminals and to display the picture of that terminal in full screen on all other terminals. The “**V.A.**” indicator appears when “Voice Activate” mode is activated. The indicator with an alphabetic letter (ex. : **A**) indicating the terminal of the displayed picture also appears. The  indicator is displayed on the monitor screen while the local picture is broadcast.

Note

To transmit pictures with resolution of 720p (1280 × 720 pixels) in H.264 Video Mode when “Voice Activate” is activated, select “Voice Activate (720P)” in “Broadcast Mode” of the Multipoint setup menu. However, the “Voice Activate (720P)” mode cannot be selected when the communication is made via an ISDN or SIP connection. Even for an IP connection, this mode is not available if the remote party does not support H.264 Video Mode.

Fixed split mode

The pictures from the connected remote terminals and the picture of the local terminal are displayed in split windows on the monitor screen as the same manner as those in “Split” mode.

You can specify a picture among the split windows to fix it in the lower right window for the six-split mode. Pictures other than the specified one are displayed in the split windows in the connected sequence.

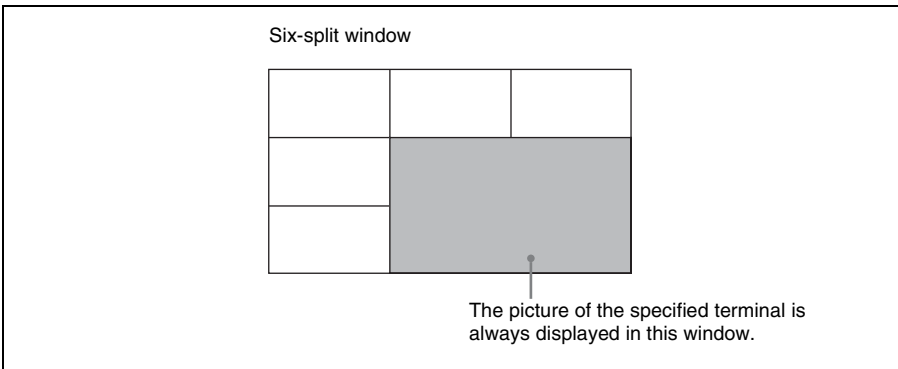





Broadcast select mode

You can specify a terminal to display the picture of that terminal in full screen on all other terminals. The indicator with an alphabetic letter (ex. : **A**) indicating the terminal of the displayed picture also appears. The  indicator is displayed on the monitor screen while the local picture is broadcast.

Broadcast Modes and Displayed Windows

The chart described below shows the window displayed on the monitor screen when you select one of the broadcast modes. According to the connection status of your system, some modes cannot be selected. You cannot select the broadcast mode if your connection status corresponds to that with no display window in the chart below.

Connection status		Non-cascade connection			
		LAN connection (page 171) ISDN connection (page 172) LAN & ISDN connection (page 173)			
Connecting points (max.)		3			
Broadcast mode	Before communication	Four-screen Mosaic			
		Four-split window 			
		Six-screen Mosaic			
		Six-screen mosaic 			
		Split (fixed)	For four-split	—	
			For six-split	Six-split window 	
Voice Activate		Full screen 			
Broadcast Select		Full screen 			

Switching the Broadcast Mode

At the beginning of the connection, the broadcast mode set in “Broadcast Mode” and “Split” of the Multipoint setup menu is applied. You can change the mode during communication using the Layout menu.

Note

If “Broadcast Mode” of the Multipoint setup menu is set to “Voice Activate (720P)”, you cannot switch “Broadcast Mode” during communication as the “Broadcast Mode” does not appear in the Layout menu. Set “Broadcast Mode” before starting communication.

- 1 Press the LAYOUT button on the Remote Commander.
The Layout menu appears.
- 2 Use the **↑**, **↓**, **←** or **→** button on the Remote Commander to select the mode to which you want to switch from “Broadcast Mode”, then press the ENTER button.

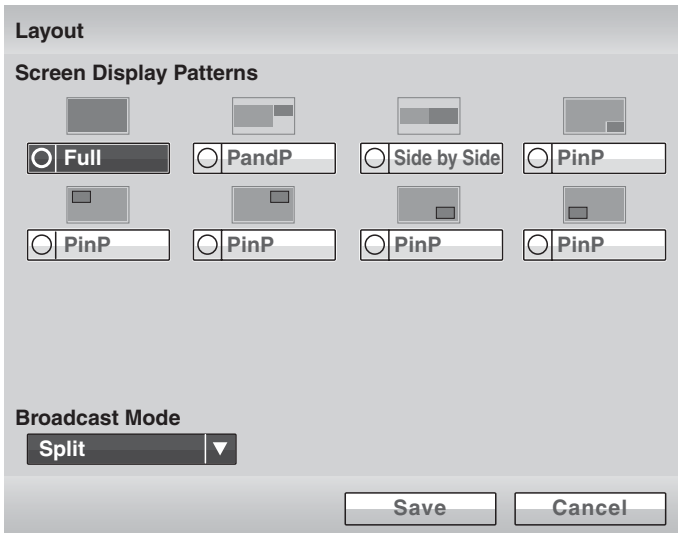

Split: Selects the Split mode.

Split (A fixed): Fixes the picture of the terminal connected first in the specified window of the fixed split mode.

Split (B fixed): Fixes the picture of the terminal connected second in the specified window of the fixed split mode.

Split (Near End Fixed): Fixes the local picture in the specified window of the fixed split mode.

Voice Activate: Selects “Voice Activate” mode.

Self Broadcast: Broadcasts the local picture in broadcast select mode.

A Broadcast: Broadcasts the picture of the terminal connected first in broadcast select mode.

B Broadcast: Broadcasts the picture of the terminal connected second in broadcast select mode.

To display the local picture in “Voice Activate” mode

You can display the local picture only on your monitor screen even if “Voice Activate” mode is activated. All other terminals remain in “Voice Activate” mode.

1 Press the LAYOUT button on the Remote Commander to display the Layout menu.

The instruction “F1: Switches the monitored picture between the remote and local sites.” appears in the lower part of the screen.

2 Press the F1 button on the Remote Commander.

The local picture appears on your monitor screen.

To restore “Voice Activate” mode on the local site

Press the F1 button on the Remote Commander again.

Receiving the Broadcast Requested From Another Terminal

When you receive the “Self Broadcast” command from one of the terminals connected, the picture of that terminal is broadcast in full screen.

When you receive the “Stop Broadcast” command from one of the terminals connected, the system returns to the previous mode.

Note



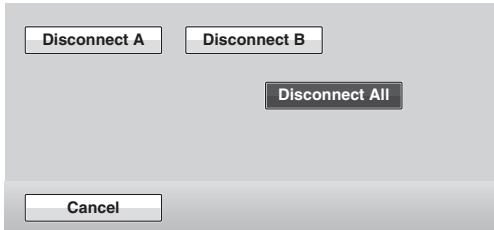

If you have received the “Self Broadcast” command from another terminal, the operation above will not be carried out.

Ending the Multipoint Connection

- 1 Press the CONNECT () button on the Remote Commander. The following menu appears:



The alphabetic letters A to B indicate the connected sequence of terminals. The terminal names are displayed in the menu if you set “Display Terminal Name” to “Show temporarily” or “Always show” on the Menu Screens page in the General setup menu.

- 2 Use the , ,  or  button on the Remote Commander to select the terminal to be disconnected, then press the ENTER button.
Disconnect A: Disconnects the terminal connected first.
Disconnect B: Disconnects the terminal connected second.
Disconnect All: Disconnects all the terminals.

The selected terminal is disconnected.

You can also disconnect all the terminals by pressing the DISCONNECT () button on the Remote Commander.

To cancel the disconnection

Select “Cancel” in step 2, then press the ENTER button on the Remote Commander.

Notes on Secondary Terminals

If there is a terminal that is not adequate for the settings set by this system, that terminal is called a secondary terminal.

Communication capabilities between secondary terminal and this system are shown below.

- Transmitting/receiving audio
- Receiving video from a secondary terminal
- Disables transmission of video to a secondary terminal

For details on secondary terminals, see “Glossary” on page 245.

When a normal phone is connected

The audio mode of the Visual Communication Systems is not affected if a normal phone is connected or disconnected at any time.

When a 56K network is mixed among the terminals if the connection is made via a 64K network

The connection automatically changes to that via the 56 K network. Terminals that cannot change to that network are regarded as secondary terminals, and the transmission of video is not available, although transmission/reception of audio and reception of video are available.

When a terminal with different audio mode is connected and its video bit rate is different

The connection is made in the audio mode of the terminal with the lowest video bit rate. Any terminal that cannot conform to the audio mode is regarded as a secondary terminal, and the transmission of video is not available, although transmission/reception of audio and reception of video are available.

Multipoint Attributes

Number	Attribute	Value (H.320 MCU)	Value (H.323 MCU)
1	Maximum number of terminals that can be connected to a single MCU	2 (3 when including the local terminal)	2 (3 when including the local terminal)
2	Maximum number of concurrent (independent) connections that can be supported in a single MCU	1	1
3	Maximum number of ports that can be connected to other MCUs	0	0
4.1	Network interfaces at each port	BRI	LAN
4.2	Restricted network capability	Restrict_Required	–
5	Transmission rates available at each port	1B, 2B, 4B, 6B (BRI)	Restricted on maximum value of total bit rate of all points
6	Audio Processor	Equipped	Equipped
6.1	Mixed/switched Noise/echo suppression on “silent” ports	Mixed No	Mixed No
6.2	Audio algorithm at each port	G.711, G.728, G.722, MPEG4 AAC (monaural only)	G.711, G.728, G.722, MPEG4 AAC (monaural only)
7	Video Processor (motion pictures)	Equipped	Equipped
7.1	Switched/mixed	Voice activated/four-split/six-split/user control	Voice activated/four-split/six-split/user control
7.2	Video algorithm at each port	H.261, H.263, H.264	H.261, H.263, H.264
8	Data Processor	Equipped	Equipped
8.1	Data broadcast facility, LSD Data broadcast facility, HSD	Equipped No	– –
8.2	MLP Processor	Equipped	–
9	Encryption	Support	Support

Number	Attribute	Value (H.320 MCU)	Value (H.323 MCU)
10	Method of choosing Selected Communication Mode - SCM	Custom: Number of lines (1B/2B/4B/6B) Audio algorithm (G.711, G.728, G.722, MPEG4 AAC) Auto: Video frame rate (7.5/10/15/30fps) Video encoding mode (CIF/QCIF) Fixed or switched automatically: Video algorithm (H.261 fixed, H.261, H.263 or H.264 switched automatically) Restrict (56K fixed/ Auto)	Custom: LAN bandwidth (Restricted on maximum value of total bit rate of all points) Audio algorithm (G.711, G.728, G.722, MPEG4 AAC) Auto: Video frame rate (7.5/10/15/30fps) Video encoding mode (CIF/QCIF) Fixed or switched automatically: Video algorithm (H.261 fixed, H.261, H.263 or H.264 switched automatically)
11	Capability of secondary terminals	Capable of audio transmitting/receiving and video receiving only. Capable of audio transmitting/receiving only via a normal phone.	Capable of audio transmitting/receiving and video receiving only. Capable of audio transmitting/receiving only via a normal phone.
12	Call setup provision(s)	No call/receive reservation	No call/receive reservation
13	Control capabilities	–	–
13.1	Numbering of terminals Simple chair control using BAS	No No	Equipped No
13.2	MLP facilities (T.120)	No	No
13.3	H.224 (simplex data)	Equipped	Equipped
14	Cascading	No	No
14.1	Fixed rates (“simple”)	No	No
14.2	Master/Slave	No	No
15	Terminal identification	No	Equipped
16	MBE capability	No	–

Chapter 7: Computer Display Function

When you are not conducting a videoconference, you can use the monitor of the Communication System as a computer display.

This chapter describes use of the Communication System other than as a videoconference terminal.

Computer Display Function

By connecting the Communication System to a computer, you can view the picture from the computer on the monitor of the system.

Connecting the Computer

To display the picture from the computer on the monitor of the Communication System, connect the RGB IN connector on the system to the computer using a D-sub 15-pin cable (not supplied). You can also connect the AUDIO IN connector on the system to the audio output connector on the computer using an audio connection cord (not supplied), and output the computer's audio from the system's speakers.

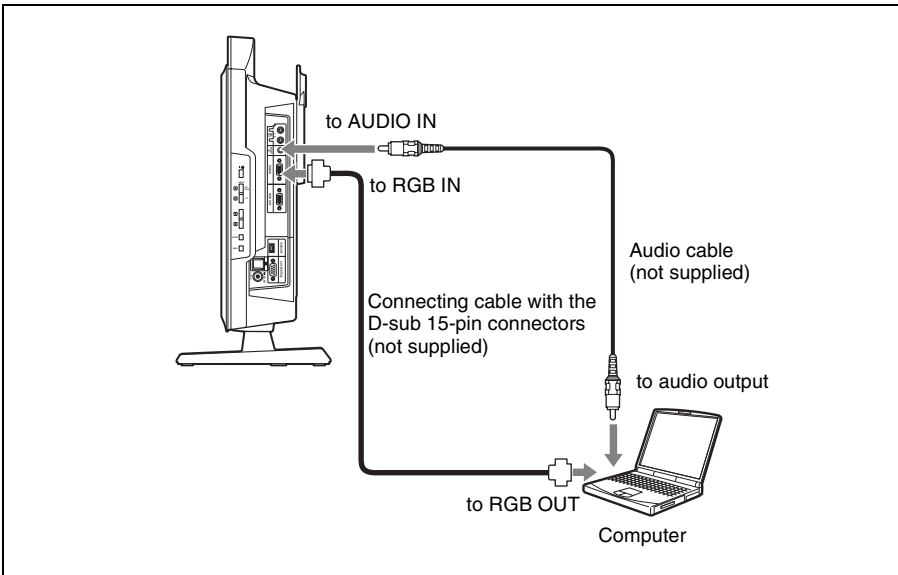

Displaying the Computer Picture

- 1 Press the PC/RGB button on the right side of the system. The monitor switches to the computer picture display, and the PC/RGB indicator on the front of the system lights green.

Outputting the Computer Audio

- 1 Set “Audio Input” to “AUX” or “MIC+AUX” in the Audio setup menu.

Notes

- When “AUX” is selected during a conference, audio from the computer is output to the remote party. If “AUX” is selected and you want to use microphone audio during a conference, change the setting to “MIC”.
- When “MIC+AUX” is selected during a conference, both the microphone audio and the audio from the computer are output to the remote party.

- 2 Set “AUX Local Monitor Out” to “On” in the Audio setup menu.
- 3 Press the VOLUME +/- buttons on the Remote Commander to adjust the volume of the computer audio.

Switching between Videoconference and Computer Pictures

You can press the PC/RGB button or VC button on the right side of the system to switch between the computer and videoconference pictures.

Two-Picture Display

You can view both the videoconference picture and the computer picture on the monitor at the same time with one of the pictures displayed as the main picture.

If you press the VC button while the videoconference picture is displayed, the monitor switches to a two-picture display with the videoconference picture as the main picture. If you press the PC/RGB button while the computer picture is displayed, the monitor switches to a two-picture display with the computer picture as the main picture.

You can also switch between two-picture displays as follows by pressing and holding the LAYOUT button on the Remote Commander.

Videoconference picture → two-picture (videoconference main) → two-picture (computer main) → computer picture

Note

If the system does not support the video signals output from the computer, two-picture display may not be possible.

For details on supported video signals, see “Acceptable signals during computer display” on page 232.

Automatic Switching from the Computer Picture

If the following occur while the computer picture is displayed on the monitor in full screen or as the main picture in a two-picture display, the display will automatically switch to a two-picture display with the videoconference picture as the main picture.

- Remote Commander operations excluding MIC ON/OFF and VOLUME +/- are performed.
- The power switch on the Communication System is pressed.
- The system enters standby mode.
- An error message appears in the videoconference.

Starting a Videoconference during Computer Display

Calling a Remote Party during Computer Display

You cannot call a remote party when only the computer picture is displayed on the monitor of the system. Press the VC button on the side of the system to switch to videoconference display before calling the remote party.

Receiving a Call during Computer or Two-Picture Display

When a call is received from a remote party, the display will automatically switch to a two-picture display with the videoconference picture as the main picture. Operations for answering the call differ depending on whether auto answer mode or manual answer mode is configured.

For details on operations after receiving a call, see “Receiving a Call from a Remote Party” on page 109.

Adjusting the Picture Quality of the Display

You can adjust the picture quality using the buttons on the right side of the system.

- 1 Press the MENU button on the system to display the menu screen.

Note

The menu also appears during two-picture display and videoconference display.

- 2 Use the **▲** and **▼** buttons on the system to select a settings menu, and press the ENTER button or **▶** button.
The selected menu appears.
- 3 Use the **▲** and **▼** buttons on the system to select a setting, and press the ENTER button.
- 4 Configure the selected setting, and press the ENTER button.
The configuration of the selected setting is applied.

To finish picture quality adjustment, press the MENU button.

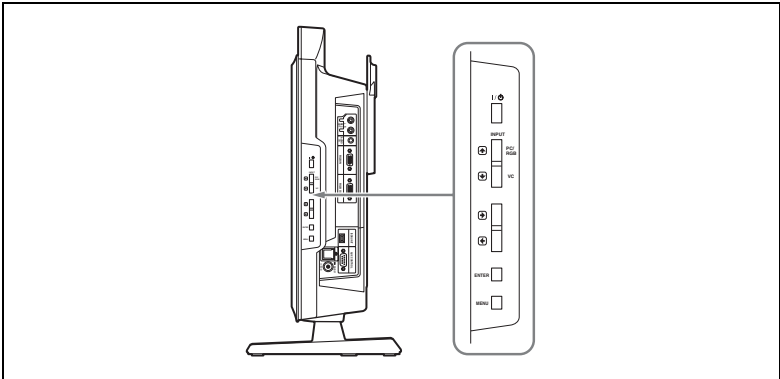

Picture menu

Picture mode

Select the picture quality.

Dynamic: Display a dynamic picture with emphasis on definition and contrast.

Standard: Display a standard picture with emphasis on naturalness.

Reset

Reset the “Picture mode” setting to the factory default setting.

Backlight

Configure the brightness of the backlight.

Moving left on the adjustment bar decreases the brightness of the screen, and moving right increases it.

Contrast

Configure the contrast level.

Moving left on the adjustment bar decreases the contrast, and moving right increases it.

Brightness

Configure the brightness.

Moving left on the adjustment bar decreases brightness, and moving right increases it.

Color Temp.

Adjust the white balance.

High: Select bluish color tones.

Medium: Select median color tones.

Low: Select reddish color tones.

Screen menu

Configure display settings that will be used during computer picture display.

Note

Screen menu settings only apply to full-screen computer picture display. The menu does not appear during videoconference or two-picture display.

Wide Mode

Select the display mode.

Full1: Fill the vertical length of the screen with the full vertical length of the picture while maintaining the aspect ratio. Black bars may appear on the margins of the screen.

Full2: Fill the entire screen with the picture.

Zoom: Fill the entire screen with the picture while maintaining the aspect ratio. The top and bottom of the picture will be cut off.

Note

If the aspect ratio of the input signal from the computer is 16:9 or wider, this setting is fixed at “Full1”.

V Center

Adjust the vertical position of the picture.

Note

This setting may be disabled depending on the input signal.

**Adjust Signal
APA**

Automatically adjust phase, pitch, and shift to optimal values for the picture signal input from the computer (auto pixel alignment).

Phase

Adjust pixel and computer signal positions. Set the value that produces the clearest picture.

Pitch

Adjust the horizontal size of the picture. Set a value that matches the pixel count of the input signal.

Shift

Adjust the picture position.

H: Adjust the horizontal position. Increasing the value moves the picture to the right, while decreasing the value moves it to the left.

V: Adjust the vertical position. Increasing the value moves the picture upward, while decreasing the value moves it downward.

Setup menu**Power Saving**

On: When no RGB input signal is detected and there are no key operations for 10 minutes, the system automatically enters power saving mode.

Off: The system does not enter power saving mode, even if an RGB input signal is not detected and key operations are not performed for prolonged periods.

Note

This function is disabled during videoconference picture display and two-picture display.

Notes

- Information on the main picture is displayed during two-picture display.
- fH (horizontal frequency) and fV (vertical frequency) information may not appear properly depending on the input signal.

For details on supported video signals, see “Acceptable signals during computer display” on page 232.

fH (horizontal frequency)

Displays the horizontal frequency.

fV (vertical frequency)

Displays the vertical frequency.

Signal type

Displays the resolution of the input signal.

Chapter 8: Web Control Function

This chapter describes the Web Control Functions used when operating the PCS-XL55. The Web Control Function helps you control the PCS-XL55, or change its setup configuration, using a Web browser installed on your PC, such as Internet Explorer.

Internet Explorer is a product of the Microsoft Corporation. Please use Version 5.0, or above (Version 6.0 recommended).

Opening the Web Page

Enter the IP address assigned to the PCS-XL55 in the address line of your browser.

Example: For IPv4 addresses

`http://xxx.xxx.xxx.xxx/`

(“xxx.xxx.xxx.xxx” represents the IPv4 address.)

Example: For IPv6 addresses

`http://[xxxx:xxxx:xxxx:xxxx:xxxx:xxxx:xxxx:xxxx]/`

(“xxxx:xxxx:xxxx:xxxx:xxxx:xxxx:xxxx:xxxx” represents the IPv6 address.)

Note

When a proxy server in an external network segment has been set, the Gateway address in the PSC-XL55 LAN setup must also be set. Or set your Web browser proxy setting to “No Proxy” for the PCS-XL55.

Identifying a User

Once you reach the Web page, the following window will be displayed asking you to identify yourself as the user.



Enter one of the following user names (see below) into the “User Name” box and the corresponding password into the “Password” box, then click the [OK] button.

Each character of a password is shown as “*” on the screen.

When the user name and password are correct, the “Home” menu will come up.

If an incorrect user name or password is entered, you are asked to enter it again. When the incorrect entries are made three times, an error message appears on the screen.

You can select a user name from the following and enter the password for the selected user name.

[remote]

Enter the Remote Access Password set in the Administrator setup menu. You can access and check the “Phonebook” and “Setup” pages.

[address]

Enter the Phone Book Modification Password set in the Administrator setup menu. You can access the “Phonebook” page, change the setting of the page, and register a new entry onto the page. And you can check the “Setup” pages.

[sonypcs]

Enter the Administrator Password set in the Administrator setup menu. You can access the “Phonebook” page, change the setting of the page, and register a new entry onto the page. And you can check and modify the “Setup” pages.

[streaming]

Enter the Streaming Broadcast Password of the terminal transmitting via streaming broadcast. You can receive and view the contents of the transmitted communication.

[setting]

Enter the Save Settings Password set in the Administrator setup menu. You can check and modify the settings in the “Phonebook” page or register new entries. You can also check the settings in the “Setup” page and modify settings other than administrator settings.

Notes

- If passwords have not been registered, leave the “Password” box blank and click the [OK] button.
- The Administrator Password, Phone Book Modification Password, Save Settings Password, Remote Access Password, and Streaming Broadcast Password are registered in the Password page of the Administrator setup menu.
- When you enter a password to access the Web page, the password authorization will be valid until you quit the Web browser. If you simply close the Web browser without quitting, the access authorization will still be valid when you open the Web browser again.
- Depending on the operating environment, unauthorized third parties on the network may be able to access the system. We strongly recommend configuring all of the passwords for security purposes. Configure all the passwords on the Password page (page 77) of the Administrator setup menu.

Selecting a Menu

By clicking a menu name on the left part of the page, you can display the corresponding menu page.

Menu items

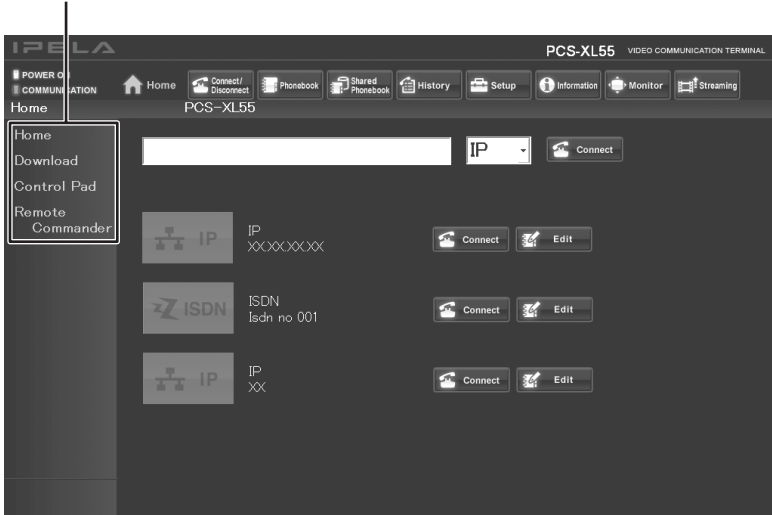

[Home]

Displays the “Home” menu to select the line I/F to connect to a remote party, enter the address of the remote party and dial. The information icons for this system are also displayed.

[Download]

Displays the “Download” menu to download logs.

[Control Pad]

Displays the control panel to control the system.

[Remote Controller]

Displays the image of the Remote Commander (PCS-RF1) supplied with the system. It allows you to perform the same operations as those on the Remote Commander.

How to Use [Home] Menu

When you click [Home] on the left part of the page, the Home menu appears. You can also display the Home menu by entering the correct password on the name entry screen.



To dial by entering a number

- ① Select the line interface (IP, ISDN or SIP).
- ② Enter the telephone number or address of a remote party into the text box.
- ③ Click the [Connect] button.

How to Use [Download] Menu

When you click [Download] on the left part of the page, the Download menu appears.

Various log files can be shown.

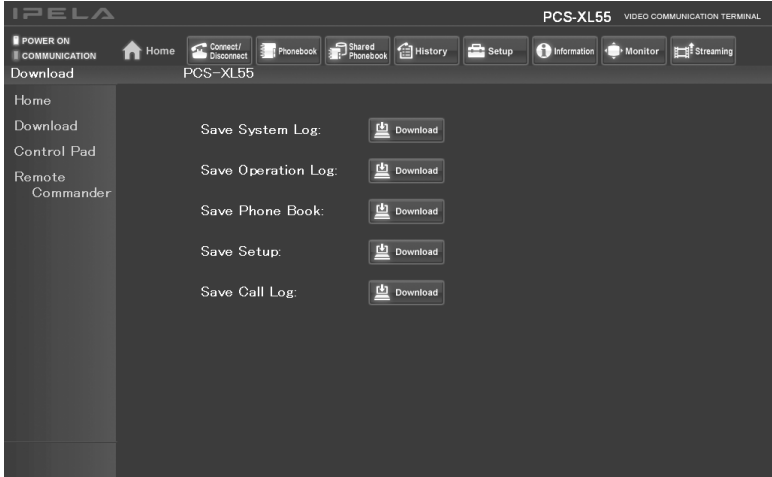

Select the log file you want to display, and click the [Download] button. You can check the log files in a separate window.

How to Use [Remote Commander] Menu

When you click [Remote Commander] on the left part of the screen, the Remote Commander image appears.



By clicking the various buttons on the Remote Commander image, you can control the system in the same way you can when using a real Remote Commander (PCS-RF1), operating the camera, and dialing phone numbers.

Selecting a Tool

By clicking the tools button on the top part of the page, you can jump to the corresponding tools page.



[Connect/Disconnect]

Calls a remote party using direct dialing and ends a communication.

[Phonebook]

Displays the dial list of the Phonebook.

Connects from the Phonebook.

Registers, confirms, or edits the dial list.

For a private phone book, the “Phonebook” button changes to the “Private Phonebook” button.

[Shared Phonebook]

You can use the Shared Phone Book.

[History]

Displays the Dial, Answer and Missed Call history lists.

Dials from the history.

Deletes an unnecessary history record.

[Setup]

Confirms or modifies the setup.

[Information]

Confirms the machine information, peripheral status and communication mode.

You can also check the network routing, and can display the recorded files in a “Memory Stick”.

[Monitor]

You can monitor the picture on the Communication System.

Note

When “Web Monitor” is set to “Off” on the Access Permit page of the Administrator setup menu, you cannot use the [Monitor] page.

[Streaming]

You can watch the live stream of a communication.

Notes

- QuickTime version 6.0 or above is needed to view a communication.
- When “Streaming” is “Disabled” on the Streaming/Recording page of the Administrator setup menu, the communication cannot be watched. If “Video” is set to “Off” on the Streaming/Recording page, only the audio stream of the communication is broadcast, and video cannot be watched.

How To Configure KIOSK Mode

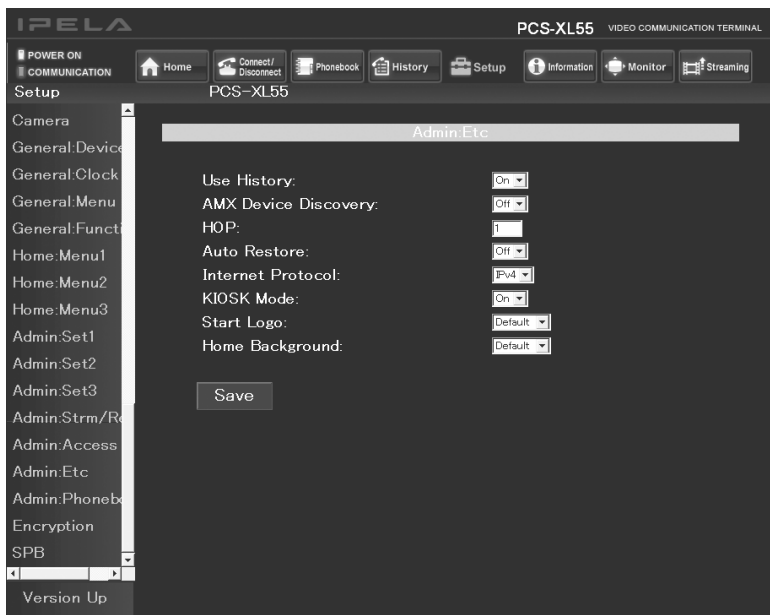

You can select the background of the Home menu and the logo that is displayed while the system is running.

Notes

- The KIOSK Mode setting can only be configured using the Web Control Function.
- For detailed information on the KIOSK Mode setting, consult your Sony dealer.

- ① Click [Setup] at the top of the screen.
- ② Click [Admin:Etc] that appears on the left side of the screen.
The “Admin:Etc” screen appears.
(You can only configure this setting when “sonypcs” has been entered as the user name.)
- ③ Set “KIOSK Mode” to “On”.
- ④ Click the [Save] button.
After saving is complete, the page display is refreshed.

How to Use [Version Up] Page

When you click [Setup] on the top part of the page, [Version Up] appears on the lower left of the page.

Clicking [Version Up] displays the [Version Up] page.

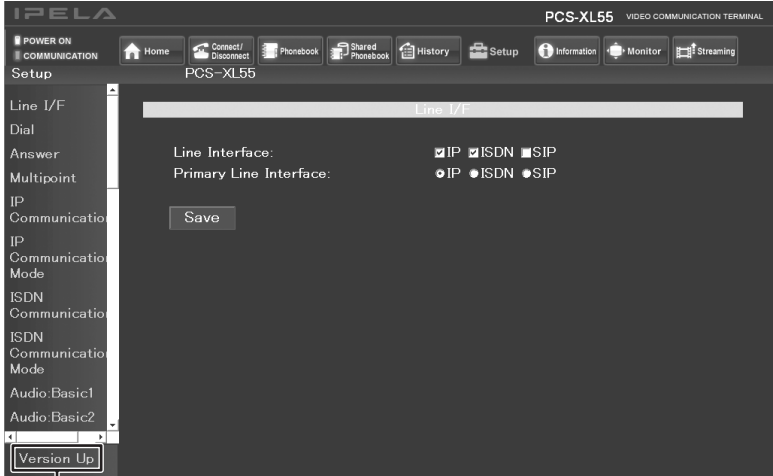

Version Up

Click [Reference] and select the software you want to upgrade, then click the [Upload] button.

When upload is complete, a message appears and the version upgrade begins. After the upgrade is complete, the system reboots. Do not turn off the power until rebooting is complete.

You can also upload Phone Books and configuration files by selecting them with [Reference].

How to Use [Streaming] Page

- ① On the user name entry screen, enter “streaming” in the [User Name] box and the Streaming Password of the terminal transmitting via streaming broadcast in the [Password] box.
- ② Click the [Streaming] button to start QuickTime and start watching a communication.

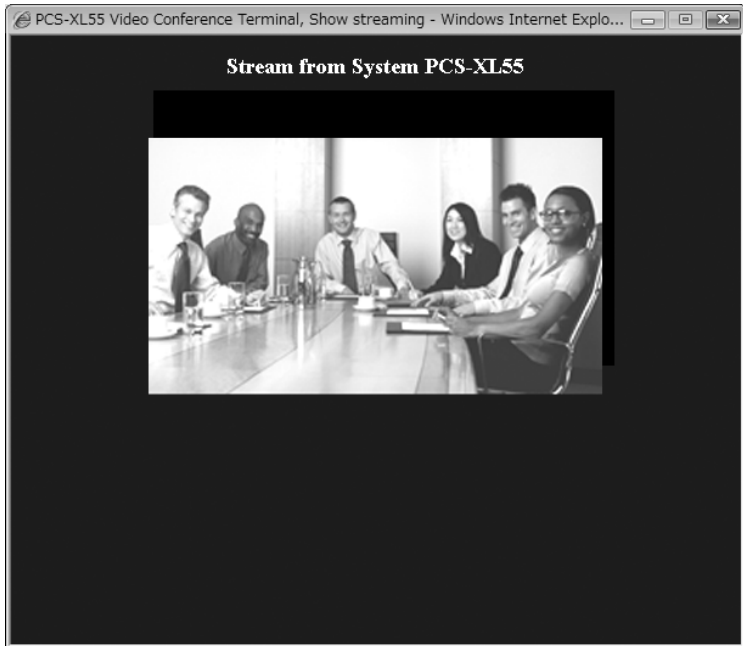

Notes

- QuickTime version 6.0 or above is required to view a communication. If QuickTime is not installed on your computer, download it for free from the following Web site: <http://www.apple.com/quicktime/download/>
- When “Streaming” is “Disabled” on the Streaming/Recording page of the Administrator setup menu, the communication cannot be watched. If “Video” is set to “Off” on the Streaming/Recording page, only the audio stream of the communication is broadcast, and video cannot be watched.
- Depending on Web access limitations, about 10 terminals can view a streaming broadcast simultaneously. The actual number of terminals that can view the broadcast simultaneously depends on your system’s operating environment.

How to Use [Monitor] Page



When you click [Monitor] of the tools buttons, the [Monitor] page opens. You can monitor the picture on the Communication System.

Note

When “Web Monitor” is set to “Off” on the Access Permit page of the Administrator setup menu, or while the encrypted connection is made, you cannot use the [Monitor] page.

Appendix

Location and Function of Parts and Controls

PCS-XL55 HD Visual Communication System

Front

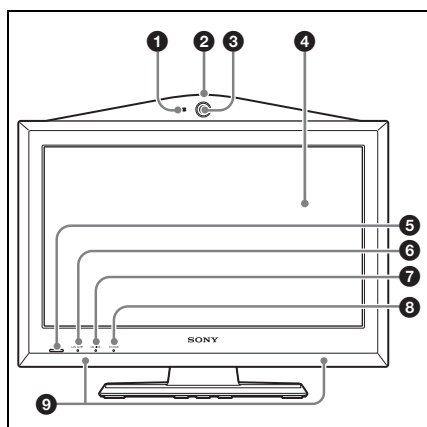

- 1 Microphone**
- 2 Lever for lens cover**
Opens and closes the camera lens cover.
- 3 Camera lens**
- 4 Monitor**
- 5 I/O (power) indicator**
Starts blinking in green when the power switch is pressed to on, then lights in green. Lights in orange when the system is set to standby mode.

6 LAN ALERT indicator
When the system is connected to LAN via the  connector on the rear, this indicator lights in yellow when packet error (loss) or link error occurs during communication.

7 ON LINE indicator
Blinks in blue while dialing or receiving a call, and stays lit in blue during communication.

8 PC/RGB indicator
Indicates the display mode of the monitor.
Lights green when the monitor is being used as a computer display. The indicator flashes in yellow if there is a malfunction with the monitor.

9 Speakers

Left side

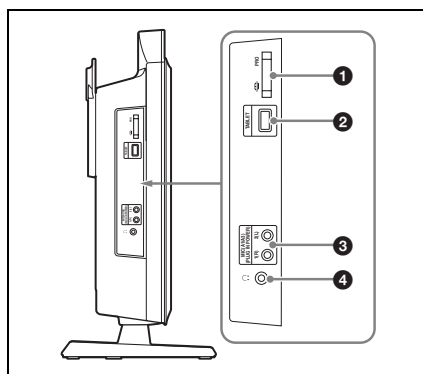

1 Memory Stick slot
Insert a “Memory Stick” (not supplied) into this slot.
A “Memory Stick Duo” can also be inserted.

2 TABLET connector
Connect to a pen tablet (not supplied) for annotation, or the Key Module (not supplied) for software installation.

- 3 MIC (A1/A3) 1 (R)/2 (L) jacks (minijack)**
Connect to PCS-A1 microphones (not supplied) or PCSA-A3 microphones (not supplied), or to commercially available headsets. Power is supplied to the microphones from the System.

- 4 \odot (headphone) jack (stereo mini jack)**
Connects to commercially available headphones or headsets.

Right side

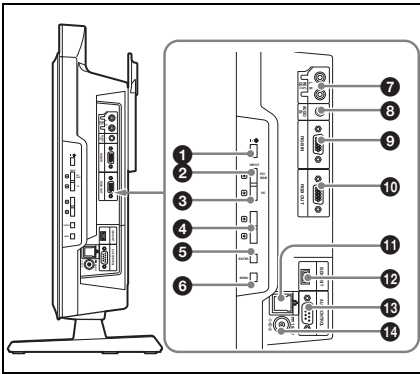

- 1 I/O (power) switch**
Turns on/off the system.
- 2 PC/RGB button**
Switches the monitor from videoconference display to computer picture display.
When navigating the monitor adjustment menu, this button can be used to move the cursor.
- 3 VC button**
Switches the monitor from computer picture display to videoconference display.
When navigating the monitor adjustment menu, this button can be used to move the cursor.

- 4 \leftarrow/\rightarrow buttons**
Moves the cursor when navigating the monitor adjustment menu.
- 5 ENTER button**
Confirms selections when navigating the monitor adjustment menu.
- 6 MENU button**
Displays the monitor adjustment menu.
- 7 REC OUT L/R connectors (phono jack)**
Used when recording the audio signals to minute a communication. The mixed sounds of the local and remote parties are output from these connectors.
- 8 AUDIO IN L/R jacks (phono jack)**
Connect to the audio outputs of the optional VCR or audio equipment.
- 9 RGB IN connector (D-sub 15-pin)**
Connect to the RGB output of the optional computer or video equipment.
- 10 RGB OUT connector (D-sub 15-pin)**
Connect to the RGB input of the optional projector or display unit.
- 11 \square (LAN) connector (100BASE-TX/10BASE-T, 8-pin modular)**
Used to connect via a LAN or a SIP.
Connect to a hub or a SIP server using the category 5 cable.
- 12 ISDN UNIT connector**
Connect to the TERMINAL connector on the optional PCSA-B384S or PCSA-B768S ISDN Unit.
- 13 AUX CONTROL connector (D-sub 9-pin)**
Used for maintenance service.
- 14 DC 19.5V jack**
Connect the supplied AC Power Adaptor.



PCS-RF1 RF Remote Commander (Supplied)

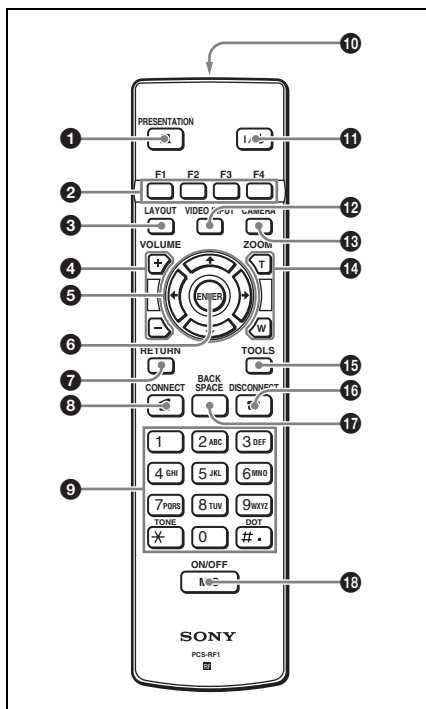

You can set the volume of beep that sounds by pressing a button on the Remote Commander using the menu. You can also set for the beep not to sound.

For the setting, see “Beep Sound” in the Audio setup menu on page 64.

- 1 PRESENTATION button**
Starts or stops transmission of presentation data.
- 2 F1 to F4 (function) buttons**
The function buttons are used for various operations according to the situation.
The current function of the buttons is guided at the bottom of the menu screen.

- 3 LAYOUT button**
Displays the Layout menu to select the screen display pattern.
- 4 VOLUME +/- buttons**
Adjust the volume of the sound received from a remote party.
+: to increase the volume
-: to decrease the volume
- 5 Arrow buttons (↑/↓/←/→)**
Used to select the menu or make various settings in the menu.
- 6 ENTER button**
Executes the selection or setting in the menu and goes to the next step.
- 7 RETURN button**
Used to return to the previous step.
- 8 CONNECT () button**
Used to connect a remote party for communication.
- 9 Number (0-9, #, *) buttons**
Used to enter the letters or numbers of a telephone number, etc.
- 10 Battery compartment (rear)**
Insert two size AA (R6) batteries.
- 11 I/O (power on/off) button**
Sets the System to standby mode when it is turned on. Turns on the System when it is in standby.
- 12 VIDEO INPUT button**
Displays the Video Input menu to switch the video input signal to be displayed on the monitor TV.
- 13 CAMERA button**
Displays the Camera menu to adjust the camera zoom, brightness, etc.

14 ZOOM (T/W) buttons

Zooms in or out.

T: to enlarge the picture

W: to reduce the picture

15 TOOLS button

Displays the Tools menu.

16 DISCONNECT () button

Used to disconnect a remote party in communication.

17 BACK SPACE button

Deletes the letter entered last.

18 MIC ON/OFF button

Turns off the local sound to be sent to a remote party. To restore the sound, press the button again.

PCSA-B384S ISDN Unit (Optional)

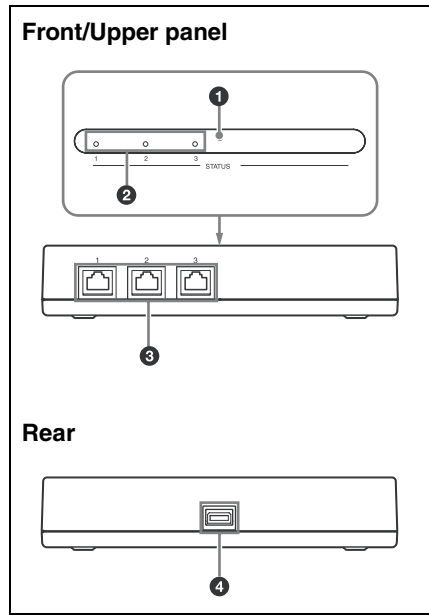

1 POWER indicator

Lights in orange when power is supplied to the ISDN Unit. When initializing is complete, blinks in green.

2 STATUS 1-3 indicators

Lights in orange when link synchronization of each ISDN connector is established. Lights in yellow when each ISDN line is connected.

3 ISDN 1-3 terminals (8-pin modular jack)

Connect to the ISDN lines using the ISDN modular cable.

4 TERMINAL connector

Connect to the ISDN UNIT connector on the System with the interface cable supplied with the ISDN Unit.

PCSA-B768S ISDN Unit (Optional)

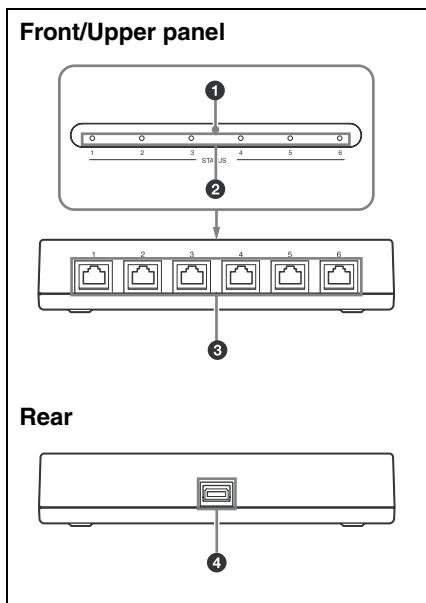

❶ POWER indicator

Lights in orange when power is supplied to the ISDN Unit. When initializing is complete, blinks in green.

❷ STATUS 1-6 indicators

Lights in orange when link synchronization of each ISDN connector is established. Lights in yellow when each ISDN line is connected.

❸ ISDN 1-6 terminals (8-pin modular jack)













Connect to the ISDN lines using the ISDN modular cable.













❹ TERMINAL connector







Connect to the ISDN UNIT connector on the System with the interface cable supplied with the ISDN Unit

Indicators

The following icons appear on the monitor depending on the functions being used.

Indicator	Name	Description
	Near camera control	Local camera being controlled
	Far camera control	Remote camera being controlled
	Mic off (Near)	Local microphone is turned off in communication or not in communication.
	Mic off (Far)	Remote microphone is turned off in communication or not in communication.
	Volume	Volume of remote party's voice being adjusted
	Audio level (stereo)	Audio input level of stereo sound
	Audio level (monaural)	Audio input level of monaural sound
	Character input mode	Character input available
	LAN status (LAN)	LAN connected via the 랜 connector using Internet Protocol version 4 (IPv4).
	LAN status (LAN, IPv6)	LAN connected via the 랜 connector using Internet Protocol version 6 (IPv6).
	ISDN status	Used ISDN ports
	Audio input	Selected audio input (example of the input from the MIC(A1/A3) connector)
	Video input	Selected video input (example of the video from the RGB IN connector)

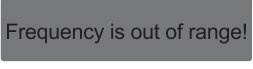
Indicator	Name	Description
	ISDN (telephone) mode	Audio only communication in progress
	“Memory Stick”	“Memory Stick” is inserted into the System.
	Preset load	Recalling the preset camera settings (1-6)
	Presentation (transmitting)	Presentation Executing (transmitting the presentation data to a remote party)
	Presentation (receiving)	Receiving the presentation data from a remote party
	Streaming	Stream broadcast in progress
	Recording	Recording in progress
	Tablet	Pen tablet connected
	Drawing (near)	Drawing rights belong to the local party.
	Drawing (far)	Drawing rights belong to the remote party.
	Pointer (near)	Local party’s pointer
	Pointer (far)	Remote party’s pointer
	Encryption	Connected with encryption

Indicator	Name	Description
	Packet loss	Packet loss occurring
	Voice Activate mode	“Voice Activate” is selected in “Broadcast Mode” in a multipoint connection.
	Broadcast (Near)	Local picture is broadcast in a multipoint connection.
	Broadcast (A-B)	Terminal A (-B) connected first (-second) is broadcast in a multipoint connection.
	No signal	No computer input signal
	Unsupported signal input	Computer input signal not supported by system
	Startup	System starting up

On-Screen Messages

Check the following if a message appears on the monitor when operating the Communication System.

Message	
Cannot complete connection. (The following code and message appear.)	
0	Unknown network error: Try again later.
1	Number does not exist: Check the number and try again.
2	Network congestion: Try again later.
3	Try again later.
16	Normal disconnection: (The line has been disconnected normally.)
17	Line is busy: Try again later.
18,19	System not responding: Check if the remote system is connected.
20	No such subscriber: Confirm the site number.
21	Call rejected: Check if the remote system is connected.
22	Called party number changed: Check the number and try again.
26	Connection restoration request: Try again later.
27	Remote system out of order: Check if the remote system is operational.
28	Invalid number entered: Check the number and try again.
31, 41 – 43, 47	Network not available: Try again later.
33, 34	Line is busy. Try to dial again later.
44	Network not available: Line is busy. Try again later.
50	Not a Subscriber: Check the remote party's facility contract.
57,58	Bearer capability not authorized: Check if "Restrict" is set correctly.
70	Restricted capability: Set "Restrict" to "56K" and try again.
88	Terminal attribute error: Check the connection of the remote system.
91, 95 – 102, 111	Protocol error: Turn off and restart the system and try again.
128	H.221 negotiation timeout: Restart the system and connect again.
131	Board mismatch: Check the optional line interface boards.
132	Invalid SPID: Reregister the SPID.
134	Physical link synchronization error: Check the connection of the ISDN cable.
144, 145	The remote terminal may not be compatible with the BONDING function.
177	LAN connection timeout: Try again later.

Message	
178	LAN connection rejected: Try again later.
179	DNS error.
180	Dialing your own number is invalid.
181	GateKeeper error.
192	PPPoE server admission has failed. Check the PPPoE User Name and Password are entered correctly.
195	Now obtaining an IP address via DHCP.
196	Configure the DNS address or use the IP address to dial.
205	Check the user name or user number for dialing is correct.
207	The remote terminal may not be registered in gatekeeper. Contact the gatekeeper administrator.
209 – 212	Gatekeeper does not respond. Contact the gatekeeper administrator, or use the IP address to dial.
201, 217	Call not responded.
218	Local number is not set correctly in the ISDN Setup menu. Set it correctly. Line connected with 1B (64K).
219	Local number setting for ISDN configuration may not be correct in the remote party. Line connected with 1B (64K).
230, 231	PPPoE server admission fails. Dial again after confirmation of the PPPoE settings.
232	Access to the DNS server has failed. Check the PPPoE DNS settings.
233	Connection to the remote party via DNS disabled. Dial using IP address.
234	Dialing the same address is invalid.
235	Regarded as a secondary terminal as the number of lines for ISDN configuration is different.
236	Regarded as a secondary terminal as Far End Camera Control is set to Off.
237	Check the line interface or the IP address is set correctly.
238	The conference could not start because the encryption feature at the near-end side was disabled.
239	The conference could not start because the encryption feature at the far-end side was disabled.
240	The conference could not start because the signal encryption method at the near-end side differed from that of the far-end side.
241	The standard encryption videoconference with SIP connection is not available.
242	The Proprietary encryption videoconference with ISDN connection is not available.
243	Connection with the current communication mode is not available via the specified line interface.
244	Disconnected due to failure to receive packet from remote site.

Troubleshooting

If the Communication System does not function correctly, check the following.

Symptom	Cause	Solution
The power is not turned on.	The power switch is not set to on.	Press the power switch to turn on the power of the system (page 34).
	The batteries in the Remote Commander are low or dead.	Replace the batteries with new ones (page 30).
The Remote Commander does not operate.	Pairing with the Remote Commander fails.	Perform pairing of the Remote Commander with the Communication System (page 31).
No sound or the volume is very low.	The volume of the system is too low.	Adjust the sound volume by pressing the VOLUME +/- buttons on the Remote Commander (page 37).
	The microphone on the remote party is turned off.	Ask the remote party to turn on the microphone.
	Audio input is not selected properly.	<ul style="list-style-type: none"> Set up "Input Select (MIC)" on the Basic Setup1 page of the Audio setup menu properly (page 63). Set up "Audio Input" properly on the Basic Setup1 page of the Audio setup menu (page 62).
	The microphone or external equipment is not connected correctly.	Check the connection (pages 153 and 158).
Picture is blurred.	Manual focus is selected but picture remains blurred.	Adjust the focus (page 131).
	When auto focus is selected, the background is too bright, contrast is too high, or the background or the participants' clothes contain fine line patterns.	Select manual focus and adjust manually (page 131).
No picture.	The selected picture source is not tuned on.	Turn on the selected video equipment.
	Video input is not selected properly.	Select the video input properly (page 132).
	The selected picture source is not correctly connected to the system.	Check the connections (page 158).
	A voice meeting is held.	This is not a malfunction.
	Movement of the camera is prevented.	Turn off the system, then turn it on again.

Symptom	Cause	Solution
No connection.	Wrong number was dialed.	Check the entered number.
	The setting of “Line I/F” is not correct (when using direct dialing).	Set “Line I/F” to correct interface referring to “Calling a Remote Party” (page 100).
	The registered items in the Phone Book are not correct.	Register the party correctly referring to “Registering a Remote Party – Phone Book” (page 112).
	Some of the system settings are not correct.	Set the system settings correctly referring to “Registering Local Information” (page 54).
	The IP address and network mask are not set correctly (when using LAN).	Ask the system administrator to set them correctly (page 66).
	The LAN or ISDN cable is disconnected.	Connect correctly (pages 27, 28).
	The LAN or ISDN cable is connected to the incorrect connector.	Connect correctly (pages 27, 28).
	The LAN or ISDN cable is down.	Replace the cable with a new one.
	The cable exclusively designed for the ISDN connection is used for LAN connection (when using LAN).	Use the cable for LAN connection.
	Incorrect type of cable (cross or straight cable) is used for the LAN or ISDN connection.	Use the correct type of cable.
	The DSU is turned off (when using ISDN).	Turn on the DSU.
	If you disconnect the communication with an abnormal procedure, e.g., unplugging an ISDN cable or turning off the system during communication, you may not connect to the ISDN line for a while (when using ISDN).	Turn off the power of the system and wait for a few minutes before turning it on again.
	If you repeat plugging/unplugging or turning on/off, you may not connect to the network for a while (when using LAN).	Turn off the power of the system and wait for a few minutes before turning it on again.
	LAN connection timeout (when using LAN).	Try again later.
	Packet for communication is not acceptable under the current LAN environment (when using LAN).	Consult with the system administrator so that the packet for Communication becomes acceptable under your LAN environment.
The remote terminal is not turned on.	Ask the remote party to turn on the terminal.	

Symptom	Cause	Solution
No connection.	It takes a long time for the remote party to be able to answer from the standby mode.	Ask the remote party to cancel the standby mode.
	The remote party is in communication with another party.	Call the remote party after they end the communication with another party.
	Answering the call is not permitted by the remote terminal as it is operating for setups, etc.	Ask the remote party to permit answering a call.
	The remote terminal is not set to auto answer mode.	Ask the remote party to set the terminal to auto answer mode, or to answer a call manually.
	The ISDN telephone numbers are not set up in the remote terminal (when using bonding).	Ask the remote party to set up "Area Code" and "Local Number" in the ISDN Setup menu correctly (page 72).
	The eighth digit and up of the ISDN telephone numbers are not the same when connecting using bonding (when the remote party uses the communication system of an older model such as the PCS-1600).	Connect without using bonding, or use the ISDN telephone numbers that are the same in the eighth digit and up.
	There is some problem with the remote terminal.	Try to dial the number of another terminal.
	A message appears on the screen.	See "On-Screen Messages" (page 222).
Still pictures or the Phone Book cannot be saved to the "Memory Stick."	The write-protect tab on the "Memory Stick" is set to LOCK.	Release the lock (page 243).
	The "Memory Stick" has already been recorded to full capacity.	Use another "Memory Stick."

Specifications

PCS-XL55 HD Visual Communication System

This unit is compliant with ITU-T Recommendations H.320 and H.323.

Motion picture

Operating bandwidth

- 64 Kbps to 4 Mbps (standard, LAN connection)
- 56 Kbps to 768 Kbps (when installing the PCSA-B768S, ISDN connection)
- 56 Kbps to 384 Kbps (when installing the PCSA-B384S, ISDN connection)

Coding H.261/H.263/H.263+/H.263++/H.264
MPEG4 Simple Profile (when using SIP)

Picture elements

- CIF: 352 pixels × 288 lines
- QCIF: 176 pixels × 144 lines
- 4CIF: 704 pixels × 576 lines
- WCIF (W288p): 512 pixels × 288 lines
- W432p: 768 pixels × 432 lines
- W4CIF: 1024 pixels × 576 lines
- 720p: 1280 pixels × 720 lines

Sound

Bandwidth 22 kHz (MPEG4 AAC)
14 kHz (MPEG4 AAC)
7 kHz (G.722 compliant with ITU-T Recommendation)
3.4 kHz (G.711/G.728 compliant with ITU-T Recommendation)

Transmission rate

- 56 Kbps, 64 Kbps (G.711 compliant with ITU-T Recommendation)
- 48 Kbps, 56 Kbps, 64 Kbps (G.722 compliant with ITU-T Recommendation)
- 64 Kbps, 96 Kbps (MPEG4 AAC) (when using LAN)
- 16 Kbps (G.728 compliant with ITU-T Recommendation)
- 48 Kbps (MPEG4 AAC) (when using ISDN)

Network

Multiplexing

Video, audio, data

Frame format

H.221 (compliant with ITU-T Recommendation)

Interface

LAN (standard), 64 Kbps to 4 Mbps
ISDN (BRI), up to 3 lines (when installing the PCSA-B384S)
up to 6 lines (when installing the PCSA-B768S)

Data transmission rate

LSL 1.2 Kbps, 4.8 Kbps, 6.4 Kbps
MLP 6.4 Kbps, 24 Kbps, 32 Kbps
HMLP 62.4 Kbps, 64 Kbps, 128 Kbps

LAN protocol supported

HTTP
Telnet
RTP/RTCP
TCP/UDP
SNMP

Remote control

Far end camera control

H.281 (compliant with ITU-T Recommendation)

Camera

Image device 1/3.2 type, color CMOS image sensor
8,000,000 pixels

Lens f = 2.94 mm (22 mm in 35 mm format)
F = 1:2.8
Horizontal angle: 80.1 degrees
Vertical angle: 62.7 degrees

Focal distance

80 mm

Zoom function

Digital

Auto white balance function built-in

Auto exposure function built-in

Frame rate 30 fps

Display

Size 21.6-inch widescreen
Resolution 1366 × 768 (WXGA)
Viewing angle 176 degrees
Number of colors 16,700,000 colors

Display controller

Input	Internal: Videoconference External RGB: Computer display
RGB mode	640 × 350, 640 × 400, 640 × 480, 800 × 600, 832 × 624, 1024 × 768, 1280 × 720, 1280 × 768, 1280 × 1024

Speakers

Speakers	× 2
----------	-----

Microphone

Frequency range	8 kHz
Directional characteristic	Unidirectional

General

Power requirements	DC 19.5 V
Current consumption	5 A
Operating temperature	5 °C to 35 °C (41 °F to 95 °F)
Operating humidity	20% to 80%
Storage temperature	-20 °C to +60 °C (-4 °F to +140 °F)
Storage humidity	20% to 80% (no condensation)
Dimensions	557 × 410 × 117 mm (W × H × D) (22 × 16 1/4 × 4 3/8 inches) (not including stand) 557 × 456.5 × 214 mm (W × H × D) (22 × 18 × 8 1/2 inches) (including stand)
Mass	Approx. 8.2 kg (18 lb 1.2 oz)
Supplied accessories	PCS-RF1 RF Remote Commander (1) Size AA (R6) batteries for RF Remote Commander (2) AC adaptor (1) Power cord (1) CD-ROM (1) Before Using this Unit (1) Quick Connection Guide/Remote Commander Guide (1) Warranty booklet (1) User registration form (1) (Japan only)

PCS-RF1 Remote Commander (Supplied)

Signal format	Compliant with IEEE802.15.4
Control	DC 3V using two size AA (R6) batteries

VGP-AC19V54 AC Adaptor

Power requirements	100 to 240 V AC, 50/60 Hz, 2.0 A
Output	DC 19.5 V, 7.7 A
Operating temperature	5 °C to 35 °C (41 °F to 95 °F)
Operating humidity	20% to 80%
Storage temperature	-20 °C to +60 °C (-4 °F to +140 °F)
Storage humidity	20% to 80% (no condensation)
Dimensions	160 × 80 × 40 mm (W × H × D) (6 3/8 × 3 1/4 × 1 3/8 inches) (not including projections)
Mass	Approx. 700 g (1 lb 8.7 oz)

PCS-A1 Microphone (Optional)

Bandwidth	13 kHz
Directional characteristic	Omnidirectional
Dimensions	74 × 16 × 93 mm (W × H × D) (3 × 21/32 × 3 3/4 inches)
Mass	Approx. 170 g (6.0 oz)
Power	Plug in power
Cable length	8 m (26.2 ft)

PCSA-A3 Microphone (Optional)

Bandwidth	13 kHz
Directional characteristic	Unidirectional
Dimensions	68 × 16 × 96 mm (W × H × D) (2 3/4 × 21/32 × 3 7/8 inches)
Mass	Approx. 200 g (7.1 oz)
Power	Plug in power
Cable length	8 m (26.2 ft)

PCSA-B384S ISDN Unit (Optional)

Power requirements	DC 19.5 V
Current consumption	0.3 A
Operating temperature	5 °C to 35 °C (41 °F to 95 °F)
Operating humidity	20% to 80%
Storage temperature	-20 °C to +60 °C (-4 °F to +140 °F)
Storage humidity	20% to 80% (no condensation)
Dimensions	166 × 34 × 128 mm (W × H × D) (6 5/8 × 1 3/8 × 5 1/8 inches) (not including projections except for the feet)
Mass	Approx. 400 g (14 oz)
Supplied accessories	Interface cable (5 m) (16.4 ft) (1) Operating Instructions (1) Warranty booklet (1)

PCSA-B768S ISDN Unit (Optional)

Power requirements	DC 19.5 V
Current consumption	0.5 A
Operating temperature	5 °C to 35 °C (41 °F to 95 °F)
Operating humidity	20% to 80%
Storage temperature	-20 °C to +60 °C (-4 °F to +140 °F)
Storage humidity	20% to 80% (no condensation)
Dimensions	166 × 34 × 128 mm (W × H × D) (6 5/8 × 1 3/8 × 5 1/8 inches) (not including projections except for the feet)
Mass	Approx. 400 g (14 oz)
Supplied accessories	Interface cable (5 m) (16.4 ft) (1) Operating Instructions (1) Warranty booklet (1)

PCSA-DSG80 HD Data Solution Software (Optional)

Dimensions	72.5 × 11 × 20 mm (W × H × D) (2 7/8 × 7/16 × 13/16 inches)
Mass	Approx. 10 g (0.35 oz)
Supplied accessories	Serial number seal (1) Operating Instructions (1)

Design and specifications are subject to change without notice.

Notes

- Always make a test recording, and verify that it was recorded successfully. SONY WILL NOT BE LIABLE FOR DAMAGES OF ANY KIND INCLUDING, BUT NOT LIMITED TO, COMPENSATION OR REIMBURSEMENT ON ACCOUNT OF FAILURE OF THIS UNIT OR ITS RECORDING MEDIA, EXTERNAL STORAGE SYSTEMS OR ANY OTHER MEDIA OR STORAGE SYSTEMS TO RECORD CONTENT OF ANY TYPE.
- Always verify that the unit is operating properly before use. SONY WILL NOT BE LIABLE FOR DAMAGES OF ANY KIND INCLUDING, BUT NOT LIMITED TO, COMPENSATION OR REIMBURSEMENT ON ACCOUNT OF THE LOSS OF PRESENT OR PROSPECTIVE PROFITS DUE TO FAILURE OF THIS UNIT, EITHER DURING THE WARRANTY PERIOD OR AFTER EXPIRATION OF THE WARRANTY, OR FOR ANY OTHER REASON WHATSOEVER.

Sales and distribution of MPEG-4 Visual encoders/decoders

THIS PRODUCT IS LICENSED UNDER THE MPEG-4 VISUAL PATENT PORTFOLIO LICENSE FOR THE PERSONAL AND NON-COMMERCIAL USE OF A CONSUMER FOR

- (i) ENCODING VIDEO IN COMPLIANCE WITH THE MPEG-4 VISUAL STANDARD (“MPEG-4 VIDEO”) AND/OR
- (ii) DECODING MPEG-4 VIDEO THAT WAS ENCODED BY A CONSUMER ENGAGED IN A PERSONAL AND NON-COMMERCIAL ACTIVITY AND/OR WAS OBTAINED FROM A VIDEO PROVIDER LICENSED BY MPEG LA TO PROVIDE MPEG-4 VIDEO.

NO LICENSE IS GRANTED OR SHALL BE IMPLIED FOR ANY OTHER USE. ADDITIONAL INFORMATION INCLUDING THAT RELATING TO PROMOTIONAL, INTERNAL AND COMMERCIAL USES AND LICENSING MAY BE OBTAINED FROM MPEG LA, LLC. SEE [HTTP://WWW.MPEGLA.COM](http://WWW.MPEGLA.COM)

MPEG LA is offering licenses for

- (i) manufacturing/sales of any storage media storing MPEG-4 Visual video information
- (ii) distribution/broadcasting of MPEG-4 Visual video information in any manner (such as online video distribution service, internet broadcasting, TV broadcasting).

Other usage of this product may be required to obtain license from MPEG LA.

Please contact MPEG LA for any further information. MPEG LA, L.L.C., 250 STEELE STREET, SUITE 300, DENVER, COLORADO 80206, <http://www.mpegla.com>

Sales and distribution of MPEG-4 AVC (3-1) encoders/decoders

THIS PRODUCT IS LICENSED UNDER THE AVC PATENT PORTFOLIO LICENSE FOR THE PERSONAL AND NON-COMMERCIAL USE OF A CONSUMER TO

- (i) ENCODE VIDEO IN COMPLIANCE WITH THE AVC STANDARD (“AVC VIDEO”) AND/OR
- (ii) DECODE AVC VIDEO THAT WAS ENCODED BY A CONSUMER ENGAGED IN A PERSONAL AND

NON-COMMERCIAL ACTIVITY AND/OR WAS OBTAINED FROM A VIDEO PROVIDER LICENSED TO PROVIDE AVC VIDEO. NO LICENSE IS GRANTED OR SHALL BE IMPLIED FOR ANY OTHER USE. ADDITIONAL INFORMATION MAY BE OBTAINED FROM MPEG LA, L.L.C. SEE [HTTP://MPEGLA.COM](http://MPEGLA.COM)

Acceptable RGB Input/Output Signals

PCS-XL55 HD Visual Communication System (RGB OUT)

Picture element	Signal format	fH (kHz)	fV (Hz)	Sync	
1024 × 768	XGA VESA 60 Hz	48.363	60.004	H-neg	V-neg
1280 × 1024	SXGA VESA 60 Hz	63.981	60.02	H-pos	V-neg
1280 × 768	WXGA VESA 60 Hz	47.776	59.870	H-neg	V-pos

PCS-XL55 HD Visual Communication System (RGB IN)

Acceptable signals during presentation mode

Picture element	Signal format	fH (kHz)	fV (Hz)	Sync	
640 × 480	VGA mode 3	31.469	59.94	H-neg	V-neg
	VGA VESA 72 Hz	37.861	72.809	H-neg	V-neg
	VGA VESA 75 Hz	37.5	75	H-neg	V-neg
	VGA VESA 85 Hz	43.269	85.008	H-neg	V-neg
800 × 600	SVGA VESA 56 Hz	35.156	56.25	H-pos	V-pos
	SVGA VESA 60 Hz	37.879	60.317	H-pos	V-pos
	SVGA VESA 72 Hz	48.077	72.188	H-pos	V-pos
	SVGA VESA 75 Hz	46.875	75	H-pos	V-pos
	SVGA VESA 85 Hz	53.674	85.061	H-pos	V-pos
1024 × 768	XGA VESA 60 Hz	48.363	60.004	H-neg	V-neg
	XGA VESA 70 Hz	56.476	70.069	H-neg	V-neg
	XGA VESA 75 Hz	60.023	75.029	H-pos	V-pos
	XGA VESA 85 Hz	68.667	84.997	H-pos	V-pos
1280 × 1024	SXGA VESA 60 Hz	63.981	60.02	H-pos	V-pos

Acceptable signals during computer display

Picture element	Signal format	fH (kHz)	fV (Hz)	Sync	
640 × 350	VGA-1	31.469	70.086	H-pos	V-neg
	VESA 85	37.861	85.080	H-pos	V-neg
640 × 400	NEC PC98	24.823	56.416	H-neg	V-neg
	VGA-2	31.469	70.086	H-neg	V-pos
	VESA 85	37.861	85.080	H-neg	V-pos
640 × 480	VGA mode 3	31.469	59.94	H-neg	V-neg
	VGA VESA 72 Hz	37.861	72.809	H-neg	V-neg
	VGA VESA 75 Hz	37.5	75	H-neg	V-neg
	VGA VESA 85 Hz	43.269	85.008	H-neg	V-neg
	Mac 13	35.000	66.667	H-neg	V-neg
800 × 600	SVGA VESA 56 Hz	35.156	56.25	H-pos	V-pos
	SVGA VESA 60 Hz	37.879	60.317	H-pos	V-pos
	SVGA VESA 72 Hz	48.077	72.188	H-pos	V-pos
	SVGA VESA 75 Hz	46.875	75	H-pos	V-pos
	SVGA VESA 85 Hz	53.674	85.061	H-pos	V-pos
832 × 624	Mac 16	49.724	74.550	H-neg	V-neg
1024 × 768	XGA VESA 60 Hz	48.363	60.004	H-neg	V-neg
	XGA VESA 70 Hz	56.476	70.069	H-neg	V-neg
	XGA VESA 75 Hz	60.023	75.029	H-pos	V-pos
	XGA VESA 85 Hz	68.667	84.997	H-pos	V-pos
1280 × 768	1280 × 768/60	47.776	59.870	H-neg	V-pos
1280 × 720	1280 × 720/60	44.772	59.855	H-neg	V-pos
1280 × 1024	SXGA VESA 60 Hz	63.981	60.02	H-pos	V-pos

Pin Assignments

100BASE-TX/10BASE-T jack



Modular jack

Pin	Signal	Description
1	TPOPTX+	Transmit+
2	TPONTX-	Transmit-
3	TPIPRX+	Receive+
4	NC	—
5	NC	—
6	TPINRX-	Receive-
7	NC	—
8	NC	—

ISDN UNIT connector



Pin	Signal	Description
1	GND	Ground
2	19.5V	19.5V
3	DCLK+	Clock+
4	DCLK-	Clock-
5	DR+	Receive data+
6	DR-	Receive data-
7	FS+	Frame sync+
8	FS-	Frame sync-
9	DX+	Transmit data+
10	DX-	Transmit data-
11	RX	Serial receive data
12	TX	Serial transmit data
13	19.5V	19.5V
14	GND	Ground

RGB OUT/IN connector

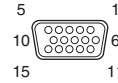

Mini D-sub 15-pin (female)

Pin	Signal	Description
1	RED	R (red)
2	GREEN	G (green)
3	BLUE	B (blue)
4	NC	—
5	GND	Ground
6	RED.GND	R (red) signal ground
7	GREEN.GND	G (green) signal ground
8	BLUE.GND	B (blue) signal ground
9	NC	—
10	SYNC.GND	Sync signal ground
11	NC	—
12	NC	—
13	HSYNC	Horizontal sync
14	VSYNC	Vertical sync
15	NC	—

Pin Assignments on Optional Board Connectors

ISDN 1-3 jacks (PCSA-B384S) ISDN 1-6 jacks (PCSA-B768S)



Modular jack

Pin	Signal	Description
1	NC	–
2	NC	–
3	TA	Transmit+
4	RA	Receive+
5	RB	Receive–
6	TB	Transmit–
7	NC	–
8	NC	–

TERMINAL connector (PCSA-B384S/PCSA-B768S)



Pin	Signal	Description
1	GND	Chassis ground
2	19.5V	19.5V
3	DCLK+	Clock+
4	DCLK–	Clock–
5	DR+	Transmit data+
6	DR–	Transmit data–
7	FS+	Frame sync+
8	FS–	Frame sync–
9	DX+	Receive data+
10	DX–	Receive data–
11	TX	Serial transmit data
12	RX	Serial receive data

Pin	Signal	Description
13	19.5V	19.5V
14	GND	Ground

Screen Size during Two-Picture Display

Output screen size

Main picture				Sub picture			
Type	Aspect ratio	Horizontal size	Vertical size	Type	Aspect ratio	Horizontal size	Vertical size
Computer display	4:3	960	720	Videoconfer- ence display	16:9	320	180
Computer display	5:4	960	768	Videoconfer- ence display	16:9	320	180
Computer display	5:3	960	576	Videoconfer- ence display	16:9	320	180
Computer display	8:5	960	600	Videoconfer- ence display	16:9	320	180
Computer display	640:350	960	525	Videoconfer- ence display	16:9	320	180
Computer display	16:9	960	540	Videoconfer- ence display	16:9	320	180
Videoconfer- ence display	16:9	960	540	Computer display	4:3	320	240
Videoconfer- ence display	16:9	960	540	Computer display	5:4	320	256
Videoconfer- ence display	16:9	960	540	Computer display	5:3	320	192
Videoconfer- ence display	16:9	960	540	Computer display	8:5	320	200
Videoconfer- ence display	16:9	960	540	Computer display	640:350	320	175
Videoconfer- ence display	16:9	960	540	Computer display	16:9	320	180

Appendix

Two-Picture Display Example

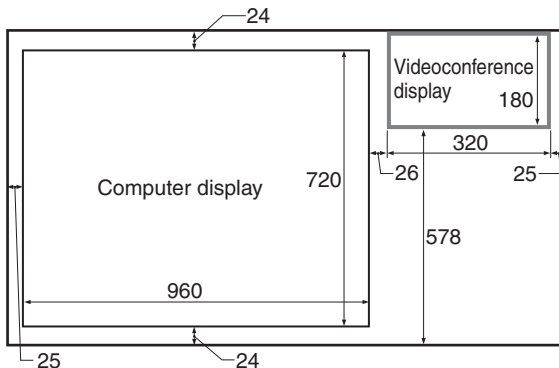

Gray frame (window picture frame): 5 dots for top, bottom, left, and right

Display Switching Controls

This section describes how to transition between screen layouts. The explanation for the videoconference screen uses the Full screen and Picture-and-Picture layouts as an example. This explanation for the Picture-and-Picture display can also be applied to the Side-by-Side and Picture-in-Picture layouts.

Screen displays are represented as follows in this explanation.



= Local camera image



= Remote camera image

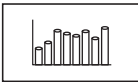

= Presentation from remote site

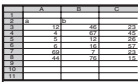

= Computer display

Layout Controls during Videoconference Display

Use the LAYOUT, F1, and F2 buttons on the Remote Commander to perform layout controls. Transitions between layouts will differ depending on whether a second monitor is used and whether presentation mode is in progress.

Single monitor transitions

During communications

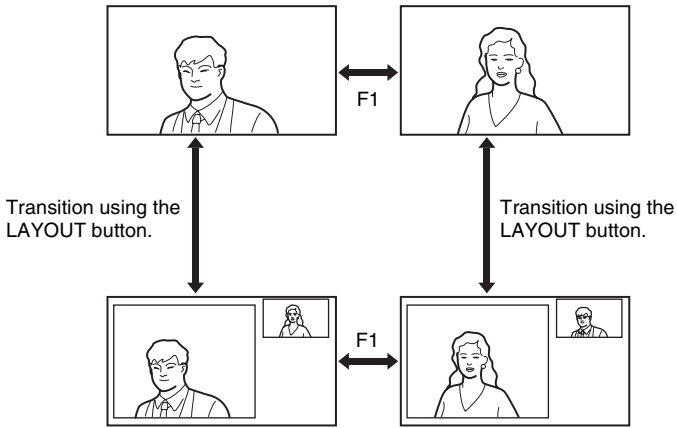

During presentations

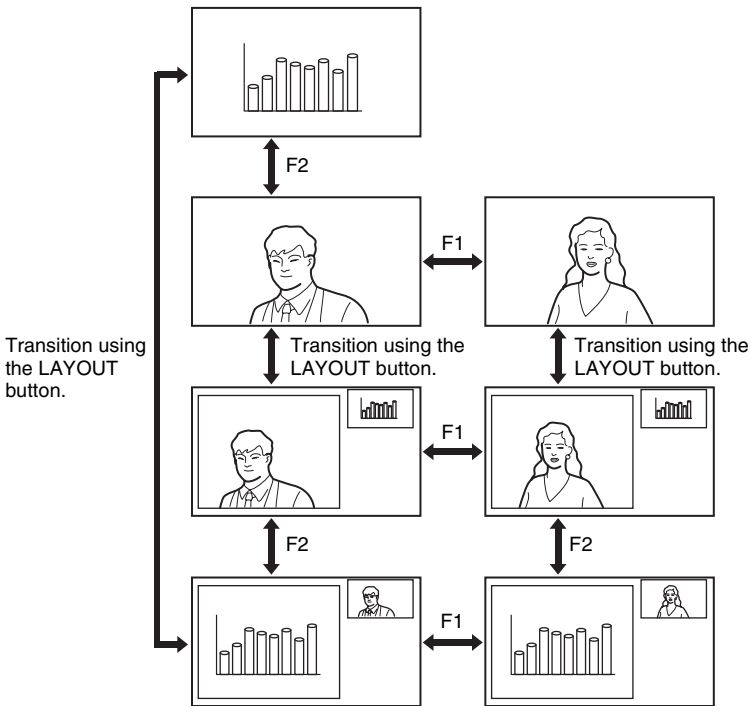

Dual monitor transitions

During communications

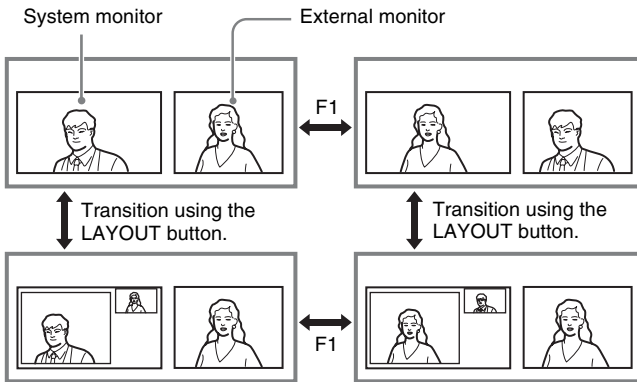

During presentations

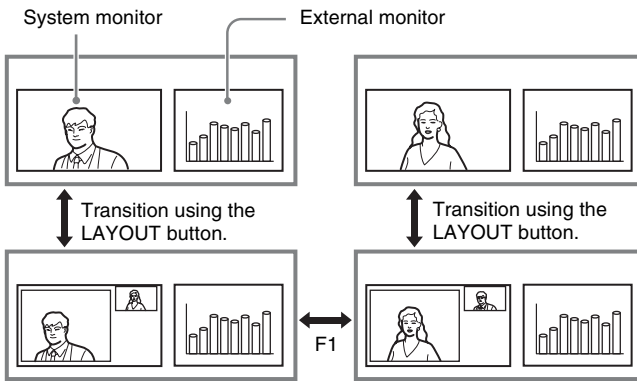

Layout Controls between Videoconference and Computer Picture Displays

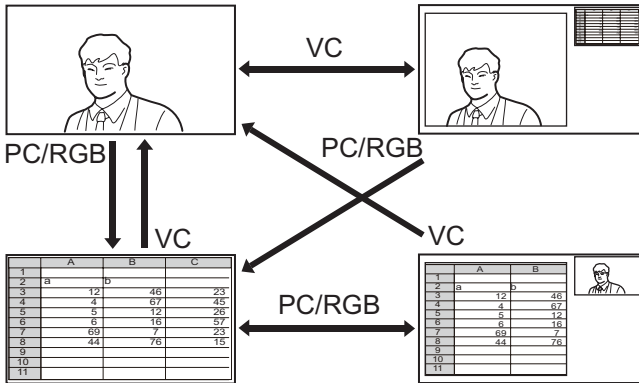

Note

The actual position of the remote camera image in the above diagram is as follows.

- During single monitor display: The display is based on the layout settings configured for videoconferences.
- During dual monitor display: The display is identical to the videoconference layout displayed on the monitor of the system.

Appendix

Layout Control Examples

To view the computer picture and remote camera images on a single monitor

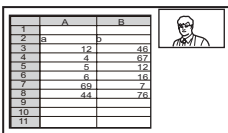

Press the PC/RGB button on the Communication System twice during communication with the remote party, and the monitor will switch to a two-picture display with the computer picture as the main picture.

To view the computer picture, remote camera images, and a remote presentation on dual monitors

System monitor

	A	B
1		
2	a	b
3	12	45
4	4	67
5	5	12
6	6	16
7	69	7
8	44	76
9		
10		
11		



External monitor

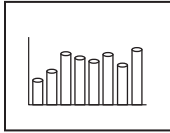

Press the PC/RGB button on the Communication System twice while receiving a presentation from the remote party, and the monitor will switch to a two-picture display with the computer picture as the main picture.

To view the computer picture, local camera images, and remote camera images on dual monitors

System monitor

	A	B
1		
2	a	b
3	12	45
4	4	67
5	5	12
6	6	16
7	69	7
8	44	76
9		
10		
11		



External monitor



- 1** Press the LAYOUT button on the Remote Commander during communication with the remote party.
The layout menu appears.
- 2** Press the F1 button.
The displays of the two monitors switch, with the monitor displaying the local camera image now displaying the remote camera image and vice versa.
- 3** Press the PC/RGB button on the Communication System.
The monitor will switch to a two-picture display with the computer picture as the main picture.

List of Port Numbers Used on the PCS-XL55

For point-to-point connection

Signal	Port number	Type
RAS	1719	UDP
Gatekeeper Discovery	224.0.1.41:1718	UDP Multicast
Q.931 (dial)	2253-2263	TCP
Q.931 (answer)	1720	TCP
H.245	2253-2263	TCP
Audio RTP	49152-49159	UDP
Audio RTCP	49152-49159	UDP
Video RTP	49152-49159	UDP
Video RTCP	49152-49159	UDP
FECC RTP	49152-49159	UDP
FECC RTCP	49152-49159	UDP
SIP	5060	UDP/TCP
Auto bandwidth detection	51234-51235	UDP/TCP

For multipoint connection

Signal	Port number of the first point	Port numbers of the second point	Type
RAS	1719		UDP
Gatekeeper Discovery	224.0.1.41:1718		UDP Multicast
Q.931 (dial)	2253-2263		TCP
Q.931 (answer)	1720		TCP
H.245	2253-2263		TCP
Audio RTP	49152-49159	49172-49179	UDP
Audio RTCP			
Video RTP			
Video RTCP			
FECC RTP			
FECC RTCP			
SIP	5060		UDP/TCP
Auto bandwidth detection	51234-51235		UDP/TCP

Note

The port numbers for RTCP that can be set are 49152 to 65535.

Videoconferencing Room Layout

Layout example

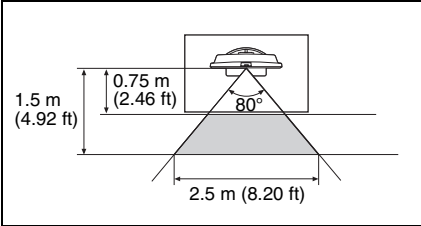

Camera Range

■ represents the shooting area of the camera when the zoom has been extended fully. Use the measurements below as a guide for the layout of your videoconference room.

Top view (horizontal range at maximum zoom-out)

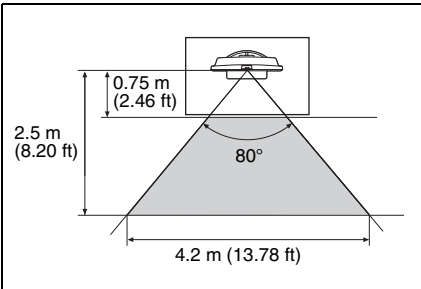

Side view (vertical range at maximum zoom-out)

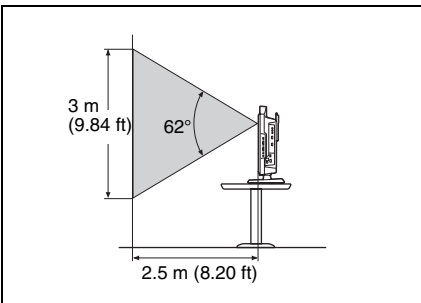

Layout Considerations

- Avoid having large, moving objects, especially people, behind the participants, as the quality of the picture transmitted to the remote party will deteriorate.
- Do not seat participants in front of a wall with fine stripe patterns.
- Choose a room where echo will not occur.
- Do not install the system near noise sources such as air conditioners or copy machines.
- Avoid placing the system in a room where there are the speakers used for an in-house broadcasting system.

Lighting Considerations

Do not point the camera toward a window where sunlight comes in as back lighting may decrease the contrast. If it is necessary, cover the window with a thick curtain.

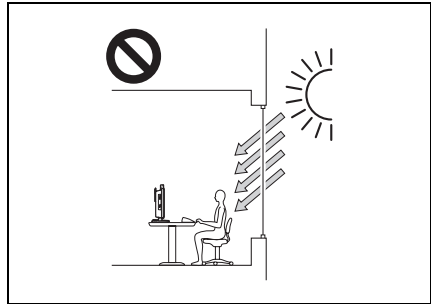

Adjust room lighting so that it falls on the participants. Avoid direct light on the display.

Light intensity on faces should be about 300 lux or more.

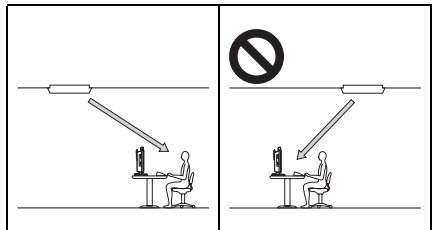

“Memory Stick” Media

Use a “Memory Stick PRO” or “Memory Stick PRO Duo” for the Visual Communication System.

Notes on using “Memory Stick” media

- When you set the “Memory Stick” erasure prevention switch to “LOCK”, data cannot be recorded, edited, or deleted.

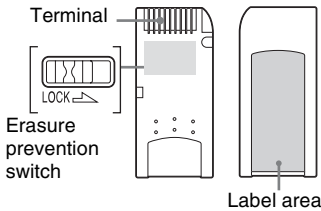

The position and shape of the write-protect switch may differ between the various types of “Memory Stick”.

- Do not remove the “Memory Stick” while it is reading or writing data.
- Data may be damaged if:
 - The “Memory Stick” is removed or the unit is turned off while reading or writing.
 - You use the “Memory Stick” in a location subject to the effects of static electricity or electric noise.
- We recommend that you back up important data recorded on the “Memory Stick”.
- Do not affix anything other than the supplied label to the “Memory Stick” label area.
- Affix the label so that it does not stick out beyond the label area.
- When storing or carrying a “Memory Stick”, keep it in its original case.
- Do not touch the terminal of the “Memory Stick” with anything, including your fingers or metallic objects.
- Do not strike, bend, or drop the “Memory Stick”.
- Do not disassemble or modify the “Memory Stick”.

- Do not allow the “Memory Stick” to get wet.
- Do not use or store the “Memory Stick” in locations subject to:
 - Extreme heat, such as in a closed car parked in the sun.
 - Direct sunlight.
 - Humidity or corrosive substances.

About data

- When you set the “Memory Stick” erasure prevention switch to “LOCK”, data such as images and mails cannot be recorded, edited, or deleted. Be sure to unlock the switch before transferring or copying data on the unit to the “Memory Stick”, or erasing data on the “Memory Stick”.
- We recommend that you make a backup copy of important data on another “Memory Stick” or on a hard disk using a computer.

Notes on using “Memory Stick Duo”

- Use a pointed object, such as a ballpoint pen, to move the “Memory Stick Duo” write-protect switch.
- Do not write forcefully on the “Memory Stick Duo” memo area.

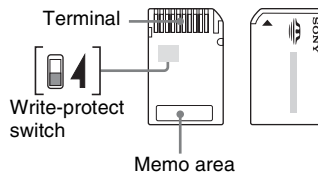

Format that can be used with this unit

The unit can use the picture files recorded on a “Memory Stick” in the following format:

- Image files (DCF-compatible) compressed in the JPEG (Joint Photographic Experts Group) format (extension: .jpg)

Memory Stick™, Memory Stick Duo™, Memory Stick PRO™, Memory Stick PRO Duo™ and  are trademarks of Sony Corporation.

Phenomena Specific to CMOS Image Sensors

The following phenomena that may appear in images are specific to CMOS (Complementary Metal Oxide Semiconductor) image sensors. They do not indicate malfunctions.

White flecks

Although the CMOS image sensors are produced with high-precision technologies, fine white flecks may be generated on the screen in rare cases, caused by cosmic rays, etc.

This is related to the principle of CMOS image sensors and is not a malfunction.

The white flecks especially tend to be seen in the following cases:

- when operating at a high environmental temperature
- when you have raised the gain (sensitivity)

This phenomenon may be improved when you turn the power of the System off and on.

Aliasing

When fine patterns, stripes, or lines are shot, they may appear jagged or flicker.

Glossary

ARC

An abbreviation for Adaptive Rate Control. Technology which automatically lowers a video streaming bitrate against network congestion.

ARQ

An abbreviation for Automatic Repeat reQuest. Error control method in which the receiver requests a retransmission from the transmitter when a packet loss occurs.

Auto Bandwidth Detection

Detects the network bandwidth and others before communication. By using this value for the QoS function, optimum QoS control is available from the beginning of the communication.

Bonding*

Bonding is one of the Inverse Multiplexing methods allowing the connection of the communication system with multiple ISDN lines. Dialing the first ISDN line enables you to connect all other lines. Dialing the second and later lines is done automatically by the communication between the communication systems on both sites. To use bonding, it is required that both communication systems be equipped with the bonding function and that “Area Code” and “Local Number” in the ISDN Setup menu of the answering site be set correctly. As the communication between the systems when using the bonding function is made via the ISDN numbers of the answering site, the “Area Code” and “Local Number” settings in the ISDN Setup menu are not essential at the dialing site.

* Bonding (Bandwidth on Demand Interoperability Group) is a registered trademark of THE BONDING CONSORTIUM.

BRI

An abbreviation for Basic Rate Interface. Basic interface standardized by the ITU-T. Single ISDN has two B channels and one D channel.

Codec

An abbreviation for Coder-Decoder. An integrated device of a coder that converts an analog audio/video signal to a digital data stream and compresses it, and a decoder for expanding to restore the original analog signal.

DHCP

An abbreviation for Dynamic Host Configuration Protocol. Manages IP addresses in the network.

DNS

An abbreviation for Domain Name System. Defines the domain name system.

Echo Cancellor

Device to eliminate echo that occurs when transmitting audio.

FEC

An abbreviation for Forward Error Correction. Error control method in which the receiver can correct errors without requesting a retransmission from the transmitter.

Frame rate

The number of frames which can be encoded/decoded in one second.

G.711

Audio encoding/decoding format recommended by the ITU-T. A phone bandwidth audio signal is converted to a digital signal with a data rate of 64 Kbps. It can be transmitted with a data rate of 56 Kbps.

G.722

Audio encoding/decoding format recommended by the ITU-T. A 7-kHz bandwidth audio signal is converted to a digital signal with a data rate of 48 Kbps, 56 Kbps or 64 Kbps.

G.728

Audio encoding/decoding format recommended by the ITU-T. A phone bandwidth audio signal is converted to a digital signal with a data rate of 16 Kbps.

Gatekeeper

Controls the access of H.323 communication devices on a network. Administers the zone, access limitation, audio/video bandwidth, and alias etc.

H.221

Frame structure for a digital channel in audiovisual teleservices.

H.239

ITU-T standard for sharing data and presentations with video. This supports the dual video presentation mode, enabling endpoints to receive and transmit video and presentation data simultaneously.

H.261

Video codec for audio/visual services as $p \times 64$ Kbps. A standard that defines a video coding algorithm, picture format and error correcting technology for communication between different manufacturers' video codecs.

H.263

A video coding algorithm based on the H.261 standard. This format enables communication via a lower bit rate.

H.263+

Video encoding/decoding format based on the H.263 standard, added by the Annex I to T (I, J, K T), that allows enhanced picture quality and error resistance. Normally, this format is a profile used with a combination of some of the Annex for H.263/H.263+.

H.264

A video coding algorithm standardized by the ITU-T in May 2003. This format realizes high-quality picture via a lower bit rate. It provides an equal picture quality via half as low bit rate as the H.263 format. The H.264 format is also called as MPEG4 Advanced Video Coding (AVC).

H.320

A standard for communication between different communication systems.

H.323

This enables communications on the non-Qos (Quality of Service) LAN.

HD

An abbreviation for High Definition. High Definition television provides a high-resolution and high-quality picture. There are 1080i and 720P HD formats.

HMLP

See "MLP".

HOP

Number of routers that have passed through to reach the remote party.

I-MUX

An abbreviation for Inverse Multiplexer. This protocol allows you to transmit the data at 384 Kbps via 6B-channel.

ISDN

An abbreviation for Integrated Services Digital Network. This is a communication protocol by CCITT on transmission of integrated voice, video, and data. Bandwidths include basic (64 Kbps) and primary rate (1.544 and 2.048 Mbps).

ITU-T

An abbreviation for International Telecommunication Union, Telecommunications.

Lip synchronization

A function that synchronizes sound with motion. Sound processing is much faster than motion processing, thus sound and motion sometimes get out of step with each other.

MLP

Data communication is also available during communication of video/audio signals between the communication systems. The MLP or HMLP is a protocol for data communication such as NetMeeting. Using the HMLP protocol allows faster data transmission.

**NTSC**

An abbreviation for National TV Standards Committee. NTSC is the television system in use in Japan, the United States, etc. It is not compatible with the PAL system.

PAL

An abbreviation for Phase Alternation Line. PAL is the television system in use in Europe, China, etc. It is not compatible with the NTSC system.

P in P

An abbreviation for “Picture in Picture.” This is a function which allows you to monitor your own party on a small window on your TV monitor.

QoS

An abbreviation for Quality of Service. QoS reserves a bandwidth for specific communication in the network and guarantees a given communication speed.

SIP

An acronym for Session Initiation Protocol. SIP is a communication control protocol used for Internet telephony, instant messaging, etc.

SNMP

An abbreviation for Simple Network Management Protocol. This protocol is for management information between the management station and the managed terminals. This enables the monitoring of Sony Communication Systems.

SPID

An abbreviation for Service Profile ID.

Streaming

A technology that allows audio and video data to be played back as it is downloaded for real time viewing over a network, such as the Internet.

Sub-address

An identification number given to devices sharing a common ISDN line.

TOS

Inputting the information data in the TOS field of the IP address allows the communication system to judge the packet transmission priority, etc. It also enables change of path according to the types of service (Delay or Size).

Menu Configuration

The menus of the HD Visual Communication System are configured as described below.

For detailed information, see pages in parentheses. The initial settings of each item are **bolded**.

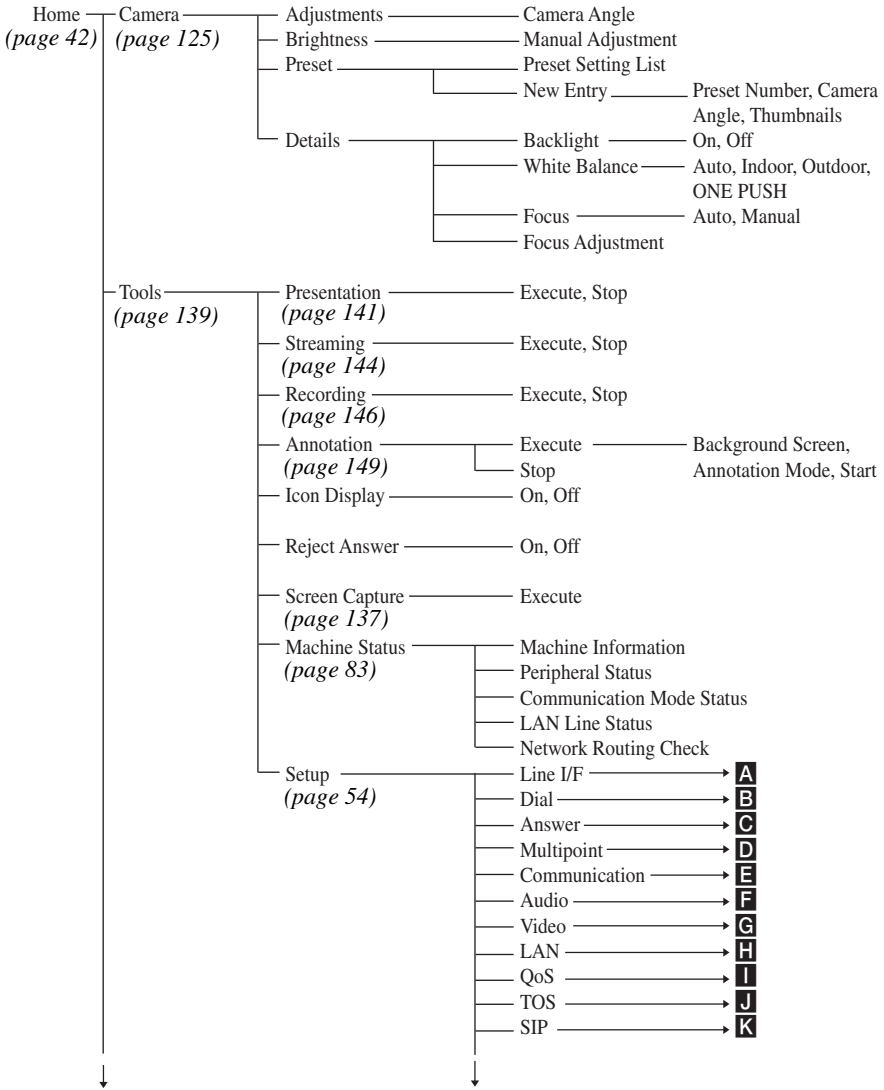

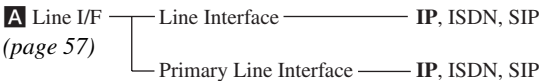
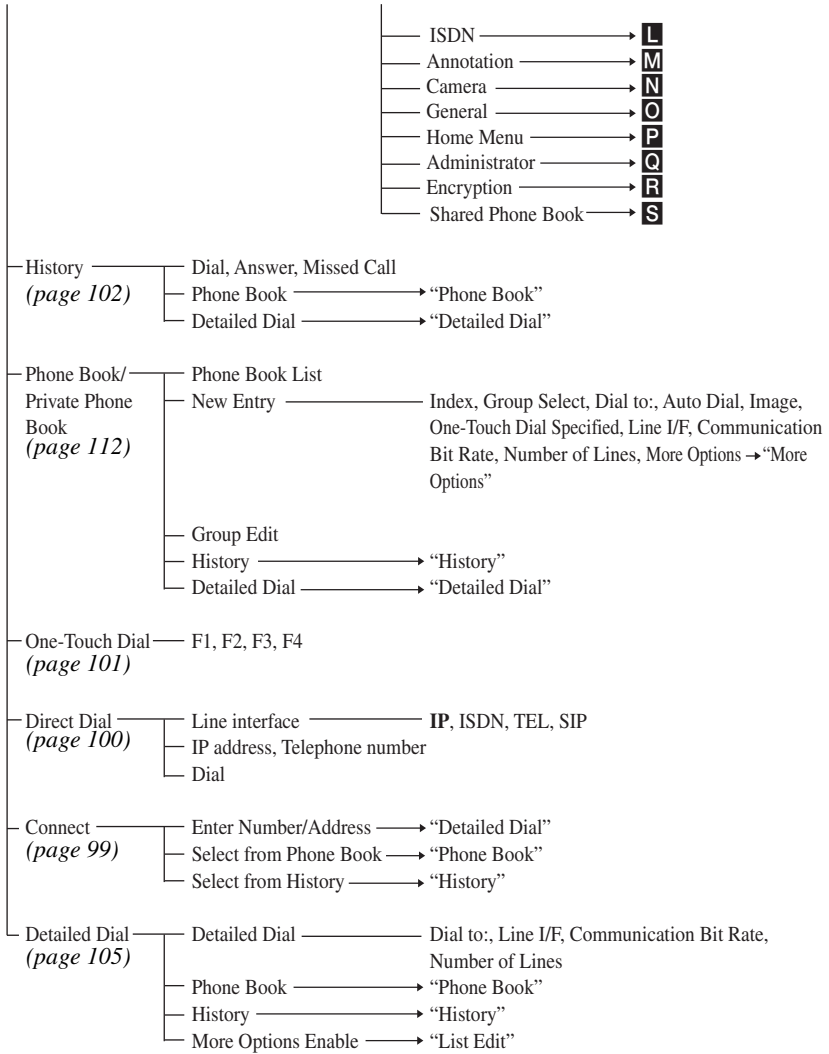

B Dial (page 57)	— Telephone Mode ———	Auto , G.711 μ -law, G711A-law
	— More Options Enable —	Off , On
	— User Name Input ———	Off , On
	— Prefix —————	Prefix-None , Prefix-A, Prefix-B, Prefix-C
	— Prefix-A	
	— Prefix-B	
	— Prefix-C	
	— Select LAN Prefix ———	Disable , Enable
	— LAN Prefix	

C Answer (page 58)	— Auto Answer ———	On, Off
	— ISDN MSN ———	Off , On
	— Mic on Answer ———	On , Off
	— Reject Answer ———	On, Off

D Multipoint (page 58)	— Mlultipoint Mode —	AUTO , On
	— Broadcast Mode —	Split , Voice Activate, Voice Activate (720P)
	— Split —————	Four-screen Mosaic , Six-screen Mosaic

E Communication (page 59)	IP (Communication)	Individual Settings for Transmission/Reception Individual Settings for Point-to-Point/Multipoint	Off, On Off, On
	IP:Mode (Communication) ⁴⁾	Total Bandwidth Communication Bit Rate ¹⁾ Audio Mode ¹⁾ Far End Camera Control ²⁾ H.239 H.239 Ratio Screen Size ¹⁾ Video Mode ¹⁾ Video Frame ¹⁾	128Kbps, 384Kbps, 512Kbps, 768Kbps, 1Mbps, 2Mbps, 3Mbps, 4Mbps, Other 128Kbps, 384Kbps, 512Kbps, 768Kbps, 1Mbps, 2Mbps , 3Mbps, 4Mbps, Other G.711, G.722, G.728, MPEG4 On, Off On, Off 2/3, 1/2, 1/3 720, W4CIF, W432P, WCIF, 4CIF, CIF, QCIF, AUTO H.261, H.263+, H.264 15fps, 30fps, 60fps, AUTO
	ISDN	Individual Settings for Point-to-Point/Multipoint	Off, On
	ISDN:Mode (Communication) ⁴⁾	ISDN Bandwidth (Dial) ³⁾ ISDN Bandwidth (Answer) ³⁾ Audio Mode ³⁾ Far End Camera Control ³⁾ H.239 H.239 Ratio Restrict Screen Size ³⁾ Video Mode ³⁾ Video Frame ³⁾	1B(64K), 2B(128K) , 3B(192K), 4B(256K), 5B(320K), 6B(384K), 8B(512K), 12B(768K) 1B(64K), 2B(128K) , 3B(192K), 4B(256K), 5B(320K), 6B(384K), 8B(512K), 12B(768K) G.711, G.722, G.728, MPEG4 On, Off On, Off 2/3, 1/2, 1/3 Auto, 56K W4CIF, W432P, WCIF, 4CIF, CIF, AUTO H.261, H.263+, H.264 15fps, 30fps, AUTO

Continued on next page

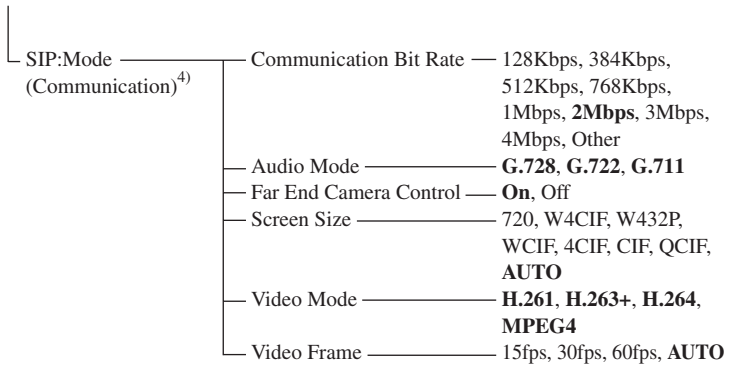

- 1) When “Individual Settings for Transmission/Reception” or “Individual Settings for Point-to-Point/Multipoint” is set to “On” on the IP page, the item is set up for transmission, reception, point-to-point and multipoint individually.
- 2) When “Individual Settings for Point-to-Point/Multipoint” is set to “On” on the IP page, the item is set up for point-to-point and multipoint individually.
- 3) When “Individual Settings for Point-to-Point/Multipoint” is set to “On” on the ISDN page, the item is set up for point-to-point and multipoint individually.
- 4) The page number after “Communication2” varies with the on/off setting in “Individual Settings for Transmission/Reception” or “Individual Settings for Point-to-Point/Multipoint”.

F Audio (page 62)	Basic Setup1 (Audio1)	Audio Input	MIC, AUX, MIC+AUX
		Input Select (MIC)/	MIC(A1/A3), MIC (Camera) ,
		Input Select (AUX)	AUDIO
		Echo Canceller	On , Off
		Lip Sync	Auto , Off
		Recording Mute	Off , On
		Input Mode	Stereo, Monaural
	Output Mode	Stereo , Monaural	
	Basic Setup2 (Audio2)	AUX Local Monitor Out	On , Off
		Reversed MIC Inputs	Off , On
		Audio Input Delay Setting	Default-100ms, Default-50ms, Default , Default+50ms, Default+100ms, Custom
		Audio Input Delay	
		Audio Output Delay Setting	Default-100ms, Default-50ms, Default , Default+50ms, Default+100ms, Custom
		Audio Output Delay	
		REC OUT Mode	Stereo , Monaural 2ch
	Sound Effect (Audio3)	Lens Cover Mic On/Off Function	On, Off
		Beep Sound	Loud, Medium , Quiet, Off
		Sound Effect	Loud, Medium , Quiet, Off
Dial Tone		Loud, Medium , Quiet, Off	
	Ringer Tone	Loud, Medium , Quiet, Off	

G Video (page 65)	Basic Setup (Video1)	Video Input	Camera , RGB
		Presentation Screen	Full Screen , PandP, Side by Side
		Monitor Output	Single , Dual
		RGB Monitor Output Format	SXGA , XGA, WXGA
		Blanking Period	Long, Medium, Short
	Custom Input Label (Video2)	Custom Input Label (Camera)	
		Custom Input Label (RGB)	
	Link to Mic (Video3)	Link to Audio Input	Off , On
		Video Input	Camera , RGB
		Audio Input	MIC , AUX, MIC+AUX
Input Select (MIC)/ Input Select (AUX)		MIC(A1/A3), MIC (Camera) , AUDIO	

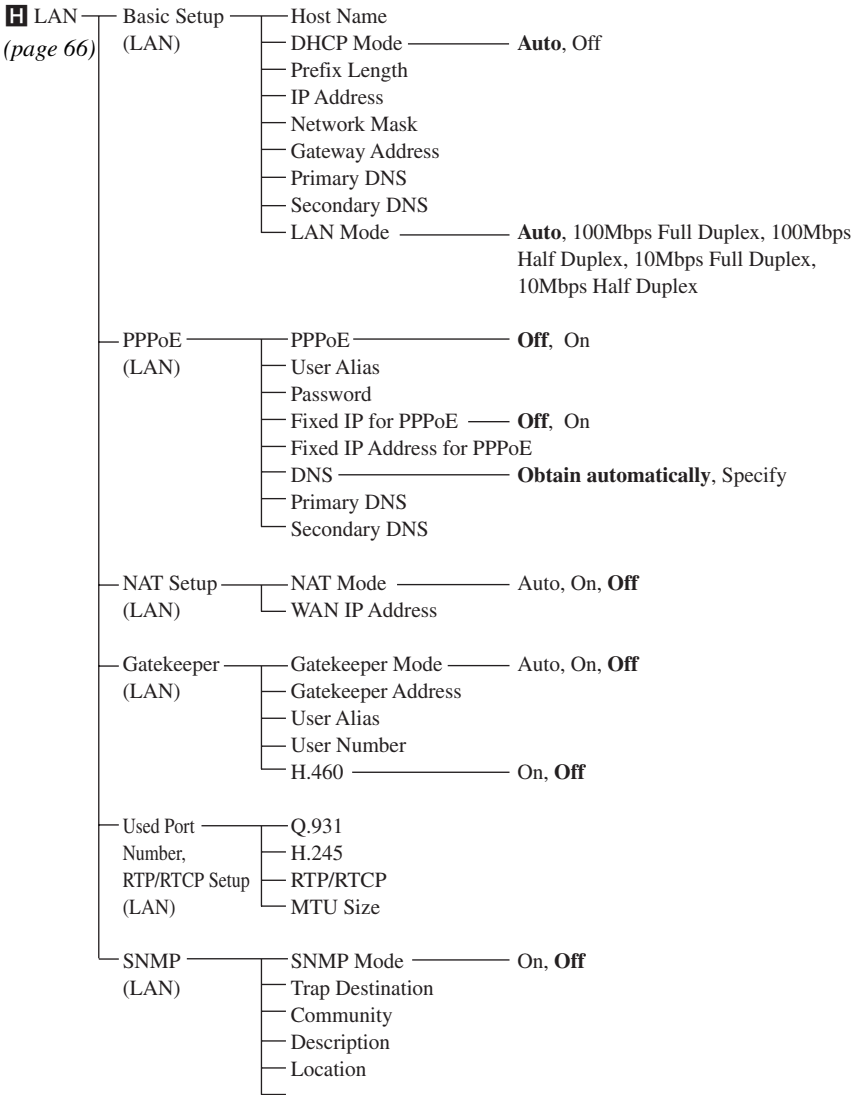



- I** QoS (page 69)
 - Basic Setup (QoS1)
 - Adaptive Rate Control (ARC) — **On, Off**
 - Auto Bandwidth Detection — **On, Off**
 - TCP Port Number
 - UDP Port Number
 - Packet Resend Request(ARQ) — **On, Off**
 - ARQ Buffering Time — 300ms, 150ms, 80ms, **Auto**, Custom
 - ARQ Buffering Time
 - Forward Error Correction(FEC) — **On, Off**
 - FEC Redundancy — 8, 4, 2, **Auto**
 - Audio Duplex Transmission — **On, Off**
 - Re-Order/Shaping (QoS2)
 - Re-Order — **On, Off**
 - Re-Order Buffer — **Auto**, 1, 2, Custom
 - Re-Order Buffer Rate
 - Shaping — **On, Off**

- J** TOS (page 70)
 - TOS Data Type — **Video**, Audio, Data, Presentation
 - TOS — **Off**, IP Precedence, DSCP
 - Precedence
 - Low Delay — **On, Off**
 - High Throughput — **On, Off**
 - High Reliability — **On, Off**
 - Minimum Cost — **On, Off**
 - DSCP

- K** SIP (page 71)
 - Basic Setup (SIP)
 - SIP Server Mode — **On, Off**
 - Transport Protocol — **TCP, UDP**
 - Port Number
 - SIP Domain
 - Registered User Name
 - Password
 - SIP Server Address
 - SIP Server Port

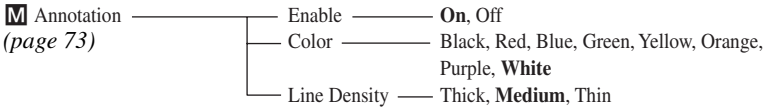
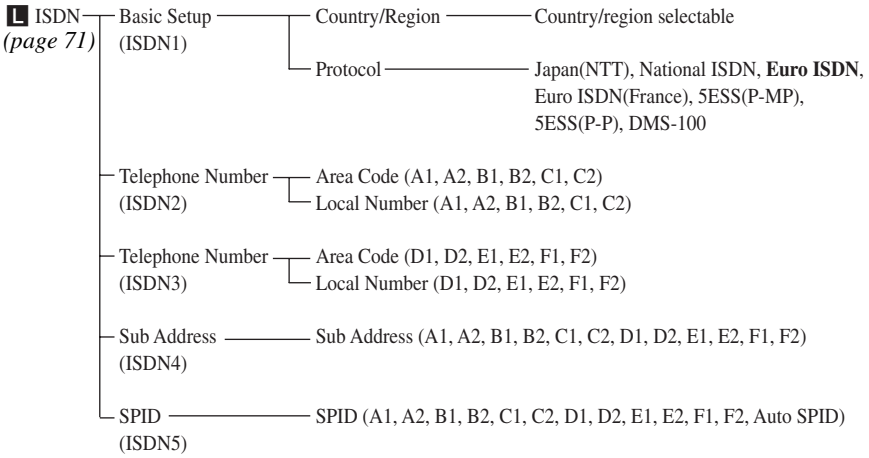

N Camera (page 74)

General <i>(page 74)</i>	Device Setup	Terminal Name	
	(General1)	Standby Mode	On, Off
		Standby Time	1-99 minutes
		Last Number Registration	Off, On
		Control by Far End	On, Off
		Language	Japanese, English, French, German, Spanish, Italian, Simplified Chinese, Portuguese, Traditional Chinese, Korean, Dutch, Danish, Swedish, Finnish, Polish, Russian, Arabic, Thai, Norwegian, Turkish, Welsh, Czech, Hungarian
	Clock Set	NTP	On, Off
	(General2)	Primary NTP Server	
		Secondary NTP Server	
		Time Zone	
		Clock Display Pattern	Year/Month/Day, Month/Day/Year, Day/Month/Year, Year-Month-Day, Day.Month.Year
		Date	
		Time	
		Time Update	Execute
	Menu Screens	Display Time in	Off, Time Display , Current Time
	(General3)	Communication	
		Display Terminal Name	Off, Always Show, Show Temporarily
		Guide	On, Off
	Display Indicator	On, Off	
	Communication Mode	On, Off	
	Display		
	Display On-Screen	On, Off	
	Keyboard		
	Menu Transparency	High, Medium , Low	

Continued on next page

Function Keys in Communication (General4)	F1	Far/Near, Camera, RGB, No Operation
	F2	Camera, , RGB, No Operation
	F3	Camera, RGB, Zoom (RGB), No Operation
	F4	Camera, RGB, No Operation

P Home Menu (page 76)	Home Menu1 (Home Menu1)	Clock Display	On, Off
		Local Terminal Name	On, Off
		Number Display	IP:Address, SIP:User Name, SIP:Address, GK:User Alias, GK:User Number, NAT:Address, No Display
		Terminal Status	On, Off
		Warning Messages	On, Off
	Home Menu2 (Home Menu2)	Connect Button Display	Simple, Individual, Off
		Phone Book Button	On, Off
		History Button	On, Off
		Detailed Dial Button	On, Off
		Camera Button	On, Off
		Tools Button	Off, On
		One-Touch Dial	On, Off
	Direct Dial	Off, On	
	Home Menu3 (Home Menu3)	Video Input Display	On, Off
		Audio Input Display	On, Off
		Audio Level Meter	On, Off
		Volume	On, Off
		LAN Status	On, Off
		ISDN Status	On, Off

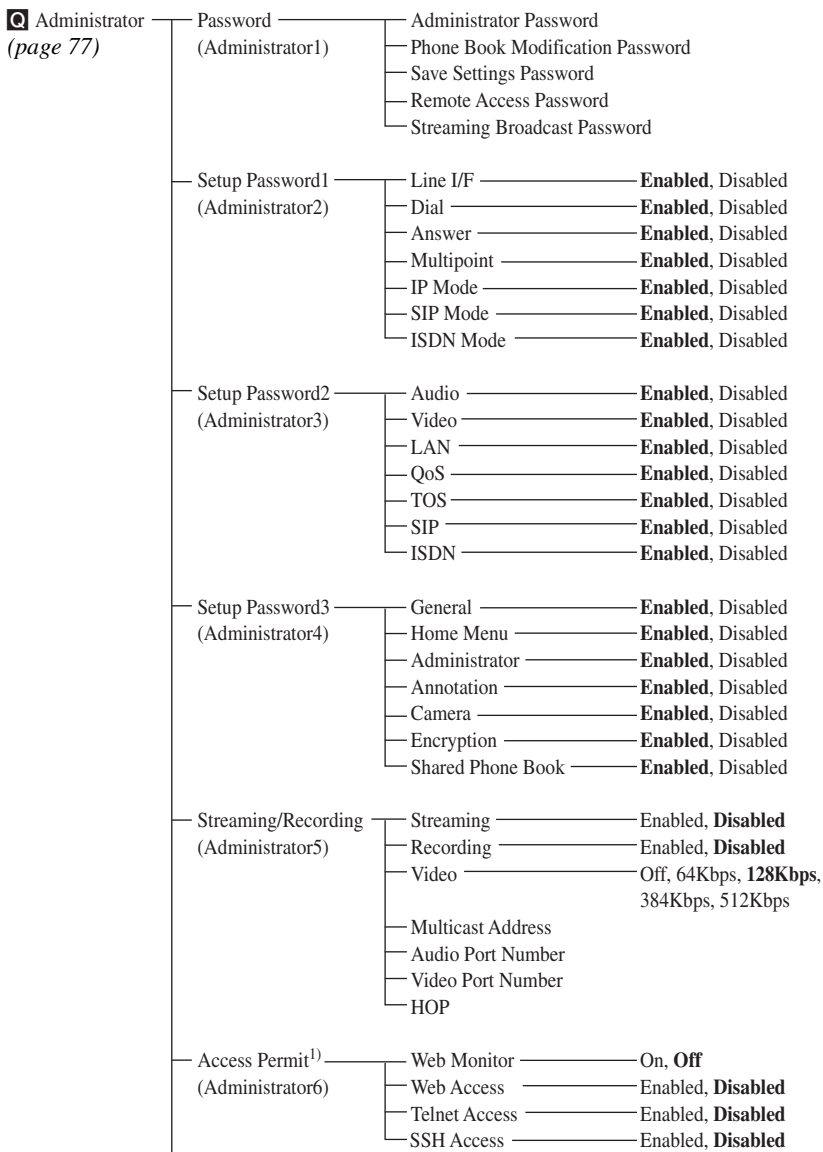

Continued on next page

1) The items on the Access Permit page are displayed and can be set only when “Internet Protocol” is set to “IPv4”.

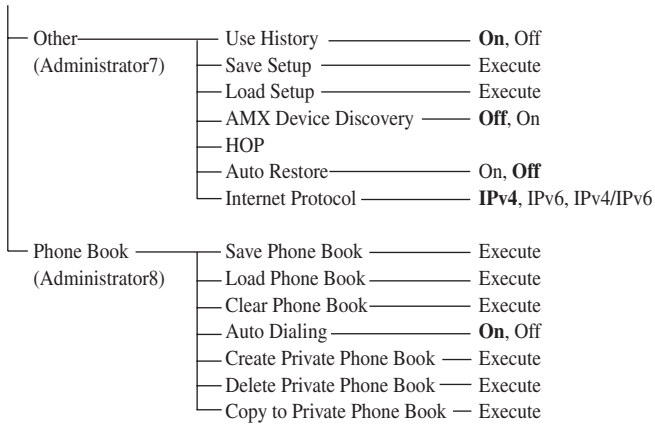

R Encryption ————— Encryption Mode — **Off**, Connect Priority, Encrypt Priority
 (page 82)

S Shared Phone Book ————— SPB Mode ————— On, Off
 (page 82)

- SPB Server Address
- SPB Server Password

Computer display function menu

