

SMART Board® 7000 with iQ



The SMART Board® 7000 series interactive display with iQ is the hub of your classroom. iQ technology connects devices, lesson content and pedagogically relevant software to create a cohesive educational experience. PC-free embedded computing provides one-touch access to a diverse suite of SMART applications—Notebook lessons, amp workspaces, lab gamification activities and whiteboard—and collaborative tools, such as wireless screen sharing and a web browser. There’s no need for wires, cables or manual software and firmware updates.

Waking up the display

The display’s presence detection sensor can detect people up to 16’ (5 m) away when the display is sleeping. When the sensor detects people, the display is ready to turn on. To turn on the display, press the **Power** button  on the convenience panel or pick up a pen or the eraser.

Using the launcher

Use the launcher to open the Whiteboard, SMART Notebook® Player, Workspaces, Activities, Input and Screen Share apps, and to access settings:

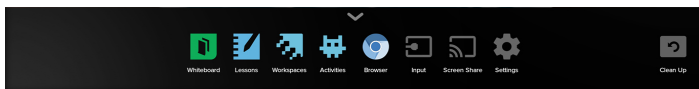

To show the launcher

Press the **Home** button  at the bottom of the screen.

To hide the launcher

Select an app, press the **Home** button  or tap anywhere on the screen.

Whiteboard

Using Whiteboard, you can write and erase notes on the display just as you do on a traditional dry erase board. You can also save your notes for later reference and share them using the SMART kapp® app.

To start a Whiteboard session

Show the launcher and press **Whiteboard** .

To write in digital ink

1. Pick up a pen.
2. Use the pen to write in digital ink.
3. Return the pen to its holder to recharge it.

To erase digital ink

Move a pen’s eraser over the digital ink.

OR

Move the eraser over the digital ink.

OR

Move your fist or palm over the digital ink.

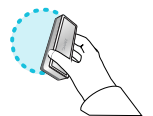
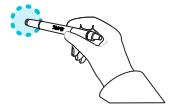







To pan

Press the screen and move your finger in any direction.



TIP

You can use the following tools during your Whiteboard session:

-  Return to the previous screen.
-  Connect your smart phone or other mobile device to the display using the SMART kapp app.
-  Disconnect your smart phone or other mobile device.
-  Save snapshots of the whiteboard to your smart phone or other mobile device.
-  Save all notes in the Whiteboard Library and clear the Whiteboard.
-  View saved notes.

SMART Board 7000 with iQ

SMART Notebook Player



Use SMART Notebook Player to open, view and interact with [SMART Notebook software](#) files. Notebook Player makes it easy to present SMART Notebook files and play [SMART lab™](#) activities on the display.

You can also install the Notebook Player app on your iOS device to view and control SMART Notebook files from the device.

To open SMART Notebook files stored on a USB drive



1. Copy the SMART Notebook files to the USB drive.
2. Insert the USB drive into one of the USB receptacles on the convenience panel.
3. Show the launcher and press **Player** .
4. Select the file you want to open.

To open SMART Notebook files using Share To Board

1. Show the launcher and press **Player** .
2. Press the **Share**  button.
A four-digit code appears.
3. On a computer, open the SMART Notebook file you want to share and select **File > Share**.
4. Click **Share with a SMART Board**.
5. Click **ADD BOARDS**, enter the four-digit code that appears on the display, and then click **Connect**.
OR
Select the display you want to share the file with, and then click **Share Now**.
6. Select the file's thumbnail to open the file on the display.



TIP

Move between pages and documents by selecting the **Page Sorter**  or **Notebook Player Lobby**  buttons at the bottom of the screen.

Workspaces

Workspaces allows you to access [SMART amp® collaborative learning software](#) on the display. SMART amp is an easy-to-use cloud-based application that enables you and your students to collaborate in real time.

To use Workspaces

1. Show the launcher and press **Workspaces** .
2. Sign in to SMART amp and use the software to collaborate with your students.

Convenience panel

The convenience panel contains buttons for turning the display on and off, controlling the volume and freezing and unfreezing the screen. It also includes connectors for USB drives and other peripherals and a computer or other input source.

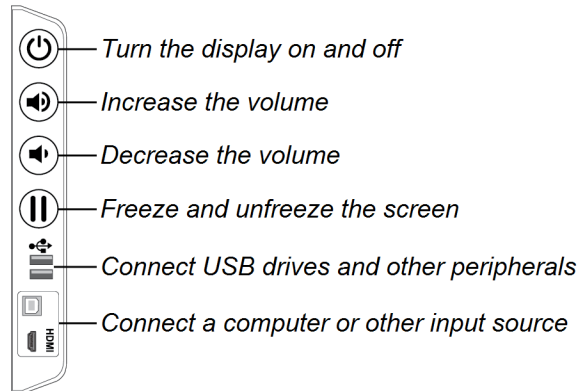

Activities

Use Activities to view activities created by teachers like you using SMART lab on the display. These activities help students memorize concepts and facts, identify objects, learn vocabulary definitions, and more.

To use Activities

1. Show the launcher and press **Activities** .
2. Scroll to and select the activity you want to view.
3. Press **START**.

Browser

You can use Browser to view web content on the display.

To use Browser

1. Show the launcher and press **Browser** .
2. Use Browser as you would use a web browser on your computer or mobile device.



SMART Board 7000 with iQ

Input

You can use the connector panel on the right side of the display or the convenience panel to connect a room computer, guest laptops and other input sources.

Connector panel

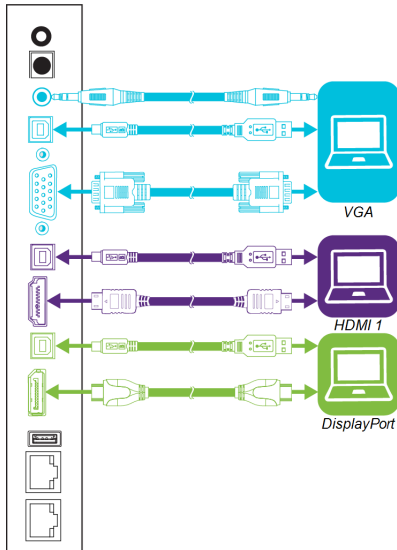

Convenience panel

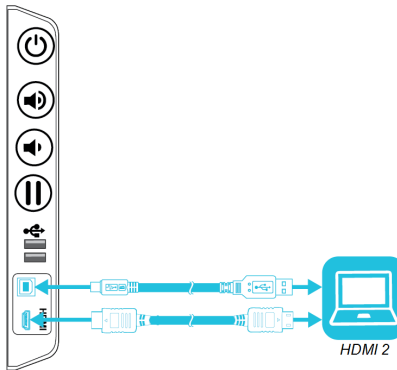





After you've connected computers and other input sources to the display, switch between these input sources by showing the launcher, pressing **Input** , and then selecting an input source.

Screen Share

You can share content from computers and mobile devices on the display wirelessly using Screen Share.

Screen Share supports the following devices:

-  Chromebook™ laptops, using Google™ Cast Chrome™ browser extension
-  Windows® computers, using Google Cast Chrome browser extension or [AirParrot](#)
-  Mac computers and iOS devices, using AirPlay
-  Android™ devices, using Cast Screen

To use Screen Share

1. Show the launcher and press **Screen Share** .
2. Share the computer or mobile device's screen following the instructions in [Using Screen Share](#).

Cleaning up the display

After you've finished using the display, show the launcher and press **Clean Up**  to clean up the display for the next user.

More information

For more information about the SMART Board 7000 series interactive display with iQ, browse to the following page or scan the QR code.

support.smarttech.com/docs/redirect/?product=smartboard7000iq



For more information, visit education.smarttech.com

For more training, visit smarttech.com/training

© 2017 SMART Technologies ULC. All rights reserved. SMART Board, SMART Notebook, SMART lab, SMART amp, SMART kapp, smarttech, the SMART logo and all SMART taglines are trademarks or registered trademarks of SMART Technologies ULC in the U.S. and/or other countries. Google, Android, Chrome and Chromebook are trademarks of Google Inc. All other third-party product and company names may be trademarks of their respective owners. Contents are subject to change without notice. 07/2017.

 smarttech.com/docfeedback/171162

smarttech.com/kb/171162